

Neck

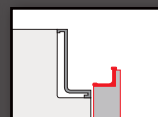

Lux



Bridge



Head



ANTA:  
DOOR:

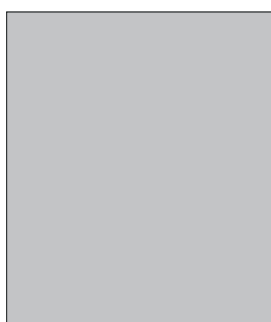

SP: **22** MM  
TH:



⊘ Head  
Lux

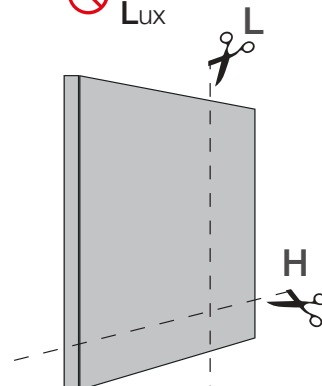

ANTA SP.22 MM  
ABBINABILE CON:  
TH. 22 MM DOOR  
MATCHABLE WITH:

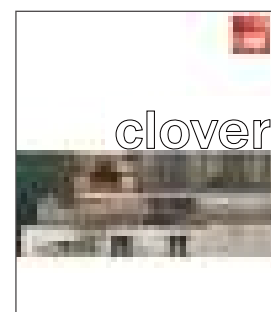
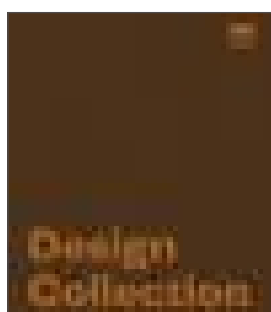

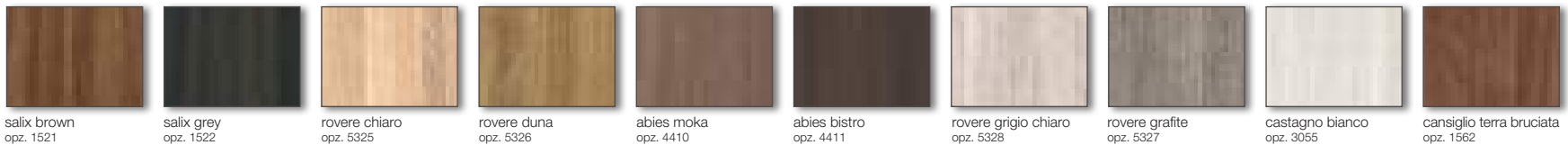

salix brown opz. 1521    salix grey opz. 1522    rovere chiaro opz. 5325    rovere duna opz. 5326    abies moka opz. 4410    abies bistro opz. 4411    rovere grigio chiaro opz. 5328    rovere grafite opz. 5327    castagno bianco opz. 3055    cansiglio terra bruciata opz. 1562

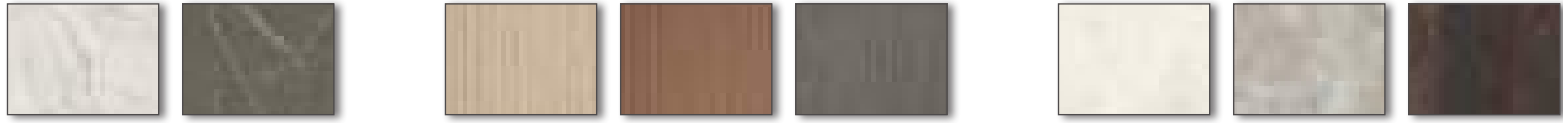

marmo white yule opz. 9645    marmo venato grigio opz. 8870    ottone chiaro opz. 7707    rame brunito opz. 8868    peltro opz. 9666    platino ossidato opz. 9661    nichel ossidato opz. 9660    oxide opz. 8871



bianco cristallo malta opz. 7445    grigio nebbia malta opz. 9626    juta malta opz. 8863    lavagna malta opz. 9627    juta stone opz. 9634    grey stone opz. 9635    bronze stone opz. 8869    kea opz. 9646



bianco assoluto opz. 7450    grigio chiaro opz. 9640    dove grey opz. 8971    antracite opz. 9643    rigatino verticale arena opz. 9647V    rigatino orizzontale arena opz. 9647O    rigatino verticale laguna opz. 9648V    rigatino orizzontale laguna opz. 9648O

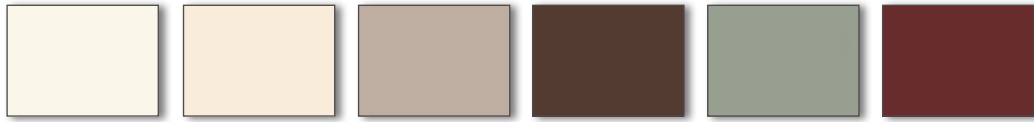

porcellana opz. 7703N    light cream opz. 7706    ecru opz. 9641    ebano opz. 8872    verde marino opz. 8402N    rosso cardinale opz. 8123

## Melaminico Melamine



bianco opaco opz. 7405    bianco neve opaco opz. 7407    desert opaco opz. 8941    polvere opaco opz. 9529    beige colorado opaco opz. 7777    antracite opaco opz. 9558    nero opaco opz. 7895    grigio minerale opaco opz. 9523    blu cobalto opaco opz. 8383

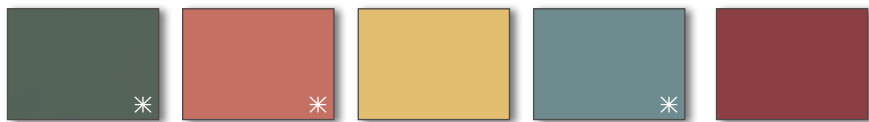

verde malga opaco opz. 8477    rosso cammeo opaco opz. 8160    giallo cadmio opaco opz. 8255    verde nilo opaco opz. 8475    rosso velvet opaco opz. 8168

\* disponibile anche in versione **Bordo Bicolore Effetto Vetro**  
also available in **Glass Effect Bicolour Edge** version



bianco lucido opz. 7406    desert lucido opz. 8942    polvere lucido opz. 9530    antracite lucido opz. 9559    nero lucido opz. 7896    beige colorado lucido opz. 7778    grigio minerale lucido opz. 9524    rosso cammeo lucido opz. 8164

## Laccato UV UV lacquered

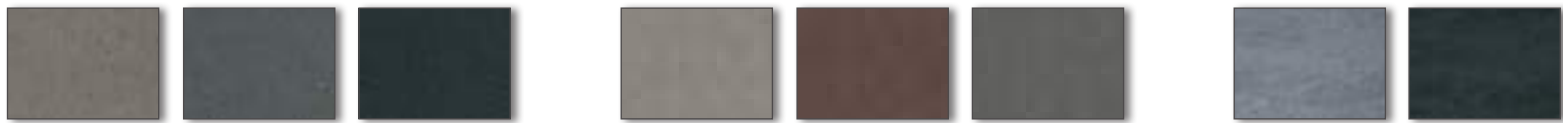

areia beige opz. MT02    areia grigio opz. MT03    areia nero opz. MT04    gipso verde opz. MT22    gipso rosso opz. MT24    gipso grigio opz. MT23    selce grigio chiaro opz. MT13    selce nero opz. MT14

## Mathera



metal brass opz. 8848    metal brown opz. 8849    metal dark night opz. 7871

## PET



rovere naturale opz. 5442    rovere grey opz. 5443    rovere moscato opz. 5444    rovere fumè opz. 5445    rovere bianco opz. 5441    rovere nero opz. 5446

## Impiallacciato WOOD Veneered WOOD



caravella light    caravella dark

## Laminato Cannettato Reed-effect laminate



telaio titanio    telaio nero black frame    telaio silver dark    telaio ottone    telaio rame brunito    telaio terra d'ombra

## Telaio alluminio Aluminium frame



## MADE IN ITALY: NORMA UNI 11674

La norma tutela l'acquirente garantendo l'origine italiana e le prestazioni di sicurezza e durata del prodotto, entrambe verificate periodicamente da uno dei più importanti laboratori di prova e certificazione per il legno-arredo in Italia: COSMOB.

## MADE IN ITALY: STANDARD UNI 11674

This standard protects purchasers by guaranteeing the Italian origin, safety performance and useful life of products, both periodically verified by one of the leading testing and certification labs for wooden furnishings in Italy: COSMOB.



## GREENGUARD

Il Programma di Certificazione GREENGUARD certifica che tutte le strutture dei prodotti a marchio LUBE e CREO sono conformi agli standard più rigorosi in termini di livelli di emissione di Composti Organici Volatili (COV) emessi da mobili, superfici e vernice oltre ad altre sostanze chimiche nocive negli ambienti interni.

## GREENGUARD

The GREENGUARD certification programme certifies that all structures of LUBE and CREO products comply with the strictest standards in terms of emissions of volatile organic compounds (VOCs) from furniture, surfaces and coatings, as well as other harmful chemical substances in interior environments.



## PANNELLO ECOLOGICO

Le strutture dei mobili LUBE e CREO sono realizzate con pannelli composti da legni riciclati al 100%, certificati dal Consorzio Pannello Ecologico e con materiali a basso impatto ambientale, certificati per la bassa emissione di formaldeide.

## ECOLOGICAL PANELS

LUBE and CREO structures are created with panels made from 100% recycled wood, certified by the Eco-Panel Consortium, and from environmentally friendly materials, certified for low formaldehyde emissions.



## GRUPPO LUBE ECOLOGIC

Il Gruppo LUBE utilizza per i componenti delle cucine (tutte le strutture, alcune ante e alcuni complementi), materiale conforme al regolamento EPA TSCA TITLE VI, uno dei più severi in merito alle normative di salvaguardia ambientale.

## ECOLOGICAL PANELS

The LUBE Group uses for kitchen components (all carcasses, some doors and some accessories), material that complies with the EPA TSCA TITLE VI regulation, one of the strictest regarding environmental protection regulations.



## SOSTENIBILITÀ AMBIENTALE

Lube Industries srl è dotata di Sistemi di Gestione per l'Efficienza Ambientale, per la Qualità e per la Salute e la Sicurezza sul Lavoro, in conformità alle norme: UNI EN ISO 14001, UNI EN ISO 9001 e UNI EN ISO 45001.

## ENVIRONMENTAL SUSTAINABILITY

Lube Industries S.r.l. implements management systems for environmental efficiency, quality, and occupational health and safety, in conformity to the following standards: UNI EN ISO 14001, UNI EN ISO 9001 and UNI EN ISO 45001.



## FSC®

La certificazione FSC® rappresenta il principale meccanismo di garanzia sull'origine del legno o della carta, con questa certificazione Lube Industries ha deciso di rendere noto il suo impegno nei confronti dell'ambiente e si schiera contro il disboscamento incontrollato e il taglio illegale di foreste.

## FSC®

FSC® certification is the leading mechanism guaranteeing the origin of wood and paper. With this certification, Lube Industries has decided to demonstrate its commitment to the environment and stand against uncontrolled deforestation and illegal felling.

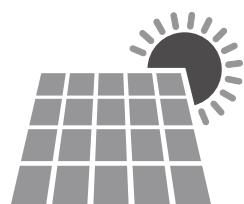

## FOTOVOLTAICO

Energia pulita per prodotti di qualità. Un impianto fotovoltaico, installato nella sede aziendale, copre la superficie di 40.800 mq ed eroga una potenza di 6,2 MWp. L'energia prodotta quotidianamente dai pannelli solari, circa 6000 KWh, è in grado di soddisfare il fabbisogno dei processi produttivi aziendali.

## PHOTOVOLTAICS

Clean energy for high-quality products. A photovoltaic plant, installed at the company headquarters, covers an area of 40,800 m2 and has a power output of 6.2 MWp. The energy generated daily by the solar panels, approximately 6,000 KWh, is enough to meet the company's production needs.

# STRUTTURE

## CARCASSES



bianco (opz.001)  
schiena e ripiano bianco  
(opz.001)  
white (opt.001)  
white back panel and shelf  
(opt.001)



visone (opz.948M)  
schiena e ripiano visone  
(opz.948M)  
mink (opt.948M)  
mink back panel and shelf  
(opt.948M)



lavagna (opz.9620)  
schiena e ripiano lavagna  
(opz.9620)  
slate grey (opt.9620)  
slate grey back panel and shelf  
(opt.9620)



fango (opz.8860)  
schiena e ripiano fango  
(opz.8860)  
mud (opt.8860)  
mud back panel and shelf  
(opt.8860)



conchiglia (opz.8910)  
schiena e ripiano conchiglia  
(opz.8910)  
shell (opt.8910)  
shell back panel and shelf  
(opt.8910)



argilla (opz.9690)  
schiena e ripiano argilla  
(opz.9690)  
clay (opt.9690)  
clay back panel and shelf  
(opt.9690)



ANTA  
DOOR

STRUTTURA CONSIGLIATA  
RECOMMENDED CARCASS



Per finiture ante e strutture consigliate vedi pagine 32 / 45  
For doors finishes and recommended carcasses see pages 32 / 45

## MENSOLE P. 31-61 COME STRUTTURE

### D. 31-61 SHELVES AS CARCASSES

## MENSOLE P. 31-61 COME ANTE

### D. 31-61 SHELVES AS DOORS



bianco (opz.001)  
white (opt.001)



visone (opz.948M)  
mink (opt.948M)



mensole in melaminico  
melamine shelves

Per le finiture vedi pagine 32 / 35  
For finishes see pages 32 / 35



lavagna (opz.9620)  
slate grey (opt.9620)



fango (opz.8860)  
mud (opt.8860)

mensole laccate uv  
uv lacquered shelves

Per le finiture vedi pagine 36 / 37  
For finishes see pages 36 / 37



conchiglia (opz.8910)  
shell (opt.8910)



argilla (opz.9690)  
clay (opt.9690)

mensole mathera  
mathera shelves

Per le finiture vedi pagine 40 / 41  
For finishes see pages 40 / 41



mensole pet  
pet shelves

Per le finiture vedi pagina 42  
For finishes see page 42



mensole wood  
wood shelves

Per le finiture vedi pagine 44 / 45  
For finishes see pages 44 / 45

## zoccoli in pvc pvc plinths



acciaio (opz.407)  
steel (opt.407)



di serie  
standard

## zoccoli in alluminio aluminium plinths



alluminio finitura titanio  
ossidato (opz.414)  
aluminium titanium oxidized  
finish (opt.414)

## zoccoli in alluminio verniciati a polvere finitura opaca aluminum plinths height powder coated matt finish

### COLORI FREDDI OPACHI SOFT SOFT MATT COLD COLOURS



bianco assoluto (opz.740S)  
absolute white

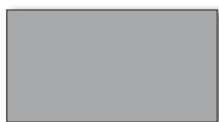

grigio traffico (opz.9511)  
traffic grey

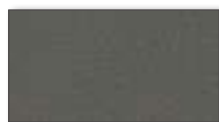

silver dark (opz.9507)  
dark silver

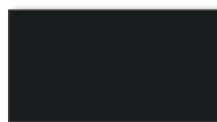

nero (opz.7892)  
black

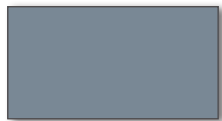

azzurro nube (opz.8379)  
cloud blue

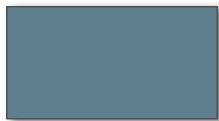

azzurro ottanio (opz.8385)  
teal blue

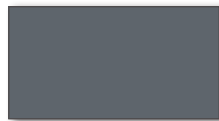

grigio bromo (opz.9533)  
bromine grey

### COLORI CALDI OPACHI SOFT SOFT MATT HOT COLOURS



lino (opz.9513)  
linen

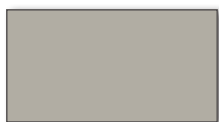

grigio kenya (opz.9501)  
kenya grey

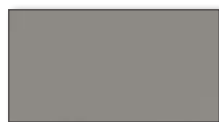

grigio selce (opz.SE)  
flint grey

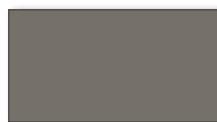

grigio piombo (opz.9537)  
lead grey

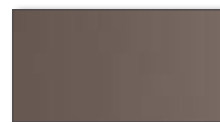

terra d'ombra (opz.955T)  
shadow earth

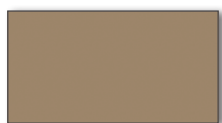

ottone (opz.7761)  
brass



umber (opz.955U)  
umber



cuoio (opz.8887)  
leather

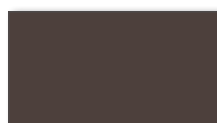

ghisa (opz.9509)  
cast iron

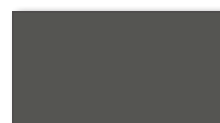

fumo (opz.9531)  
smoke



giallo digione (opz.8257)  
digione yellow



oro (opz.AU)  
gold

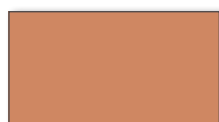

cotto (opz.8887)  
cooked



rame (opz.8167)  
copper



rame brunito (opz.8168)  
burnished copper



rosso persia (opz.8165)  
persia red

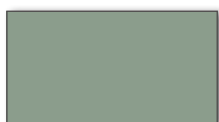

verde celadon (opz.8485)  
celadon green



rosso velvet (opz.8169)  
velvet red

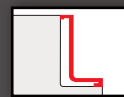

# Neck

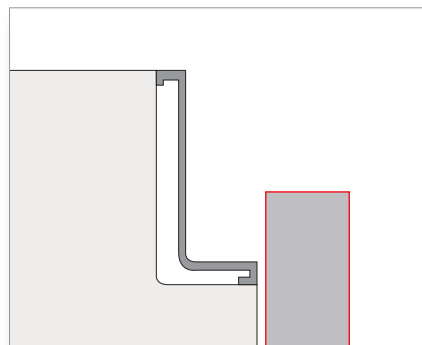

## ANTA SQUADRATA SENZA PROFILO

SQUARED DOOR WITHOUT  
PROFILE

# LUX

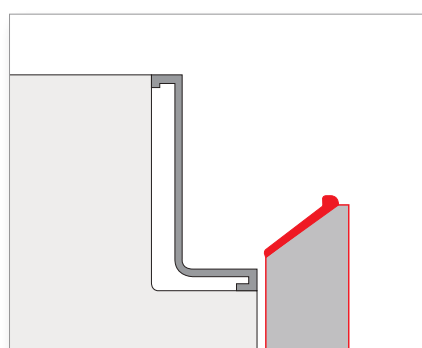

## ANTA CON PROFILO INCLINATO

(OPZ. PI+ COD. COLORE)

DOOR WITH INCLINED  
PROFILE

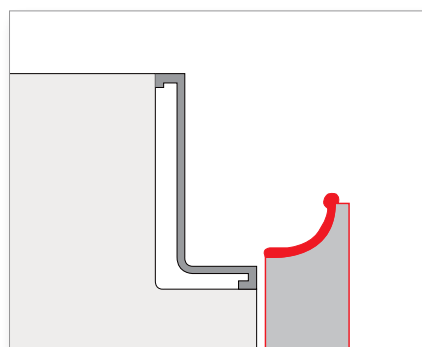

## ANTA CON PROFILO CURVO

(OPZ. PC+ COD. COLORE)

DOOR WITH CURVED  
PROFILE

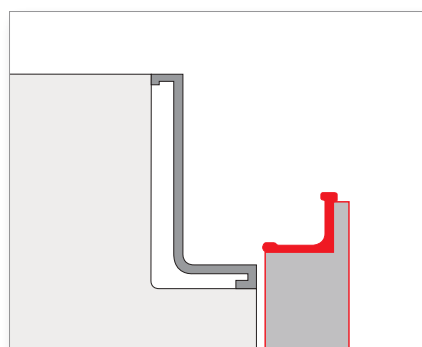

## ANTA CON PROFILO AD "L"

(OPZ. PL+ COD. COLORE)

DOOR WITH "L" SHAPED  
PROFILE

### FINITURE PROFILI E GOLE SPAZZOLATI FINGER RAILS AND PROFILES BRUSHED FINISHES



titanio ossidato (opz.414)  
titanium oxidized

### FINITURE PROFILI E GOLE VERNICIATI A POLVERE OPACHI MATT FINGER RAILS AND PROFILES POWDER COATED FINISHES

#### COLORI FREDDI OPACHI SOFT SOFT MATT COLD COLOURS



bianco assoluto (opz.740S)  
absolute white



grigio traffico (opz.9511)  
traffic grey



silver dark (opz.9507)  
dark silver



nero (opz.7892)  
black



azzurro nube (opz.8379)  
cloud blue



azzurro ottanio (opz.8385)  
teal blue



grigio bromo (opz.9533)  
bromine grey

#### COLORI CALDI OPACHI SOFT SOFT MATT HOT COLOURS

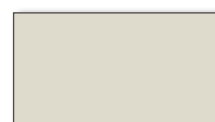

lino (opz.9513)  
linen



grigio kenya (opz.9501)  
kenya grey



grigio selce (opz.SEL)  
flint grey

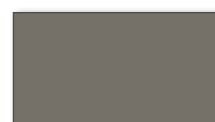

grigio piombo (opz.9537)  
lead grey



terra d'ombra (opz.955T)  
shadow earth



umber (opz.955U)  
umber



ottone (opz.7761)  
brass



cuoio (opz.8897)  
leather



ghisa (opz.9509)  
cast iron



fumo (opz.9531)  
smoke



giallo digione (opz.8257)  
digione yellow



oro (opz.AU)  
gold



cotto (opz.8887)  
cooked



rame (opz.8167)  
copper



rame brunito (opz.8168)  
burnished copper

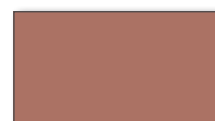

rosso persia (opz.8165)  
persia red

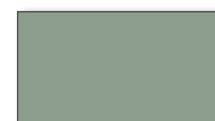

verde celadon (opz.8485)  
celadon green



rosso velvet (opz.8169)  
velvet red

# Bridge

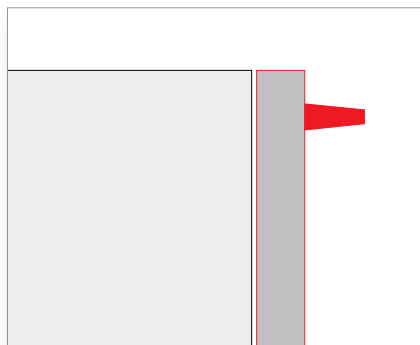

**ANTA CON MANIGLIA  
FRONTALE**  
DOOR WITH FRONT HANDLE

# Head

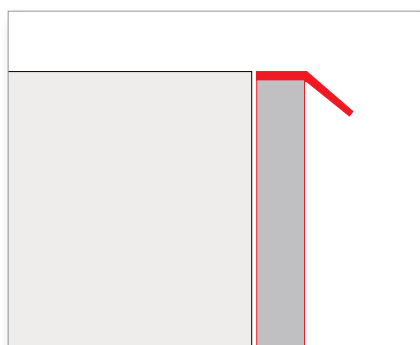





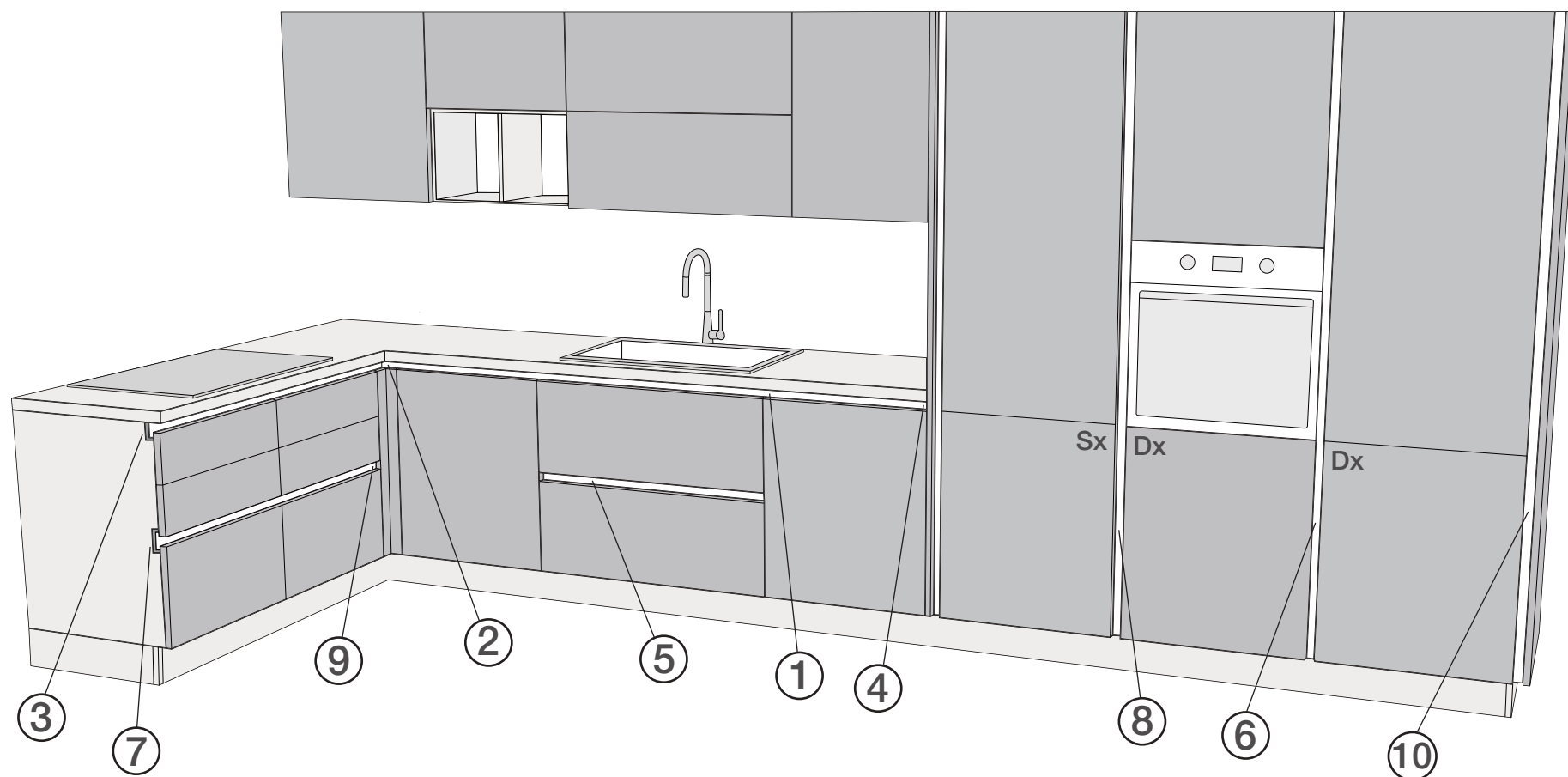
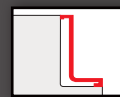

**ANTA CON MANIGLIA  
APPLICATA IN TESTA**  
DOOR WITH TOP-MOUNTED HANDLE



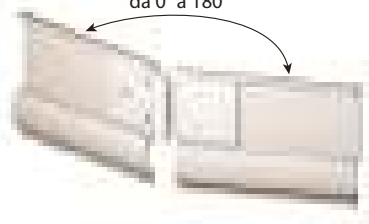

	COD.		COD.
<p><b>1</b></p> <p><b>Gola sottotop tipo "A"</b> Type "A" undermount finger rail</p> <p style="text-align: right;">al ml per lm</p>	G950010	<p><b>2</b></p> <p><b>Angolo interno a 90° per gola tipo "A"</b></p> <p style="text-align: right;">cadauno each</p>	G950050
<p><b>3</b></p> <p><b>Terminale aperto dx o sx per gola tipo "A" da utilizzare a fine composizione in presenza di fianco struttura non rifinito.</b> RH or LH open end for type "A" finger rail to be placed at the end of the composition in presence of unfinished structure side.</p> <p style="text-align: right;"><b>terminale DX</b> RH end <b>terminale SX</b> LH end</p>	G950021 G950022	<p><b>4</b></p> <p><b>Terminale chiuso dx o sx per gola tipo "A" da utilizzare solo tra basi e colonne o a fine composizione in presenza di fianco struttura rifinito come anta senza scassi per gola.</b> RH or LH closure for type "A" finger rail to be placed only between base units and column or at the end of the composition in presence of structure side finished as a door without recess for finger rail.</p> <p style="text-align: right;"><b>terminale DX</b> RH end <b>terminale SX</b> LH end</p>	G950031 G950032



	COD.			COD.	
<p><b>Coppia angolari per kit raccordo base angolo 110x110</b>  <b>Obbligatorii</b>            Couple corner piece for fitting kit corner base unit 110x110  <b>Obbligatori</b></p>  <p>SX LH      DX RH</p> <p><b>in alluminio</b> aluminium</p> <p><b>angolare DX</b> RH corner piece</p> <p><b>angolare SX</b> LH corner piece</p>				<p><b>2</b></p> <p><b>Angolare con snodo per unione fuori squadra per gola tipo "A"</b>            Corner piece with joint for out-of-plumb joining for type "A" finger rail</p>  <p>da 0° a 180°</p>	
	G950058				
	G950059			G950060	
<p><b>5</b></p> <p><b>Gola intermedia tipo "B" cestoni</b>            Type "B" intermediate finger rail</p>  <p><b>al ml</b> per lm</p>				<p><b>6</b></p> <p><b>Mezza gola verticale tipo "C" (completa di distanziale)</b>            Type "C" half vertical finger rail (complete with spacer)</p>  <p>sezione mezza gola tipo "C" cross section of type "C" finger rail</p> <p>Piedi H 13 H 96 H 132 H 204 H 228</p> <p>Piedi H 6 H 108 H 144 H 216</p>	
	G950110			G950310	
				G950330	
				G950350	
				G950370	
				G950320	
				G950340	
				G950360	
<p><b>7</b></p> <p><b>Terminale aperto dx o sx per gola tipo "B" da utilizzare a fine composizione in presenza di fianco struttura non rifinito.</b>            RH or LH open end for type "B" finger rail to be placed at the end of the composition in presence of unfinished structure side.</p>  <p><b>terminale DX</b> RH end</p> <p><b>terminale SX</b> LH end</p>				<p><b>8</b></p> <p><b>Gola verticale intermedia tipo "D" (completa di distanziale)</b>            Type "D" intermediate vertical finger rail (complete with spacer)</p>  <p>sezione gola tipo "D" cross section of type "D" finger rail</p> <p>Piedi H 13 H 96 H 132 H 204 H 228</p> <p>Piedi H 6 H 108 H 144 H 216</p>	
	G950121			G950410	
	G950122			G950430	
				G950450	
				G950470	
				G950420	
				G950440	
				G950460	
<p><b>9</b></p> <p><b>Terminale chiuso dx o sx per gola tipo "B" da utilizzare solo tra cassettiere e lavastoviglie/colonne o a fine composizione in presenza di fianco struttura rifinito come anta senza scassi per gola.</b>            RH or LH closure for type "B" finger rail to be placed only between drawer units and dishwasher/columns or at the end of the composition in presence of structure side finished as a door without recess for finger rail.</p>  <p><b>terminale DX</b> RH end</p> <p><b>terminale SX</b> LH end</p>				<p><b>10</b></p> <p><b>Gola verticale laterale tipo "E" (completa di distanziale)</b>            Type "E" lateral vertical finger rail (complete with spacer)</p>  <p>sezione gola tipo "E" cross section of type "E" finger rail</p> <p>Piedi H 13 H 96 H 132 H 204 H 228</p> <p>Piedi H 6 H 108 H 144 H 216</p>	
	G950131			G950510	
	G950132			G950530	
				G950550	
				G950570	
				G950520	
				G950540	
				G950560	



**VISTA FRONTALE E LATERALE ZOCCOLO H 13 PER BASI H 88**

FRONT AND SIDE VIEW PLINTH H 13 FOR BASE UNITS H 88

**PROSPETTO LATERALE**

Fianco struttura come anta  
senza scasso per gola

**SIDE VIEW**

Structural side as door without  
recess for finger rail

**PROSPETTO LATERALE**

Fianco struttura con scassi per gola

**SIDE VIEW**

Structural side with recess for finger rail

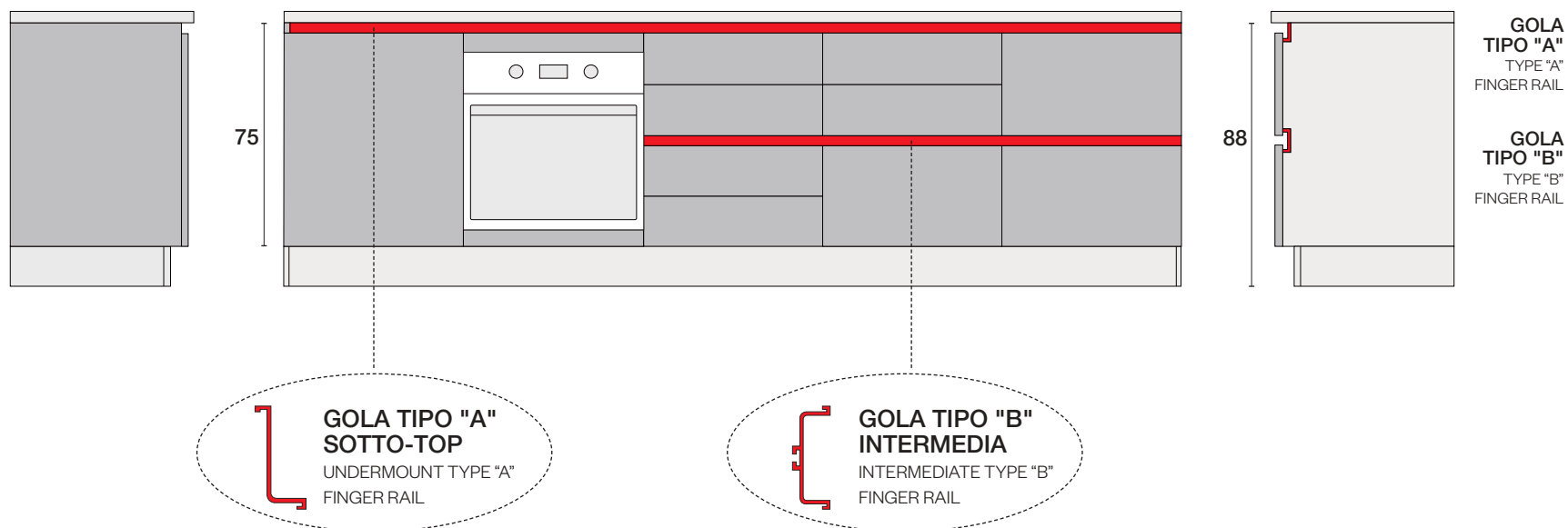

**VISTA FRONTALE E LATERALE ZOCCOLO H 6 PER BASI H 90**

FRONT AND SIDE VIEW PLINTH H 6 FOR BASE UNITS H 90

**PROSPETTO LATERALE**

Fianco struttura come anta  
senza scasso per gola

**SIDE VIEW**

Structural side as door without  
recess for finger rail

**PROSPETTO LATERALE**

Fianco struttura con scassi per gola

**SIDE VIEW**

Structural side with recess for finger rail

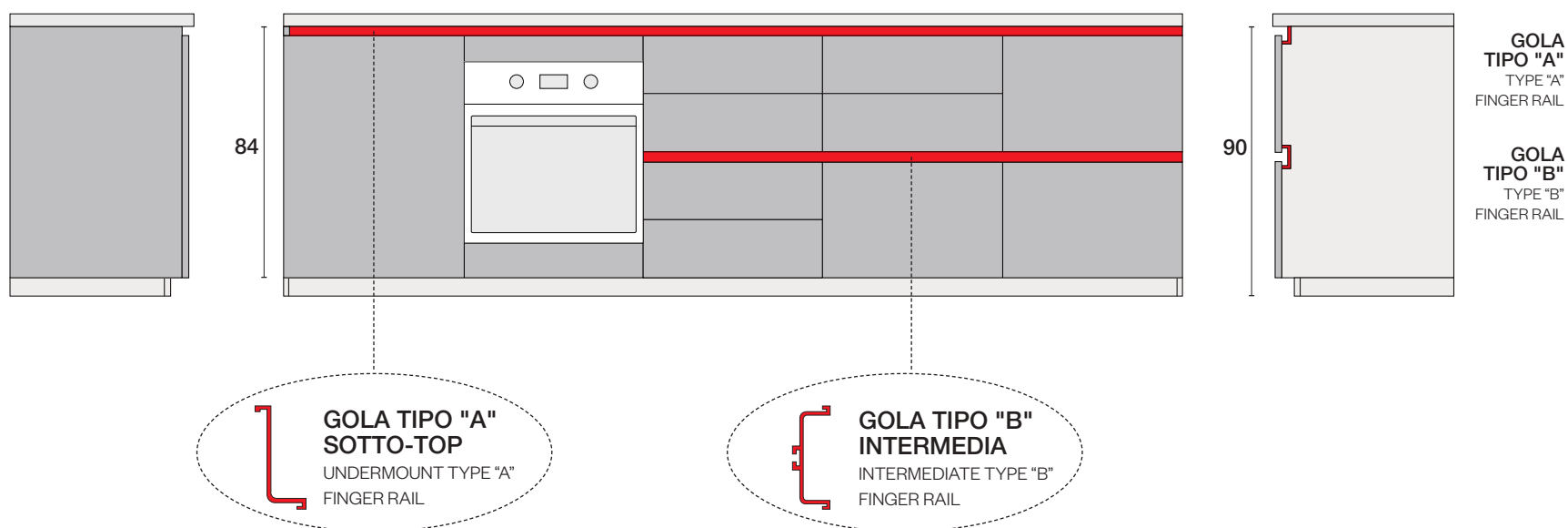



## VISTA FRONTALE ZOCCOLO H 13

FRONT VIEW PLINTH H 13

## VISTA FRONTALE ZOCCOLO H 6

FRONT VIEW PLINTH H 6

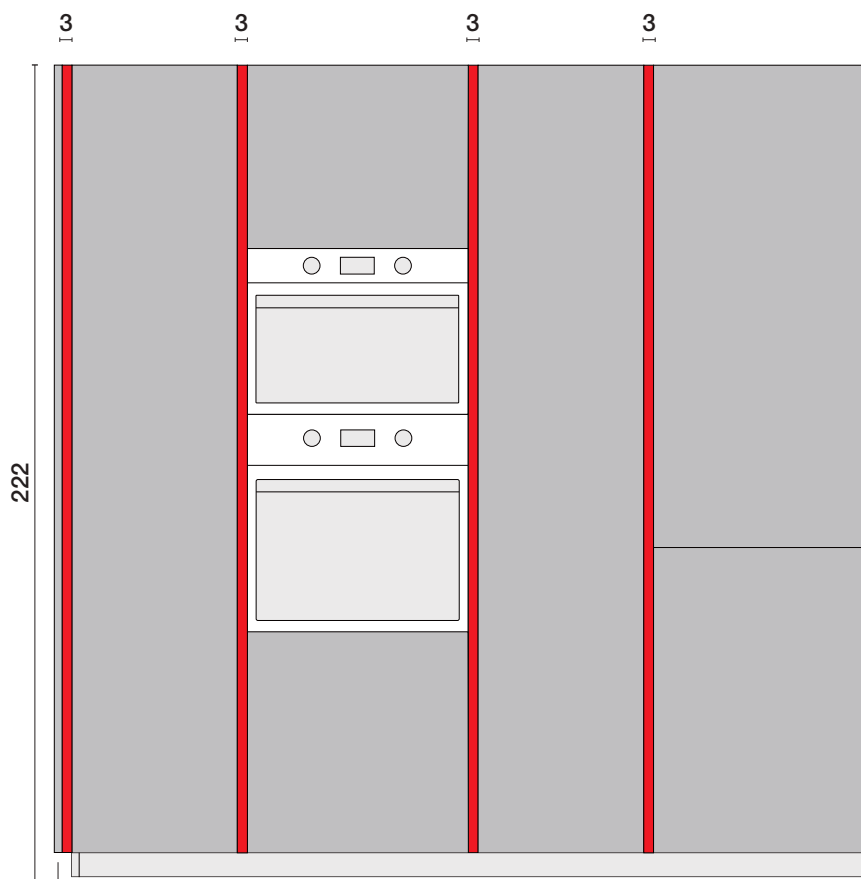
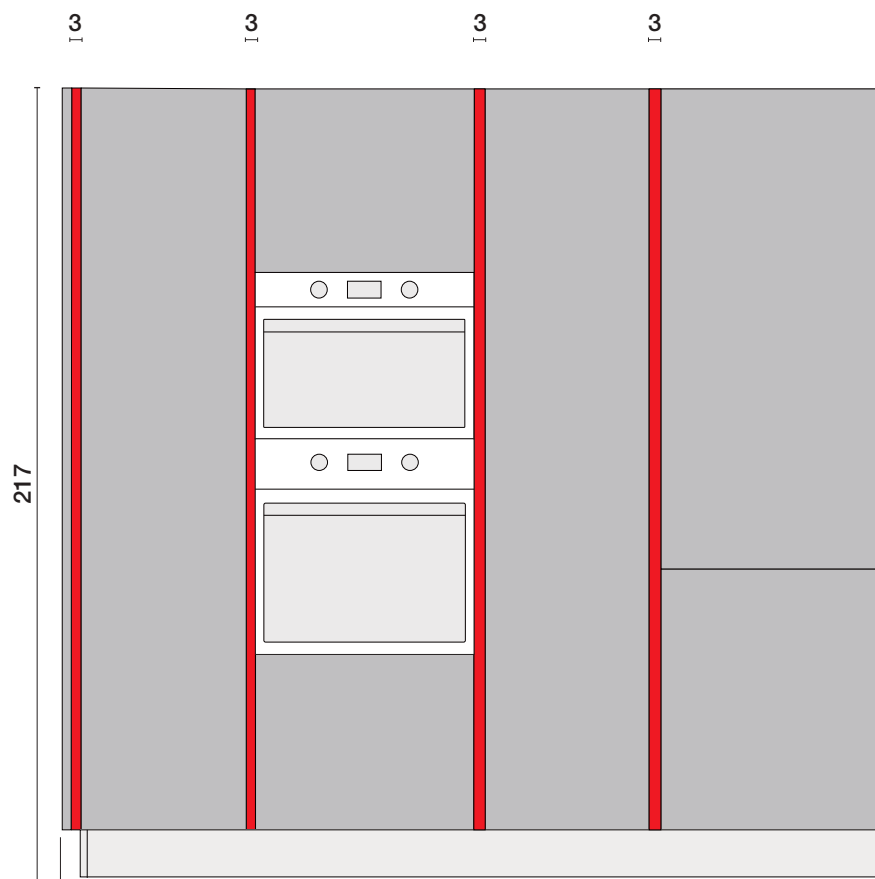

FIANCO RIPORTATO  
COME ANTA SP. 22 MM  
ADDITIONAL SIDE PANEL  
AS DOOR TH. 22 MM

**!** PER LA VERSIONE LUX SULLE COLONNE  
IL PROFILO ANTA È SEMPRE VERTICALE  
DOOR PROFILE ON THE COLUMNS FOR  
LUX VERSION IS ALWAYS VERTICAL

FIANCO RIPORTATO  
COME ANTA SP. 22 MM  
ADDITIONAL SIDE PANEL  
AS DOOR TH. 22 MM

**!** PER LA VERSIONE LUX SULLE COLONNE  
IL PROFILO ANTA È SEMPRE VERTICALE  
DOOR PROFILE ON THE COLUMNS FOR  
LUX VERSION IS ALWAYS VERTICAL

## VISTA DALL'ALTO

TOP VIEW

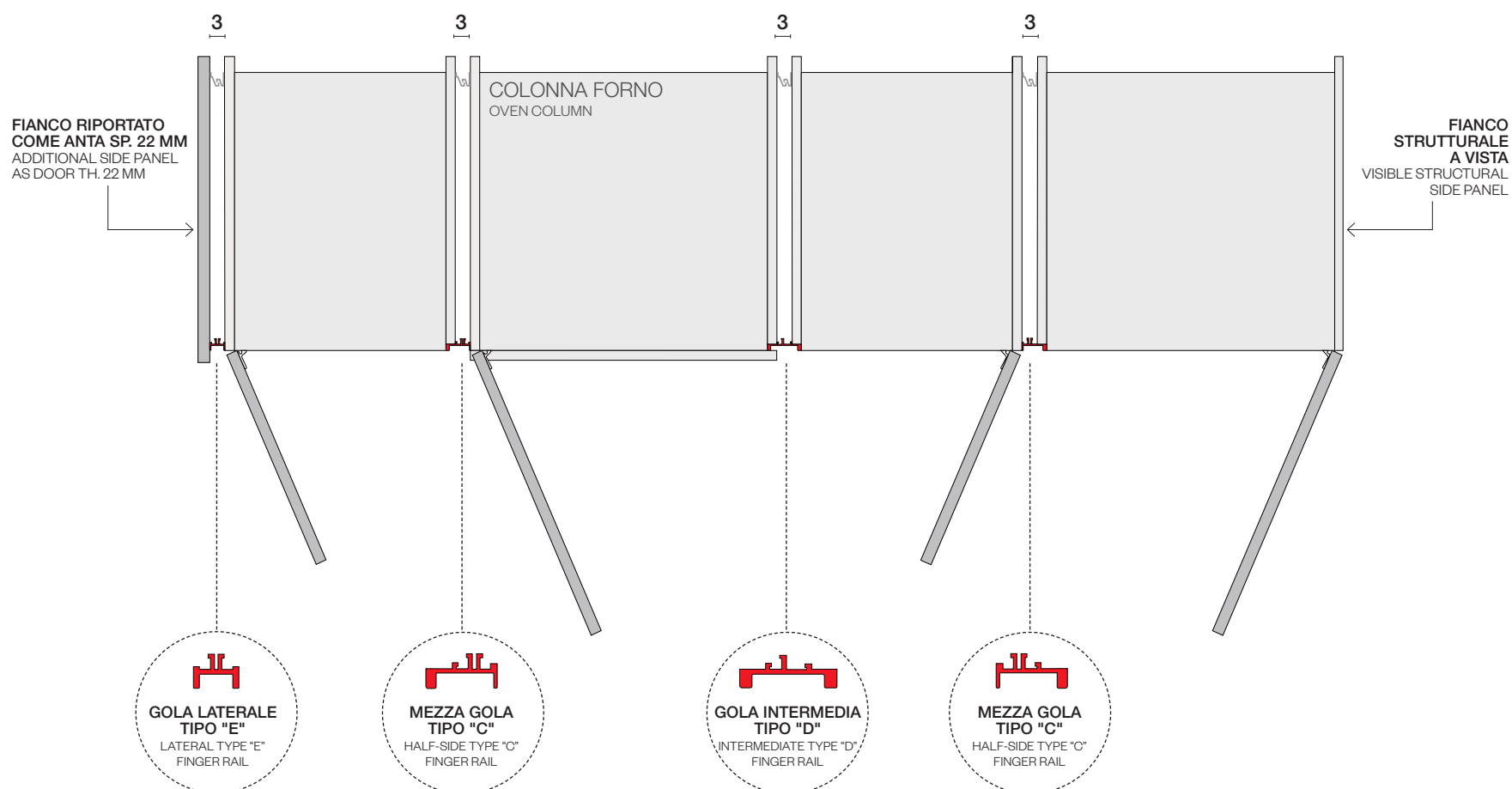



## DI SERIE STANDARD



Maniglia 350T finitura acciaio anodizzato  
Handle 350T anodized steel finish

Maniglia 350  
anta L 15 → passo 160 mm in verticale  
anta da L 30 a L 45 → passo 160 mm  
anta da L 60 a L 120 → passo 320 mm

Handle 350  
door W 15 → centre-to-centre distance 160 mm vertical  
door from W 30 to W 45 → centre-to-centre distance 160 mm  
door from W 60 to W 120 → centre-to-centre distance 320 mm

Maniglia 350N finitura nero  
Handle 350N black finish

## A RICHIESTA ON REQUEST



Maniglia 351R finitura rame brunito  
anta L 15 → passo 96 mm  
anta L 30 a L 45 → passo 160 mm  
anta da L 60 a L 120 → passo 320 mm

Handle 351R brushed copper finish  
door W 15 → centre-to-centre distance 96 mm  
door W 30 to W 45 → centre-to-centre distance 160 mm  
door from W 60 to W 120 → centre-to-centre distance 320 mm



Maniglia 351S finitura silver dark  
anta L 15 → passo 96 mm  
anta L 30 a L 45 → passo 160 mm  
anta da L 60 a L 120 → passo 320 mm

Handle 351S silver dark finish  
door W 15 → centre-to-centre distance 96 mm  
door W 30 to W 45 → centre-to-centre distance 160 mm  
door from W 60 to W 120 → centre-to-centre distance 320 mm



Maniglia M30N finitura nero opaco  
anta L 15 → passo 160 mm in verticale  
anta da L 30 a L 45 → passo 160 mm  
anta da L 60 a L 120 → passo 320 mm

Handle M30N matt black finish  
door W 15 → centre-to-centre distance 160 mm vertical  
door from W 30 to W 45 → centre-to-centre distance 160 mm  
door from W 60 to W 120 → centre-to-centre distance 320 mm



Maniglia 351T finitura titanio  
anta L 15 → passo 96 mm  
anta L 30 a L 45 → passo 160 mm  
anta da L 60 a L 120 → passo 320 mm

Handle 351T titanium finish  
door W 15 → centre-to-centre distance 96 mm  
door W 30 to W 45 → centre-to-centre distance 160 mm  
door from W 60 to W 120 → centre-to-centre distance 320 mm



Maniglia 351B finitura dark brown  
anta L 15 → passo 96 mm  
anta L 30 a L 45 → passo 160 mm  
anta da L 60 a L 120 → passo 320 mm

Handle 351B brown dark finish  
door W 15 → centre-to-centre distance 96 mm  
door W 30 to W 45 → centre-to-centre distance 160 mm  
door from W 60 to W 120 → centre-to-centre distance 320 mm



Maniglia 352G finitura oro  
anta L 15 → pomo  
anta L 30 a L 45 → passo 160 mm  
anta da L 60 a L 120 → passo 320 mm

Handle 352G gold finish  
door W 15 → knob  
door W 30 to W 45 → centre-to-centre distance 160 mm  
door from W 60 to W 120 → centre-to-centre distance 320 mm



Maniglia 567A finitura soft verniciata antracite  
anta L 15 → passo 64 mm  
anta da L 30 a L 45 → passo 160 mm  
anta da L 60 a L 120 → passo 320 mm

Handle 567A coated soft anthracite finish  
door W 15 → centre-to-centre distance 64 mm  
door from W 30 to W 45 → centre-to-centre distance 160 mm  
door from W 60 to W 120 → centre-to-centre distance 320 mm



Maniglia U6  
anta L 15 → passo 96 mm  
anta L 30 a L 45 → passo 160 mm  
anta da L 60 a L 120 → passo 320 mm

Handle U6  
door W 15 → centre-to-centre distance 96 mm  
door W 30 to W 45 → centre-to-centre distance 160 mm  
door from W 60 to W 120 → centre-to-centre distance 320 mm

Maniglia U6N finitura nero  
Handle U6N black finish

Maniglia U6K finitura nichel satinato  
Handle U6K satin nickel finish

**A RICHIESTA ON REQUEST**



Maniglia 592S finitura silver dark  
 anta L 15 → passo 64 mm  
 anta L 30 a L 45 → passo 160 mm  
 anta da L 60 a L 120 → passo 320 mm

Handle 592S dark silver finish  
 door W 15 → centre-to-centre distance 64 mm  
 door W 30 to W 45 → centre-to-centre distance 160 mm  
 door from W 60 to W 120 → centre-to-centre distance 320 mm



Maniglia 592B finitura bronzo brunito  
 anta L 15 → passo 64 mm  
 anta L 30 a L 45 → passo 160 mm  
 anta da L 60 a L 120 → passo 320 mm

Handle 592B burnished bronze finish  
 door W 15 → centre-to-centre distance 64 mm  
 door W 30 to W 45 → centre-to-centre distance 160 mm  
 door from W 60 to W 120 → centre-to-centre distance 320 mm



Maniglia M31K finitura satinato spazzolato  
 anta L 15 → passo 160 mm VERTICALE  
 anta L 30 a L 45 → passo 160 mm  
 anta da L 60 a L 120 → passo 320 mm

Handle M31K satin brushed finish  
 door W 15 → centre-to-centre distance 160 mm VERTICAL  
 door W 30 to W 45 → centre-to-centre distance 160 mm  
 door from W 60 to W 120 → centre-to-centre distance 320 mm



Maniglia 60S finitura silver dark  
 anta L 15 → passo 96 mm  
 anta L 30 a L 45 → passo 160 mm  
 anta da L 60 a L 120 → passo 320 mm

Handle 60S dark silver finish  
 door W 15 → centre-to-centre distance 96 mm  
 door W 30 to W 45 → centre-to-centre distance 160 mm  
 door from W 60 to W 120 → centre-to-centre distance 320 mm



Maniglia 60V finitura visone  
 anta L 15 → passo 96 mm  
 anta L 30 a L 45 → passo 160 mm  
 anta da L 60 a L 120 → passo 320 mm

Handle 60V mink finish  
 door W 15 → centre-to-centre distance 96 mm  
 door W 30 to W 45 → centre-to-centre distance 160 mm  
 door from W 60 to W 120 → centre-to-centre distance 320 mm



Maniglia M32T finitura titanio  
 anta L 15 → passo 160 mm VERTICALE  
 anta L 30 a L 45 → passo 160 mm  
 anta da L 60 a L 120 → passo 320 mm

Handle M32T titanium finish  
 door W 15 → centre-to-centre distance 160 mm VERTICAL  
 door W 30 to W 45 → centre-to-centre distance 160 mm  
 door from W 60 to W 120 → centre-to-centre distance 320 mm



Maniglia 59S finitura anodizzato silver dark  
 anta L 15 → passo 32 mm  
 anta L 30 a L 45 → passo 160 mm  
 anta da L 60 a L 120 → passo 448 mm

Handle 59S oxidized dark silver finish  
 door W 15 → centre-to-centre distance 32 mm  
 door W 30 to W 45 → centre-to-centre distance 160 mm  
 door from W 60 to W 120 → centre-to-centre distance 448 mm



Maniglia 59RA finitura anodizzato rame anticato  
 anta L 15 → passo 32 mm  
 anta L 30 a L 45 → passo 160 mm  
 anta da L 60 a L 120 → passo 448 mm

Handle 59RA oxidized antiqued copper finish  
 door W 15 → centre-to-centre distance 32 mm  
 door W 30 to W 45 → centre-to-centre distance 160 mm  
 door from W 60 to W 120 → centre-to-centre distance 448 mm



Maniglia 59BA finitura anodizzato bronzo anticato  
 anta L 15 → passo 32 mm  
 anta L 30 a L 45 → passo 160 mm  
 anta da L 60 a L 120 → passo 448 mm

Handle 59BA oxidized antiqued bronze finish  
 door W 15 → centre-to-centre distance 32 mm  
 door W 30 to W 45 → centre-to-centre distance 160 mm  
 door from W 60 to W 120 → centre-to-centre distance 448 mm



Maniglia 59BB finitura anodizzato titanio  
 anta L 15 → passo 32 mm  
 anta L 30 a L 45 → passo 160 mm  
 anta da L 60 a L 120 → passo 448 mm

Handle 59BB oxidized titanium finish  
 door W 15 → centre-to-centre distance 32 mm  
 door W 30 to W 45 → centre-to-centre distance 160 mm  
 door from W 60 to W 120 → centre-to-centre distance 448 mm



Maniglia 59N finitura anodizzato nero  
 anta L 15 → passo 32 mm  
 anta L 30 a L 45 → passo 160 mm  
 anta da L 60 a L 120 → passo 448 mm

Handle 59N oxidized black finish  
 door W 15 → centre-to-centre distance 32 mm  
 door W 30 to W 45 → centre-to-centre distance 160 mm  
 door from W 60 to W 120 → centre-to-centre distance 448 mm



Maniglia 59G finitura ghisa  
 anta L 15 → passo 32 mm  
 anta L 30 a L 45 → passo 160 mm  
 anta da L 60 a L 120 → passo 448 mm

Handle 59G cast iron finish  
 door W 15 → centre-to-centre distance 32 mm  
 door W 30 to W 45 → centre-to-centre distance 160 mm  
 door from W 60 to W 120 → centre-to-centre distance 448 mm

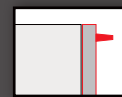

## MANIGLIA VERTICALE VERTICAL HANDLE



Maniglia M30NV finitura nero opaco  
passo in funzione dell'anta, vedi disegno tecnico  
Handle M30NV matt black finish  
centre-to-centre distance varies according to the door, see technical drawing

 La maniglia verticale non è disponibile per tutti gli elementi. Non inseribile su pensili, basi ed elementi fuori misura  
The vertical handle is not compatible with all the elements. Is not possible to insert it on the wall units, base units and oversized elements

MANIGLIA HANDLE	L. 39,7	passo 383 mm
MANIGLIA HANDLE	L. 51,7	passo 503 mm
MANIGLIA HANDLE	L. 63,7	passo 623 mm
MANIGLIA HANDLE	L. 75,7	passo 743 mm
MANIGLIA HANDLE	L. 123,7	passo 623/600 mm
MANIGLIA HANDLE	L. 135,7	passo 743/600 mm
MANIGLIA HANDLE	L. 195,7	passo 623/697/623 mm
MANIGLIA HANDLE	L. 207,7	passo 623/697/743 mm

# DISEGNO TECNICO MANIGLIA HANDLE TECHNICAL DRAWING

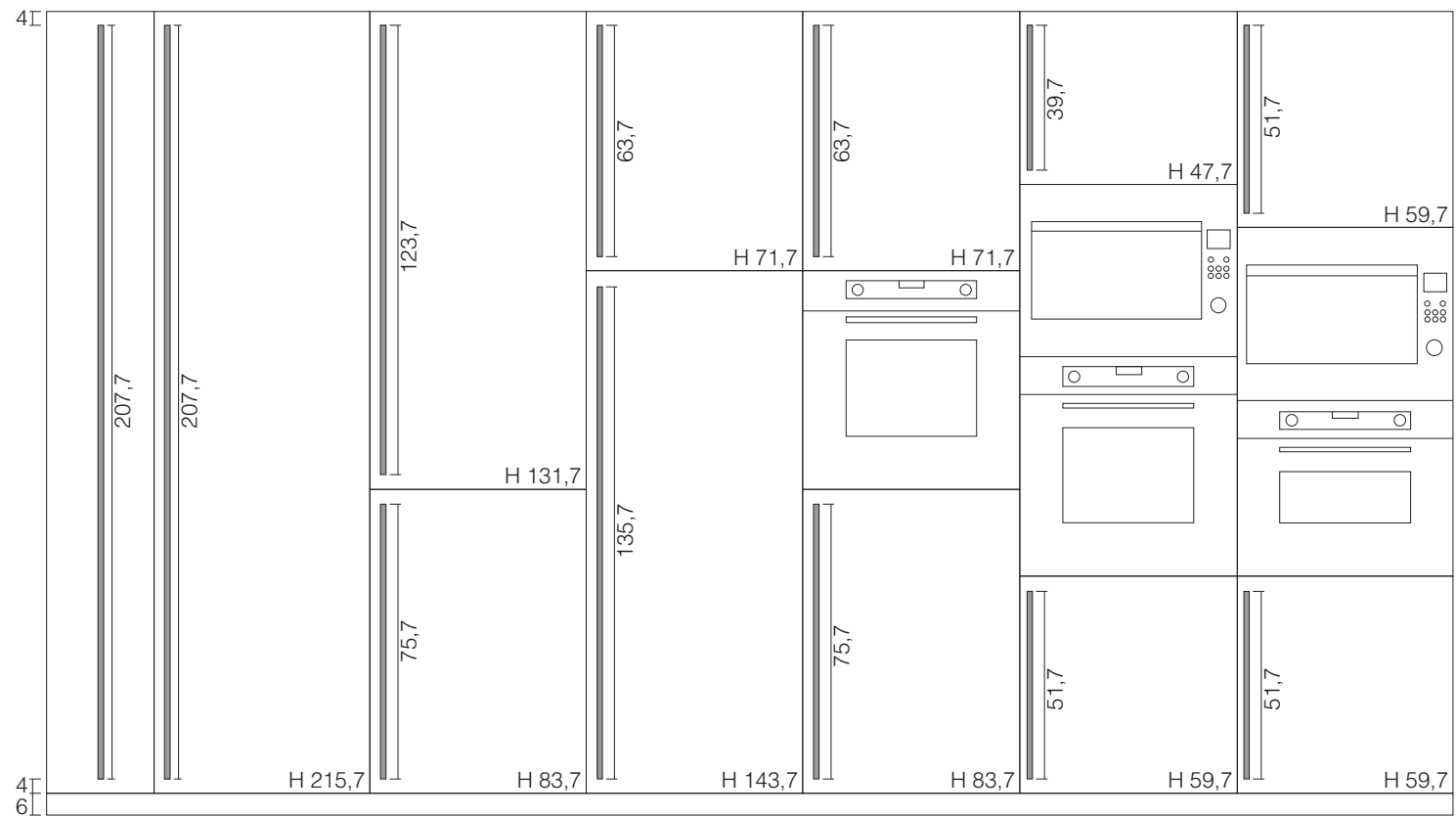
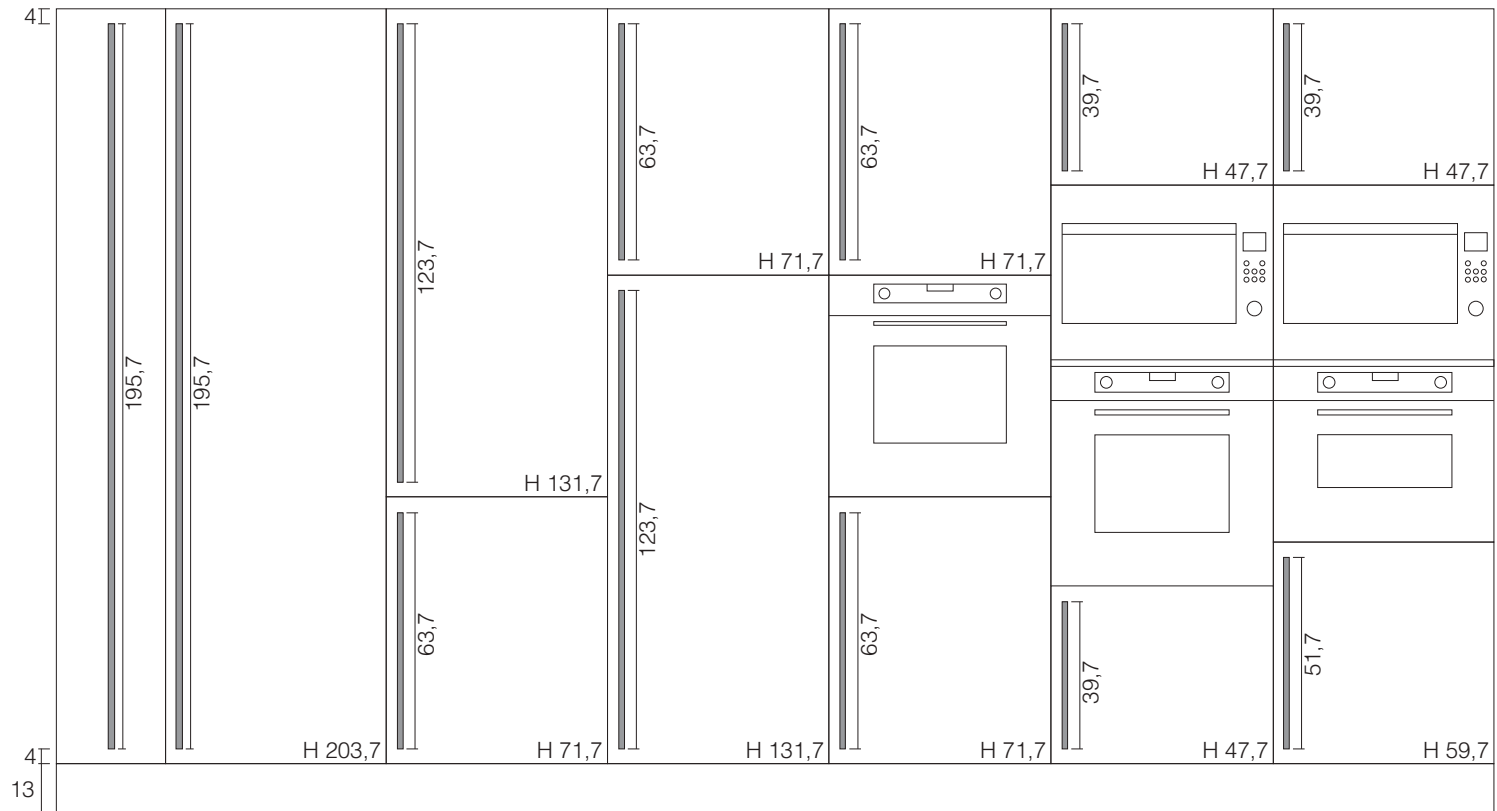

 La maniglia verticale è disponibile anche per colonne con anta fino a terra, mantenendo lo stesso allineamento dall'alto riportato nei disegni tecnici.  
The vertical handle is also available for columns with door down the ground while maintaining the same alignment from above shown in the technical drawings.

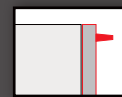

## MANIGLIA VERTICALE VERTICAL HANDLE



MANIGLIA HANDLE	L. 41,7	passo 383 mm
MANIGLIA HANDLE	L. 53,7	passo 503 mm
MANIGLIA HANDLE	L. 65,7	passo 623 mm
MANIGLIA HANDLE	L. 77,7	passo 743 mm
MANIGLIA HANDLE	L. 125,7	passo 623/600 mm
MANIGLIA HANDLE	L. 137,7	passo 743/600 mm
MANIGLIA HANDLE	L. 197,7	passo 623/697/623 mm
MANIGLIA HANDLE	L. 209,7	passo 623/697/743 mm

Maniglia M31KV finitura satinato spazzolato  
passo in funzione dell'anta, vedi disegno tecnico  
Handle M31KV satin brushed finish  
centre-to-centre distance varies according to the door, see technical drawing



MANIGLIA HANDLE	L. 41,7	passo 383 mm
MANIGLIA HANDLE	L. 53,7	passo 503 mm
MANIGLIA HANDLE	L. 65,7	passo 623 mm
MANIGLIA HANDLE	L. 77,7	passo 743 mm
MANIGLIA HANDLE	L. 125,7	passo 623/600 mm
MANIGLIA HANDLE	L. 137,7	passo 743/600 mm
MANIGLIA HANDLE	L. 197,7	passo 623/697/623 mm
MANIGLIA HANDLE	L. 209,7	passo 623/697/743 mm

Maniglia M32TV finitura titanio  
passo in funzione dell'anta, vedi disegno tecnico  
Handle M32TV titanium finish  
centre-to-centre distance varies according to the door, see technical drawing

 La maniglia verticale non è disponibile per tutti gli elementi. Non inseribile su pensili, basi ed elementi fuori misura.  
The vertical handle is not compatible with all the elements. Is not possible to insert it on the wall units, base units and oversized elements



# DISEGNO TECNICO MANIGLIE HANDLES TECHNICAL DRAWING

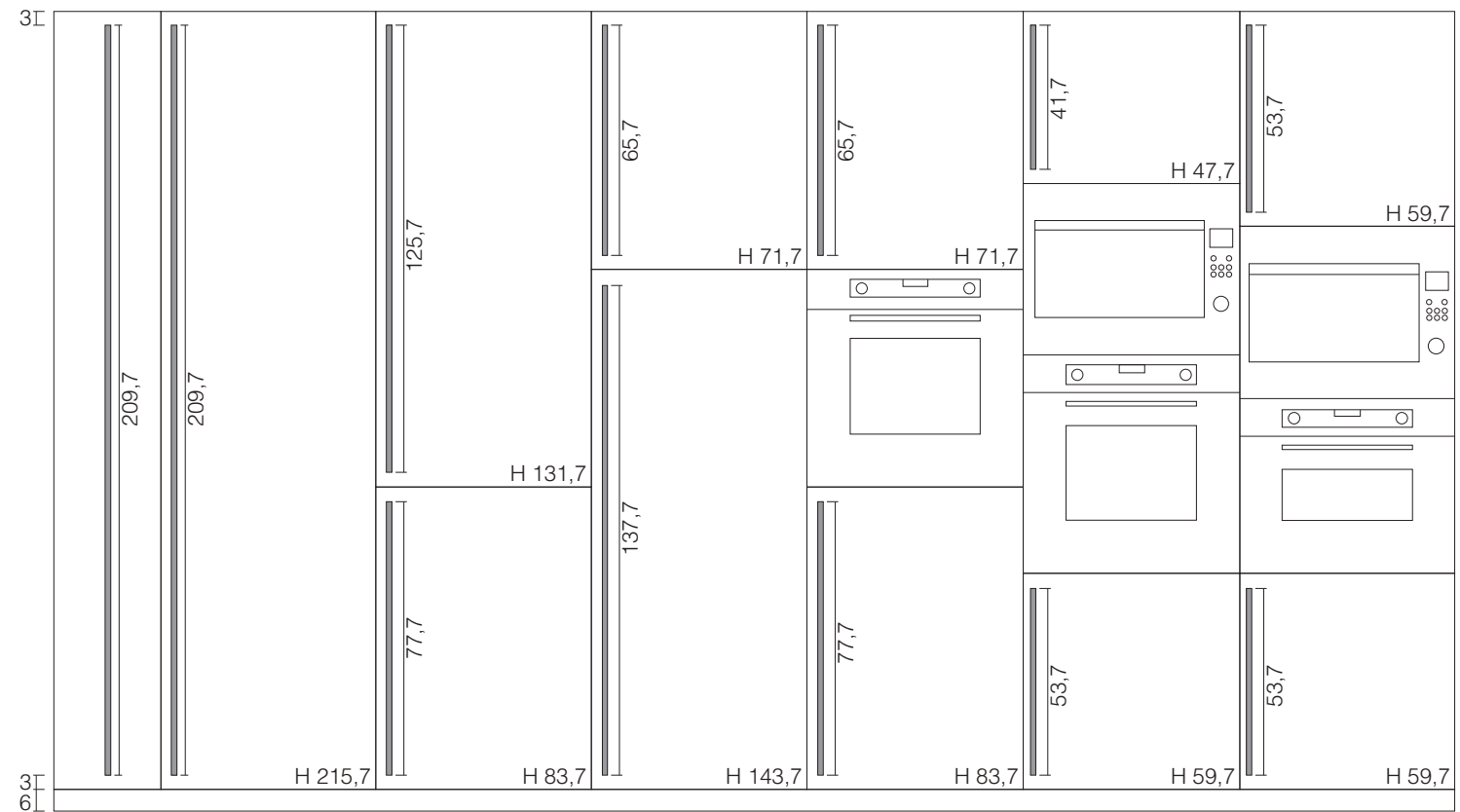
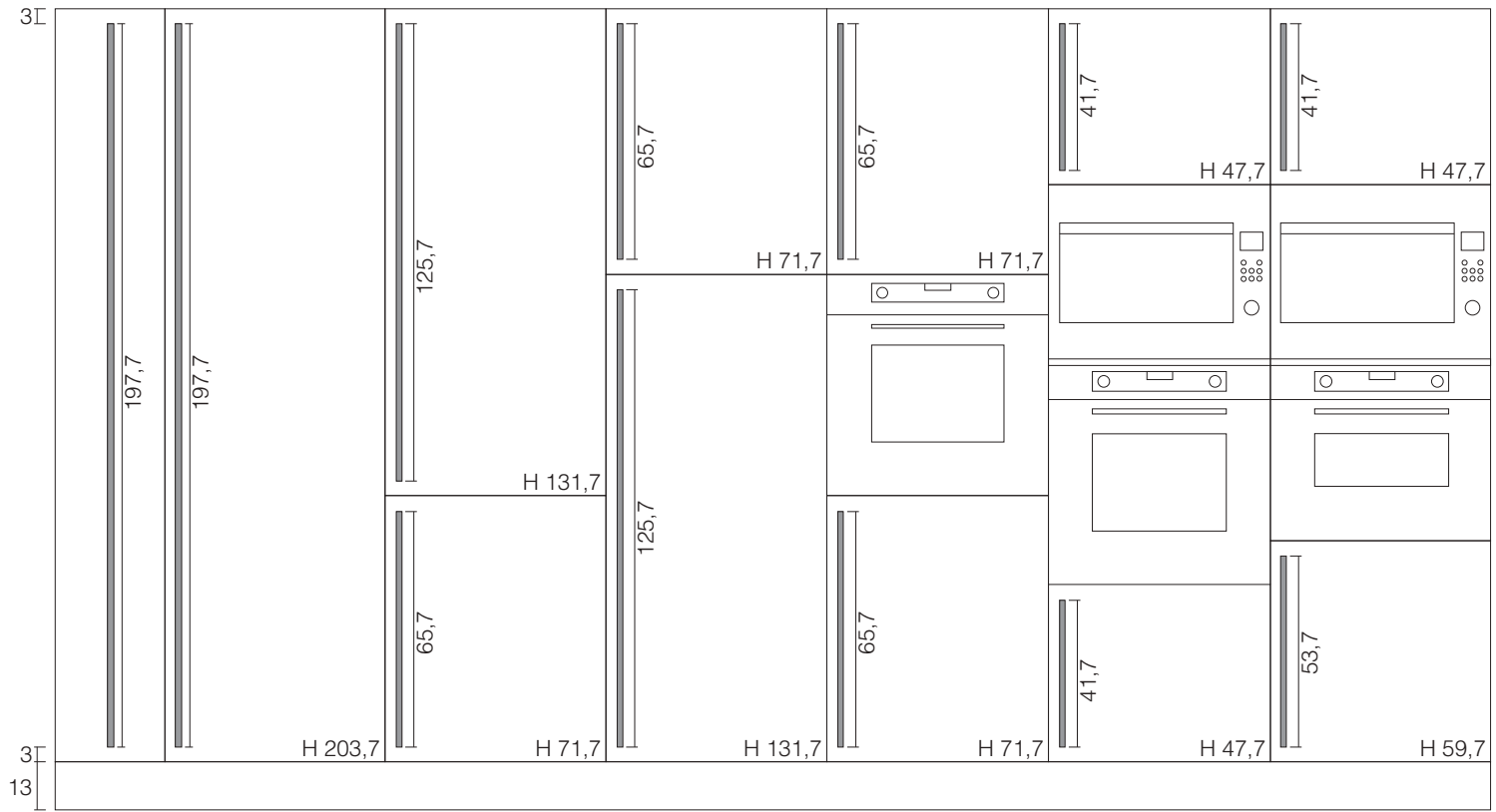

 La maniglia verticale è disponibile anche per colonne con anta fino a terra, mantenendo lo stesso allineamento dall'alto riportato nei disegni tecnici.  
The vertical handle is also available for columns with door down the ground while maintaining the same alignment from above shown in the technical drawings.

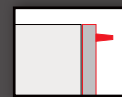

## A RICHIESTA ON REQUEST



Maniglia 948S finitura silver dark  
 anta L 15 → passo 64 mm  
 anta da L 30 a L 45 → passo 160 mm  
 anta da L 60 a L 120 → passo 320 mm

Handle 948S dark silver finish  
 door W 15 → centre-to-centre distance 64 mm  
 door from W 30 to W 45 → centre-to-centre distance 160 mm  
 door from W 60 to W 120 → centre-to-centre distance 320 mm



Maniglia 948G finitura ghisa  
 anta L 15 → passo 64 mm  
 anta da L 30 a L 45 → passo 160 mm  
 anta da L 60 a L 120 → passo 320 mm

Handle 948G cast iron finish  
 door W 15 → centre-to-centre distance 64 mm  
 door from W 30 to W 45 → centre-to-centre distance 160 mm  
 door from W 60 to W 120 → centre-to-centre distance 320 mm



Maniglia 948T finitura titanio  
 anta L 15 → passo 64 mm  
 anta da L 30 a L 45 → passo 160 mm  
 anta da L 60 a L 120 → passo 320 mm

Handle 948T titanium finish  
 door W 15 → centre-to-centre distance 64 mm  
 door from W 30 to W 45 → centre-to-centre distance 160 mm  
 door from W 60 to W 120 → centre-to-centre distance 320 mm

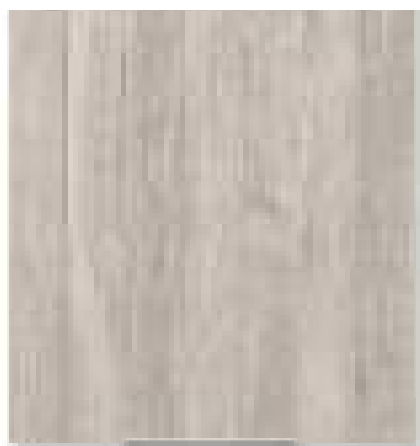

Anta Pensile  
Wall unit door



Anta Base  
Base unit door



Anta Colonna  
Column door

### Angolo pensile a libro Corner wall unit folding

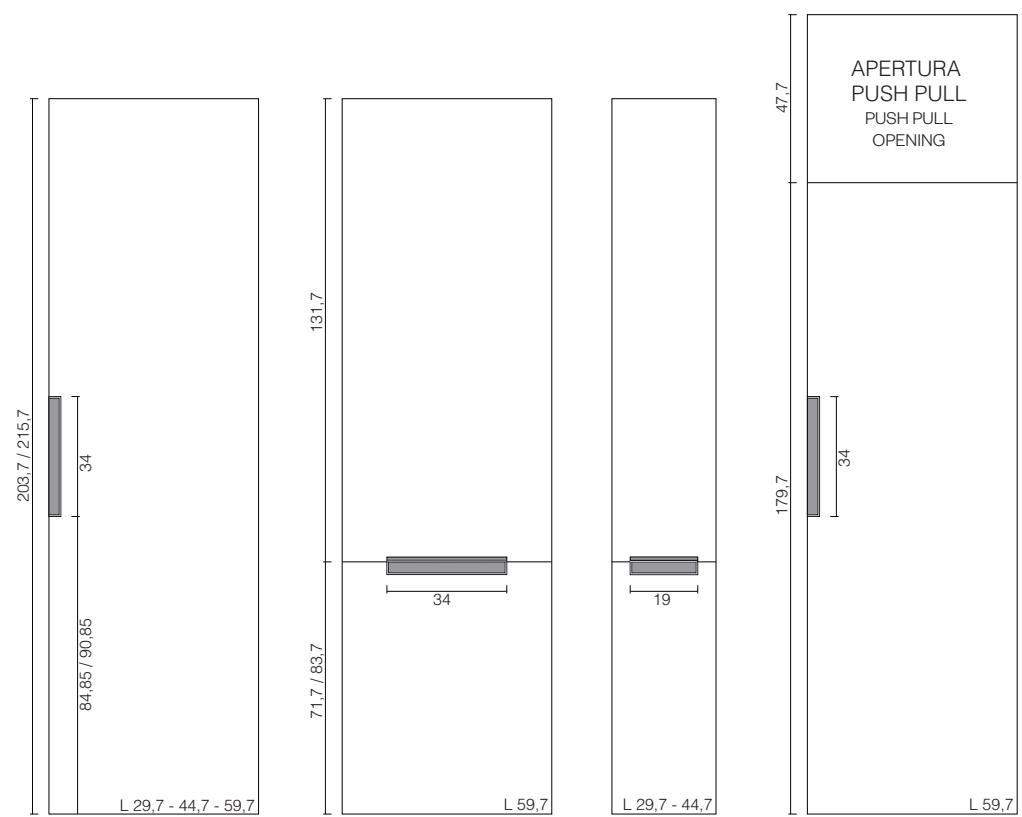
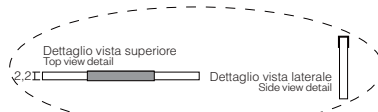
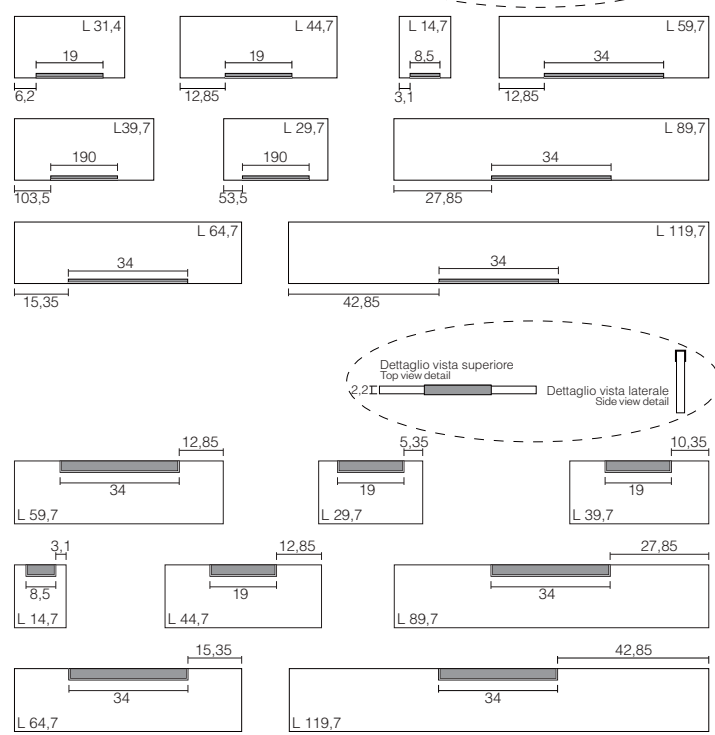

**A RICHIESTA** ON REQUEST



Maniglia 940T finitura titanio  
Handle 940T titanium finish



Maniglia 940Z finitura azzurro nube  
Handle 940Z cloud blue finish

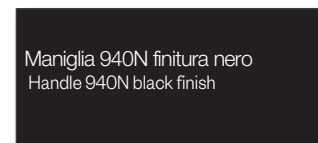

Maniglia 940N finitura nero  
Handle 940N black finish

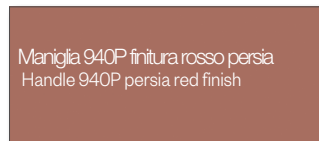

Maniglia 940P finitura rosso persia  
Handle 940P persia red finish



Maniglia 940S finitura silver dark  
Handle 940S dark silver finish

Maniglia 940 ad incasso  
dimensioni mm L 182 H 47

Built-in handle 940  
dimensions W 182 H 47 mm



Maniglia 947G ad incasso finitura verniciato ghisa  
anta L 15 → dimensioni L 85 mm  
anta da L 30 a L 45 → dimensioni L 190 mm  
anta da L 60 a L 120 → dimensioni L 340 mm  
anta da H 203,7 a H 215,7 → dimensioni L 676 mm

Handle 947G recessed cast iron painted finish  
door W 15 → dimensions W 85 mm  
door from W 30 to W 45 → dimensions W 190 mm  
door from W 60 to W 120 → dimensions W 340 mm  
door from H 203,7 to H 215,7 → dimensions W 676 mm



Maniglia 947S ad incasso finitura silver dark  
anta L 15 → dimensioni L 85 mm  
anta da L 30 a L 45 → dimensioni L 190 mm  
anta da L 60 a L 120 → dimensioni L 340 mm  
anta da H 203,7 a H 215,7 → dimensioni L 676 mm

Handle 947S recessed dark silver finish  
door W 15 → dimensions W 85 mm  
door from W 30 to W 45 → dimensions W 190 mm  
door from W 60 to W 120 → dimensions W 340 mm  
door from H 203,7 to H 215,7 → dimensions W 676 mm



Maniglia 947T ad incasso finitura titanio  
anta L 15 → dimensioni L 85 mm  
anta da L 30 a L 45 → dimensioni L 190 mm  
anta da L 60 a L 120 → dimensioni L 340 mm  
anta da H 203,7 a H 215,7 → dimensioni L 676 mm

Handle 947T recessed titanium finish  
door W 15 → dimensions W 85 mm  
door from W 30 to W 45 → dimensions W 190 mm  
door from W 60 to W 120 → dimensions W 340 mm  
door from H 203,7 to H 215,7 → dimensions W 676 mm

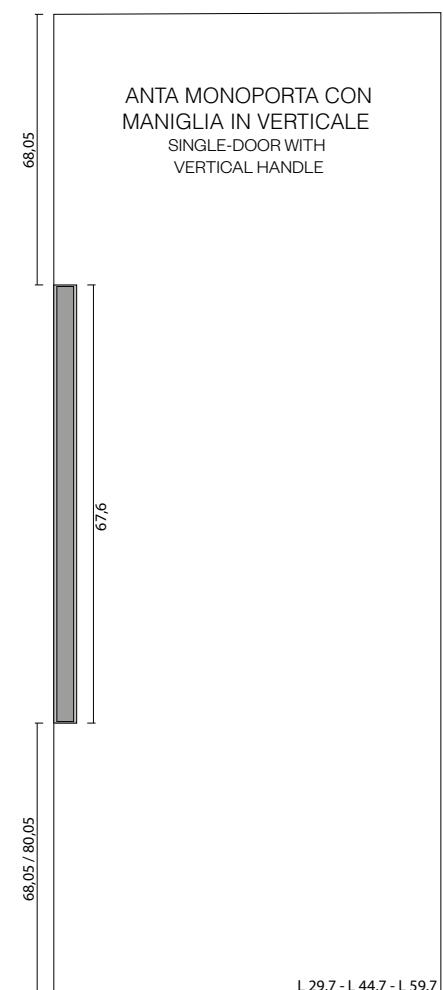
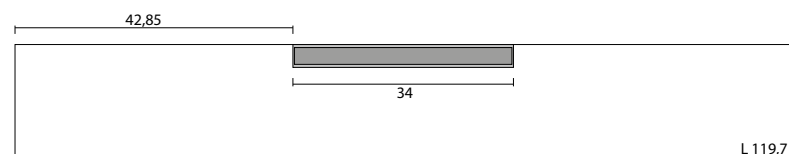
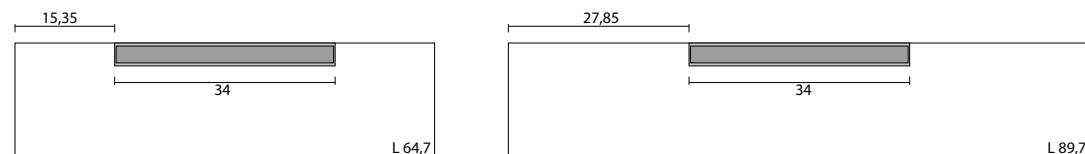
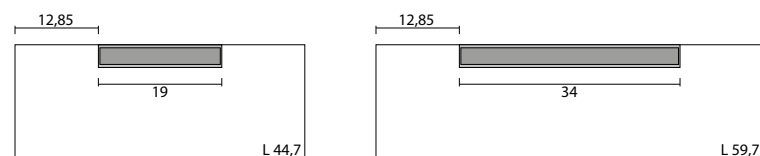
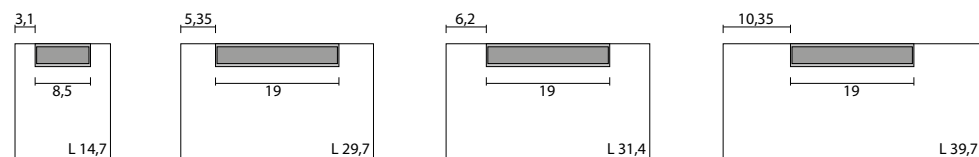

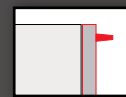

## MANIGLIA FUSION FUSION HANDLE



Maniglia fusion FU11  
finitura nero opaco  
passo in funzione dell'anta  
vedi disegno tecnico  
Handle fusion FU11 matt black finish  
centre-to-centre distance varies according  
to the door size see technical drawing



particolare maniglia fusion nero opaco  
detail black fusion matt black handle

MANIGLIA HANDLE	passo 357 mm
MANIGLIA HANDLE	passo 597 mm
MANIGLIA HANDLE	passo 717 mm
MANIGLIA HANDLE	passo 957 mm
MANIGLIA HANDLE	passo 1317 mm
MANIGLIA HANDLE	passo 1677 mm



Maniglia fusion FU12  
finitura titanio  
passo in funzione dell'anta  
vedi disegno tecnico  
Handle fusion FU12 titanium finish  
centre-to-centre distance varies according  
to the door size see technical drawing



particolare maniglia fusion titanio  
detail titaniu

 Maniglia inseribile solo per le finiture melaminiche e mathera con modulistica zoccolo H 13 e zoccolo H 6  
Handle allowed only for melamine and mathera finishes with forms plinth H13 and H6

# DISEGNO TECNICO MANIGLIA

## HANDLE TECHNICAL DRAWING

BASI H 85 (zoccolo H.13) / H.90 (zoccolo H.6)  
 BASE UNITS H 85 (plinth H.13) / H. 90 (plinth H.6)

BASE  
 BASE UNIT

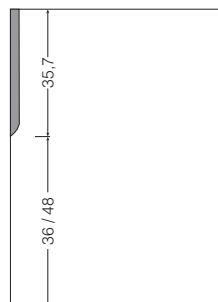

ANTA LAVASTOVIGLIE  
 CON SERVO-DRIVE FLEX  
 DISHWASHER DOOR  
 WITH SERVO-DRIVE FLEX

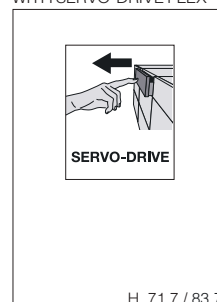

COLONNE H 109 - 145 (zoccolo H.13) / H 114 - 150 (zoccolo H.6)  
 COLUMNS H 109 - 145 (plinth H.13) / H 114 - 150 (plinth H.6)

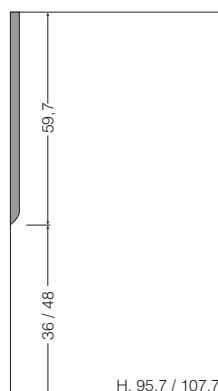

H. 95,7 / 107,7

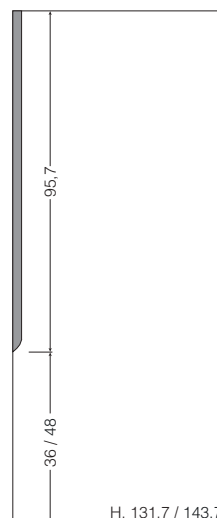

H. 131,7 / 143,7

COLONNE H 217 (zoccolo H. 13) / H 222 (zoccolo H.6)  
 COLUMNS H 217 (plinth H.13) / H 222 (plinth H.6)

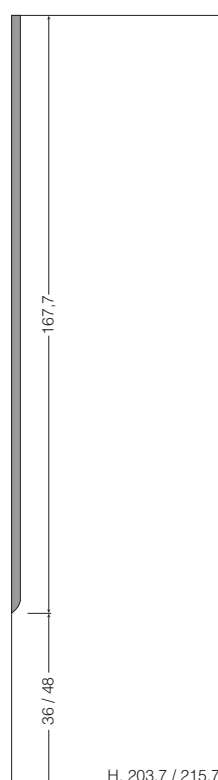

H. 203,7 / 215,7

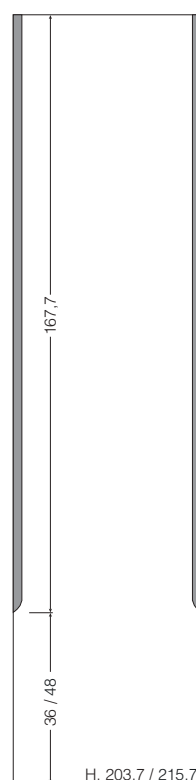

H. 203,7 / 215,7

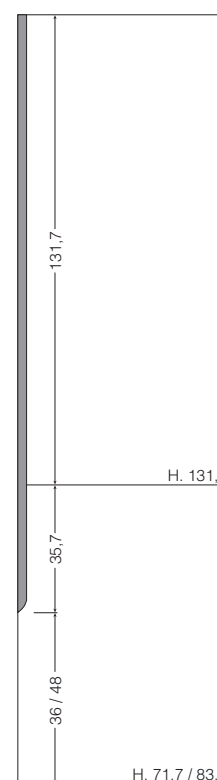

H. 71,7 / 83,7

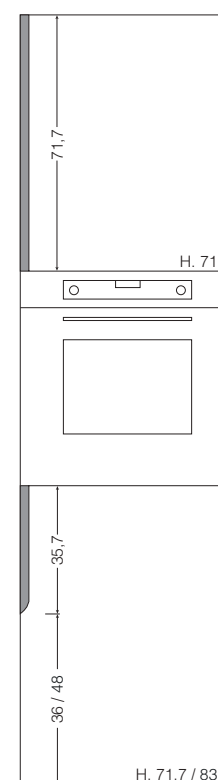

H. 71,7 / 83,7

 Non inseribile su pensili, basi cassette e cestoni  
 Not inserted on wall units, base units drawers and deep drawers

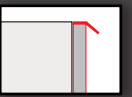

Maniglia H53 finitura silver dark  
vedi disegno tecnico

Handle H53 dark silver finish  
size see technical drawing



Maniglia H52 finitura titanio  
vedi disegno tecnico

Handle H52 titanium finish  
size see technical drawing



In presenza di questa maniglia non si possono tassativamente realizzare fuori misura in larghezza.  
Note: Custom-sized length elements cannot be realized using this handle.

# DISEGNO TECNICO MANIGLIA HANDLE TECHNICAL DRAWING

MANIGLIA APPLICATA IN TESTA  
TOP-MOUNTED HANDLE



MANIGLIA FRONTALE PER ANTA COLONNA  
FRONT DOOR HANDLE FOR COLUMN

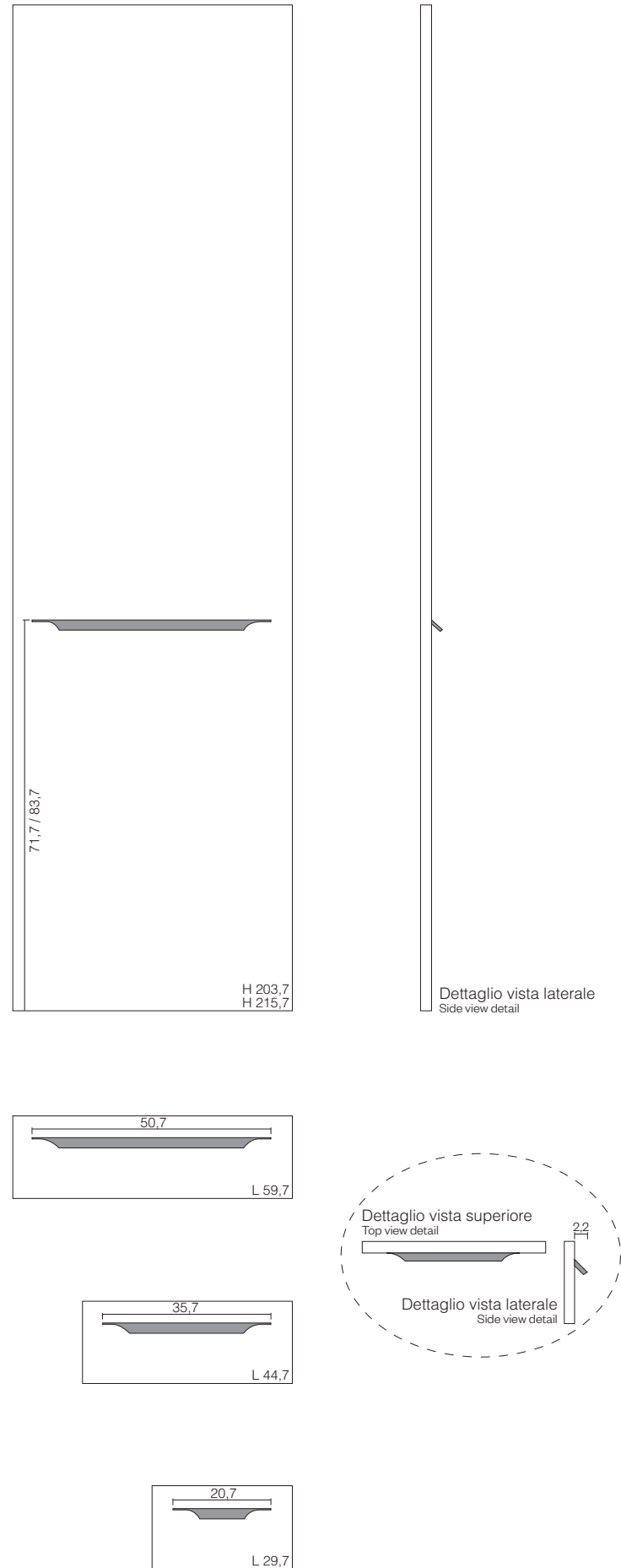

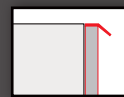

Maniglia H63 finitura silver dark  
vedi disegno tecnico

Handle H63 dark silver finish  
size see technical drawing



Maniglia H62 finitura titanio  
vedi disegno tecnico

Handle H62 titanium finish  
size see technical drawing

 In presenza di questa maniglia non si possono tassativamente realizzare fuori misura in larghezza.  
Note: Custom-sized length elements cannot be realized using this handle.





# DISEGNO TECNICO MANIGLIA HANDLE TECHNICAL DRAWING

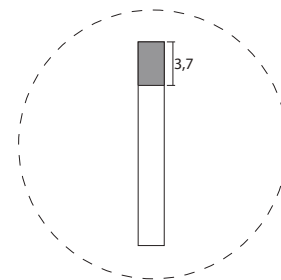
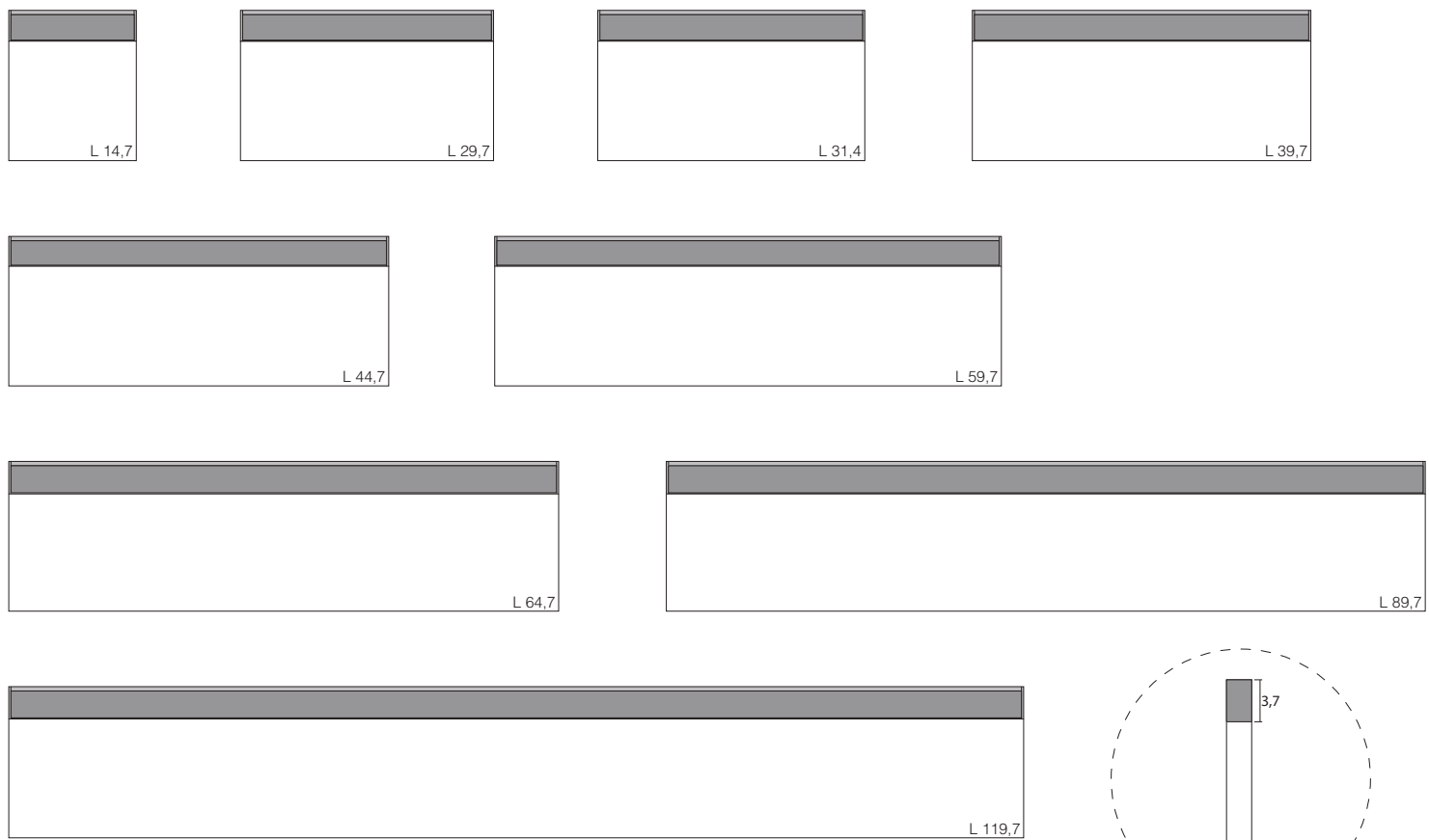

Dettaglio vista laterale  
Side view detail

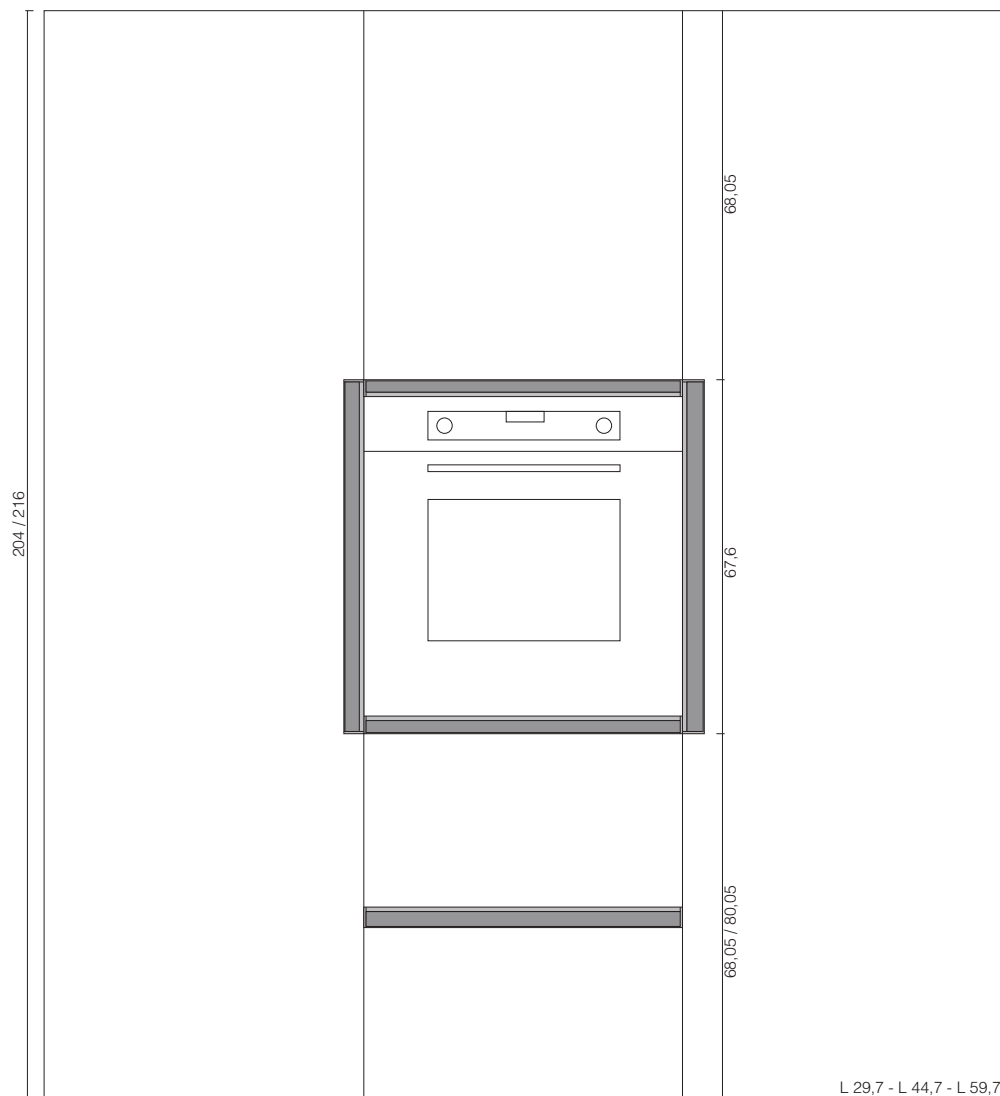

ANTA MONOPORTA CON  
MANIGLIA IN VERTICALE  
SINGLE DOOR  
WITH VERTICAL HANDLE

Dettaglio vista laterale  
Side view detail

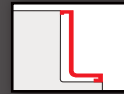

### PENSILI WALL UNITS

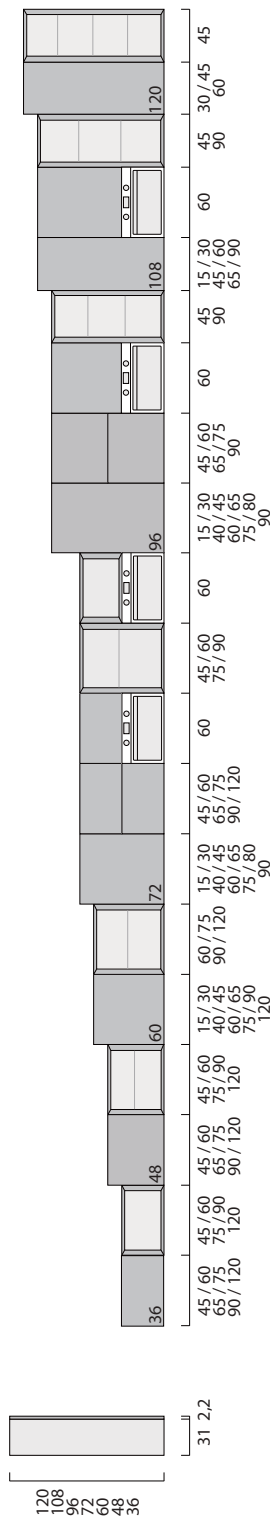

### BASI ZOCCOLO H.13

H.13 PLINTH BASE UNITS

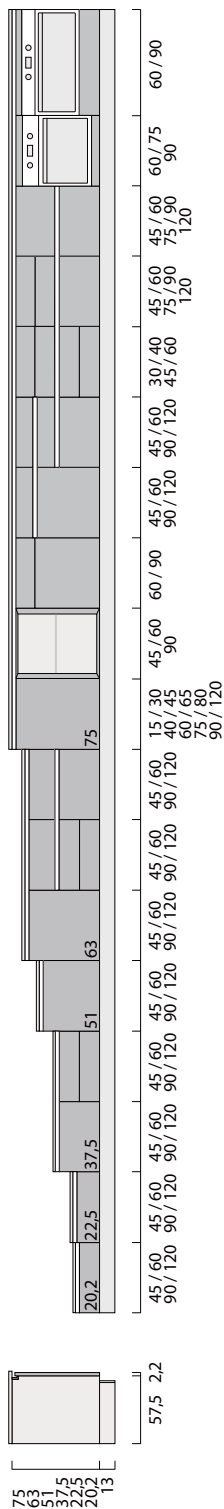

### BASI SOSPESE

SUSPENDED BASE UNITS

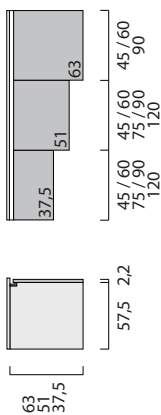

### BASI ZOCCOLO H.6

H.6 PLINTH BASE UNITS

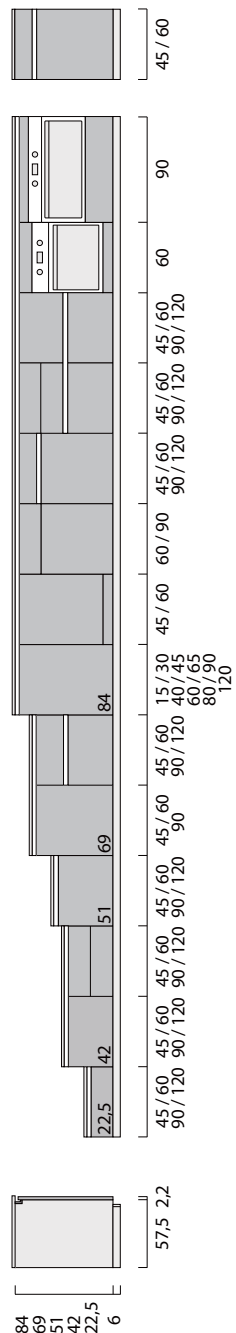

### BASI SOSPESE

SUSPENDED BASE UNITS

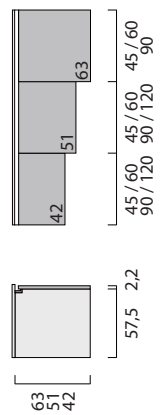

## COLONNE ZOCCOLO H.13 H.13 PLINTH COLUMNS

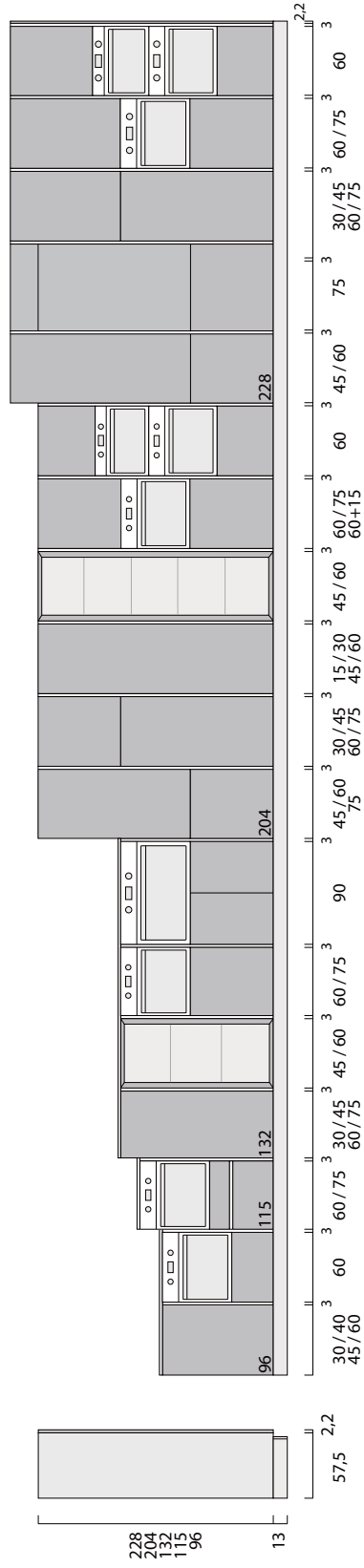

## COLONNE ZOCCOLO H.6 H.6 PLINTH COLUMNS

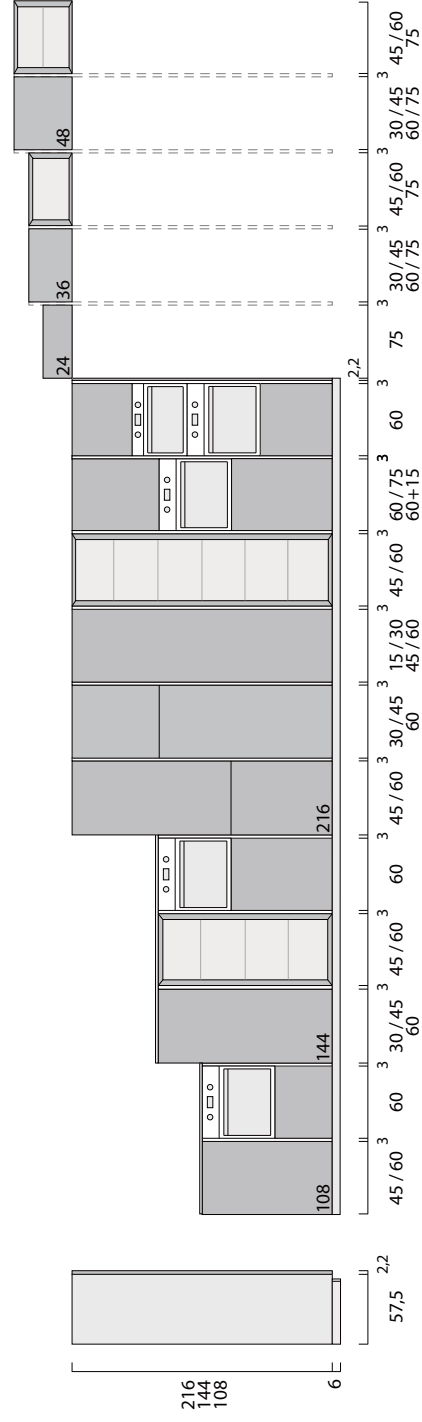

Elementi sopra colonna validi anche su colonne zoccolo H.13  
Above-column elements also valid on H.13 plinth columns



## ELEMENTI PER LIVING LIVING ELEMENTS

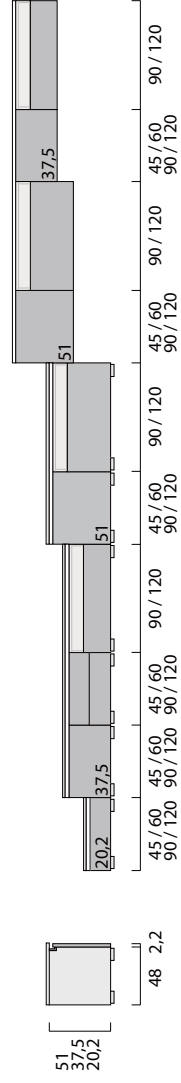

Per attrezzature interne e meccanismi di apertura vedere relative sezioni nel listino.  
For internal equipment and opening mechanisms, see respective sections in the price list.



Per dimensioni dei singoli frontali vedere relative sezioni nel listino.  
For size of individual doors, see respective sections in the price list.





## COLONNE ZOCCOLO H.13

### H.13 PLINTH COLUMNS

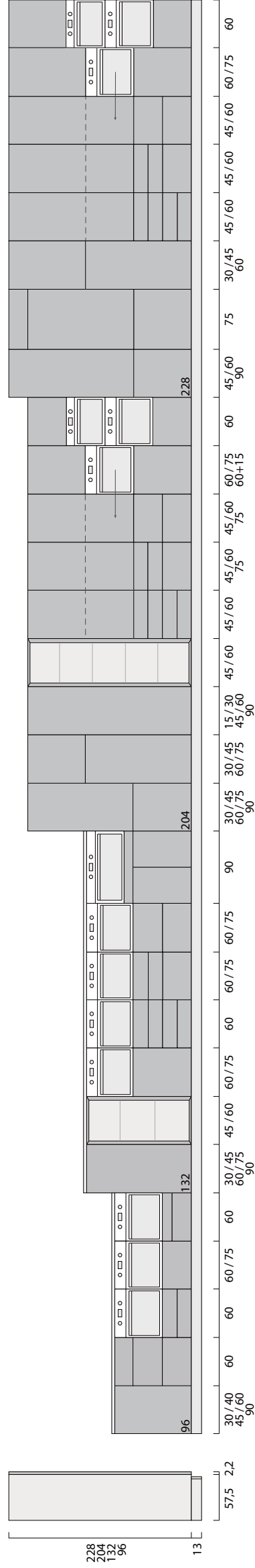

## COLONNE ZOCCOLO H.6

### H.6 PLINTH COLUMNS

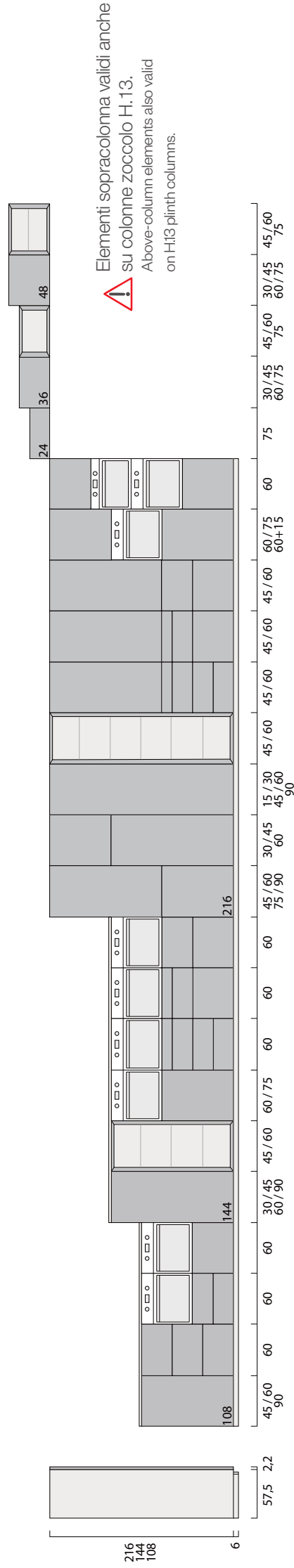

## ELEMENTI PER LIVING

### LIVING ELEMENTS

**i** COLONNE CON ANTE FINO A TERRA disponibili per piedi H.13 e piedi H.6. Per modistica disponibile con anta fino a terra vedere relativa sezione del listino. Solo per sistema Bridge.

COLUMNS WITH DOOR DOWN TO GROUND available for H.13 feet and H.6 feet. For available elements with door down to ground see respective section in the price list. Only for Bridge system.

**!** Per attrezzature interne e meccanismi di apertura vedere relative sezioni nel listino.  
For internal equipment and opening mechanisms, see respective sections in the price list.

**!** Per dimensioni dei singoli frontali vedere relative sezioni nel listino.  
For size of individual doors, see respective sections in the price list.

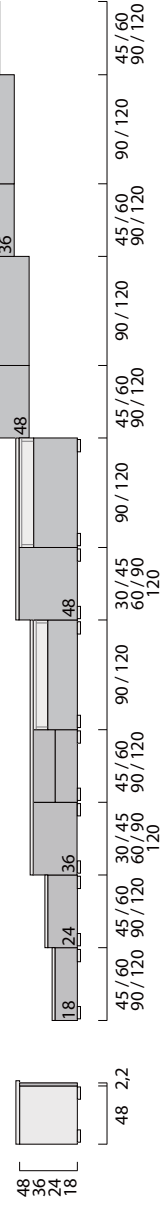



anta sp.22 mm costituita da un pannello composto da particelle in agglomerato di legno (conforme US EPA TSCA Title VI) nobilitato melaminico e bordato in abs o polipropilene.  
22 mm thick door made of a panel composed of particle board agglomeration of wood (compliant with US EPA TSCA Title VI) melamine coated with ABS or polypropylene edging.

**ANTE FINITURA OPACA SALICE**  
DOORS WITH WILLOW MATT FINISH

salix brown (opz.1521)



salix grey (opz.1522)



**ANTE FINITURA OPACA ROVERE**  
DOORS WITH OAK MATT FINISH

rovere chiaro (opz.5325)



rovere duna (opz.5326)



**ANTE FINITURA OPACA ABETE**  
DOORS WITH FIR MATT FINISH

abies moka (opz.4410)



abies bistro (opz.4411)



**ANTE FINITURA OPACA ROVERE VINTAGE**  
DOORS WITH VINTAGE OAK MATT FINISH

rovere grigio chiaro (opz.5328)



rovere grafite (opz.5327)



**ANTE FINITURA OPACA CASTAGNO**  
DOORS WITH CHESTNUT MATT FINISH

castagno bianco (opz.3055)



**ANTE FINITURA OPACA CANSIGLIO**  
DOORS WITH CANSIGLIO MATT FINISH

cansiglio terra bruciata (opz.1562)



**i**  
 Il Polipropilene è un prodotto di elevata qualità che trasmette al bordo un'alta resistenza ai prodotti acidi, solventi e raggi UV. Inoltre è 100% riciclabile.

Polypropylene is a high-quality product that imparts high resistance to acids, solvents, and UV rays to the edging. In addition, it is 100% recyclable.

**ANTE FINITURA OPACA MARMORIZZATA**  
**DOORS WITH MARBLED MATT FINISH**

marmo white yule (opz.9645)



marmo venato grigio (opz.8870)

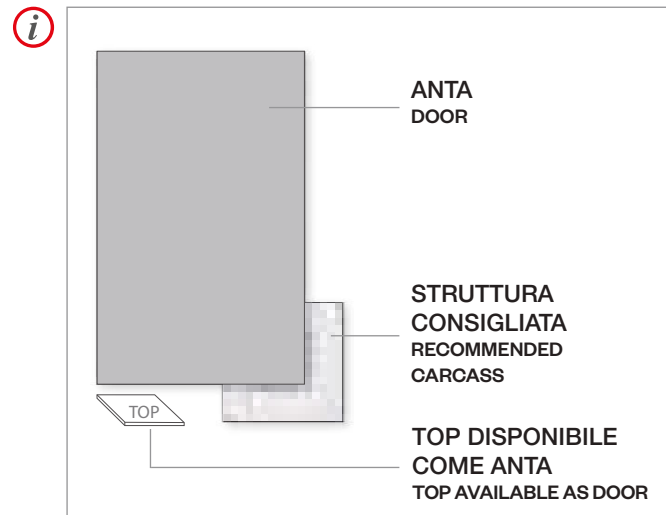

**ANTE FINITURA OPACA EFFETTO PIETRA**  
**DOORS WITH EFFECT STONE MATT FINISH**

juta stone (opz.9634)



grey stone (opz.9635)



bronze stone (opz.8869)



kea (opz.9646)



**ANTE FINITURA OPACA MALTA**  
**DOORS WITH MORTAR MATT FINISH**

bianco cristallo (opz.7445)



grigio nebbia (opz.9626)

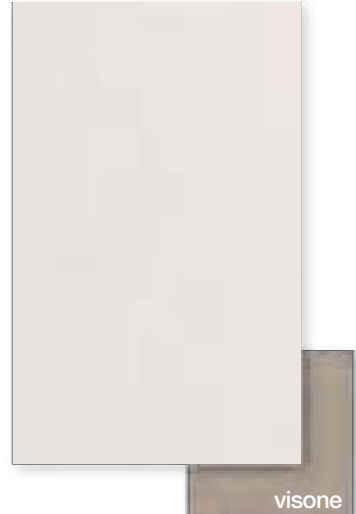

juta (opz.8863)

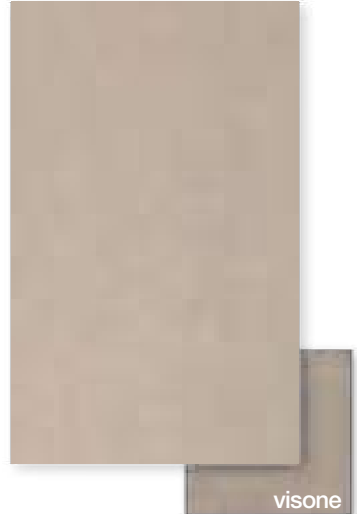

lavagna (opz.9627)





## ANTE FINITURA OSSIDATA DOORS WITH OXIDIZED FINISH

platino (opz.9661)



nicel (opz.9660)



oxide (opz.8871)



## ANTE EFFETTO RIGATINO DOORS WITH REED EFFECT



Rigatino orizzontale disponibile fino a H 204  
Note: Horizontal reed effect available up to H 204

rigatino verticale arena (opz.9647V)



rigatino orizzontale arena (opz.9647O)



rigatino verticale laguna (opz.9648V)



rigatino orizzontale laguna (opz.9648O)



## ANTE FINITURA SPAZZOLATA DOORS WITH BRUSHED FINISH

ottone chiaro (opz.7707)



rame brunito (opz.8868)



peltro (opz.9666)





**ANTE FINITURA SETA TINTA UNITA**  
**SOLID COLOR SILK FINISH DOORS**

**COLORI FREDDI COLD COLOURS**

bianco assoluto (opz.7450)

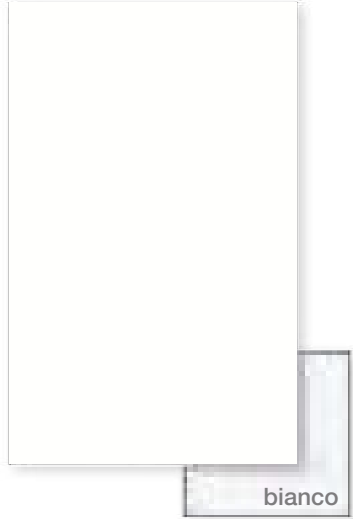

grigio chiaro (opz.9640)

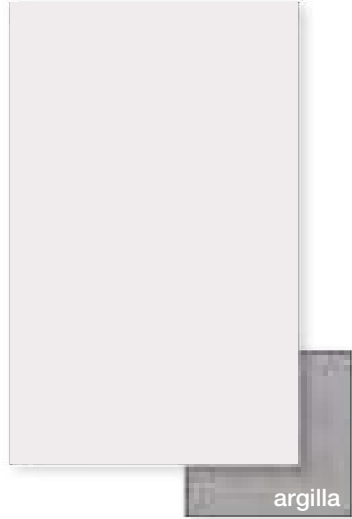

dove grey (opz.8971)

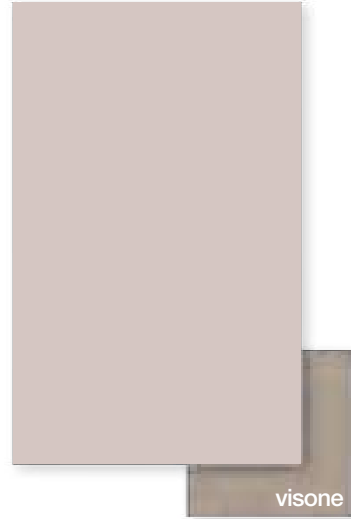

antracite (opz.9643)



**COLORI CALDI WARM COLOUR**

porcellana (opz.7703N)

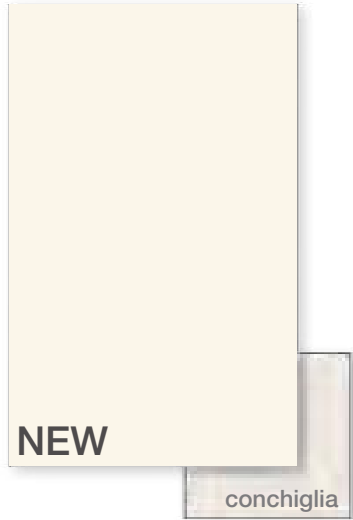

light cream (opz.7706)

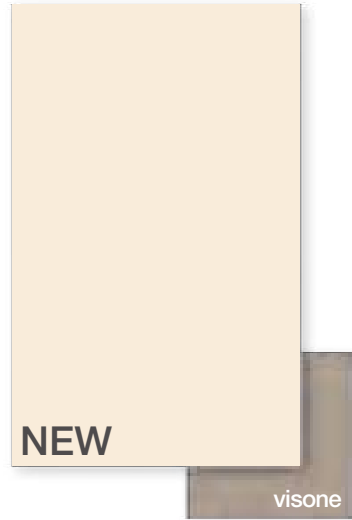

ecru (opz.9641)

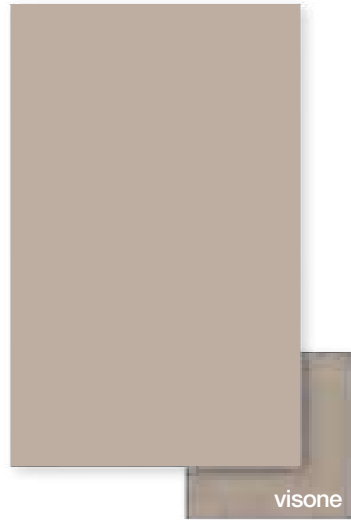

ebano (opz.8872)



verde marino (opz.8402N)

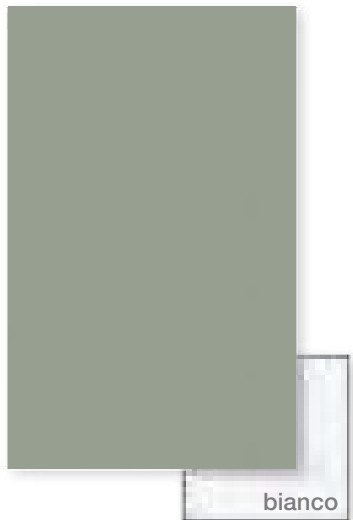

rosso cardinale (opz.8123)





anta sp.22 mm costituita da un pannello composto da particelle in agglomerato di legno (conforme US PA TSCA Title VI) con fronte esterno laccato super-opaco (3 gloss con trattamento ad eccimeri) o extralucido (95 gloss), ciclo di verniciatura a raggi UV, bordato in 4 lati polipropilene, retro anta in tinta.  
22 mm thick door made of a panel composed of particle board agglomeration of wood (compliant with US EPA TSCA Title VI) with exterior front in super-matt lacquer (3 gloss with "eccimeri" treatment) or in hi-gloss lacquer (95 gloss), UV ray painting cycle with 4 edges in polypropylene, back door matching.

**ANTE FINITURA OPACA**  
**DOORS WITH MATT FINISH**

bianco (opz.7405)

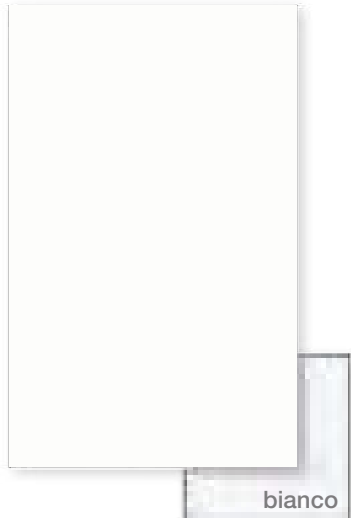

bianco neve (opz.7407)

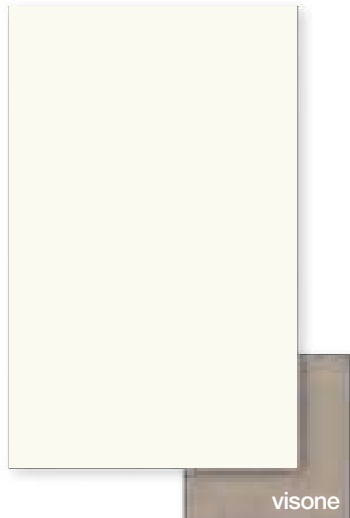

desert (opz.8941)



polvere (opz.9529)

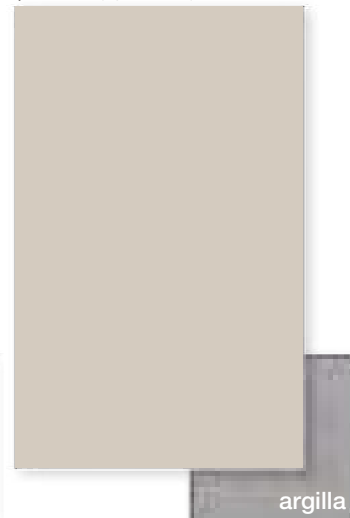

beige colorado (opz.7777)



antracite (opz.9558)



nero (opz.7895)



grigio minerale (opz.9523)



blu cobalto (opz.8383)

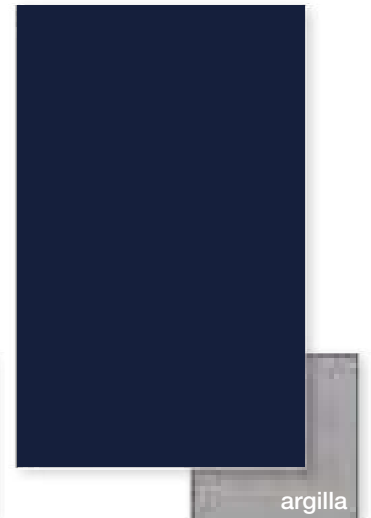

verde malga (opz.8477)



rosso cammeo (opz.8160)



giallo cadmio (opz.8255)



verde nilo (opz.8475)



rosso velvet (opz.8168)



Le ante laccate UV nella finitura opaca, sono sottoposte, nella parte frontale, a un processo di verniciatura attraverso la tecnologia "ECCIMERI". Tale trattamento conferisce alle ante una superficie ULTRA OPACA (3 gloss), con effetto SOFT-TOUCH e una maggiore resistenza al graffio.

UV lacquered doors in matt finish, are subjected to a painting process, in the front side, through "ECCIMERI" technology. This treatment gives the doors an ULTRA MATT surface (3 gloss), with SOFT-TOUCH effect and increased scratch resistance.



Neck cod. G43  
Lux cod. G48  
Bridge cod. 296  
Head cod. 297

## ANTE FINITURA LUCIDA DOORS WITH GLOSSY FINISH

bianco (opz.7406)



desert (opz.8942)



polvere (opz.9530)



antracite (opz.9559)

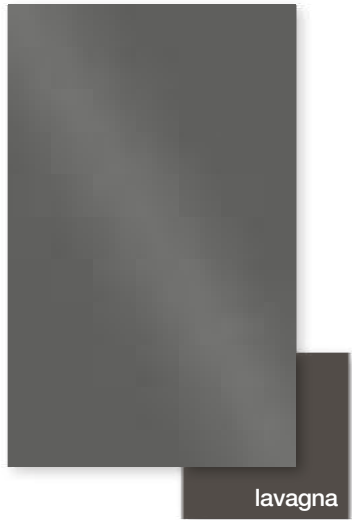

nero (opz.7896)



beige colorado (opz.7778)



grigio minerale (opz.9524)



rosso cammeo (opz.8164)



# LACCATO UV BORDO BICOLORE EFFETTO VETRO

UV LACQUERED WITH GLASS EFFECT BICOLOUR EDGE



COLORI IN PRONTA CONSEGNA  
AVAILABLE COLOURS

anta sp.22 mm costituita da un pannello composto da particelle in agglomerato di legno (conforme US PA TSCA Title VI) con fronte esterno laccato super-opaco (3 gloss con trattamento ad eccimeri) o extralucido (95 gloss), ciclo di verniciatura a raggi UV, bordato in 4 lati con bordo bicolore in PMMA finitura titanio, retro anta in tinta.  
22 mm thick door made of a panel composed of particle board agglomeration of wood (compliant with US EPA TSCA Title VI) with exterior front in super-matt lacquer (3 gloss with "eccimeri" treatment) or in hi-gloss lacquer (95 gloss), UV ray painting cycle with titanium finish 4 edges in PMMA, back door matching.

## ANTE FINITURA OPACA DOORS WITH MATT FINISH

bianco (opz.7405B)

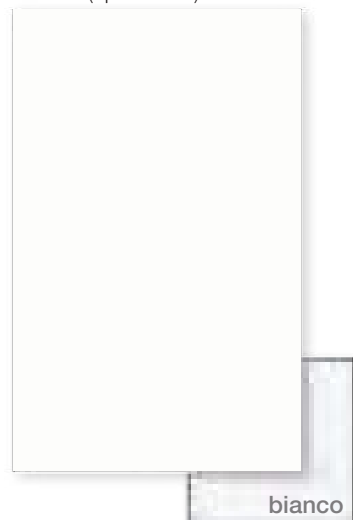

polvere (opz.9529B)

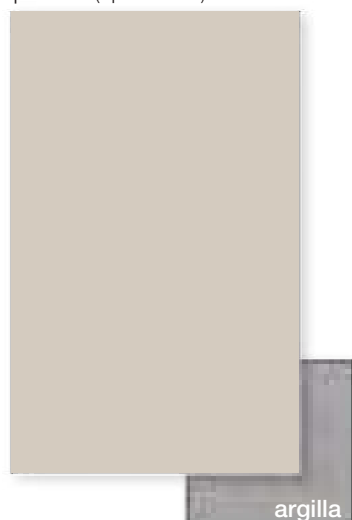

beige colorado (opz.7777B)



antracite (opz.9558B)



nero (opz.7895B)



grigio minerale (opz.9523B)



verde malga (opz.8477B)



rosso cammeo (opz.8160B)



verde nilo (opz.8475B)





Il PMMA, polimetil-metacrilato, è un prodotto di elevata qualità che trasmette al bordo un'alta trasparenza. È suddiviso in due porzioni, una stretta in tinta con il fronte anta e una larga finitura titanio 29 gloss. Resistente ad acidi, solventi e raggi UV.

PMMA, polymethyl methacrylate, is a high quality product that imparts high transparency to the edge. It is divided into two portions, a narrow to match the door's front and a wide titanium finish 29 gloss. Resistant to acids, solvents and UV rays.

Neck cod. G43  
 Lux cod. G48  
 Bridge cod. 296  
 Head cod. 297

## ANTE FINITURA LUCIDA DOORS WITH GLOSSY FINISH

bianco (opz.7406B)



polvere (opz.9530B)

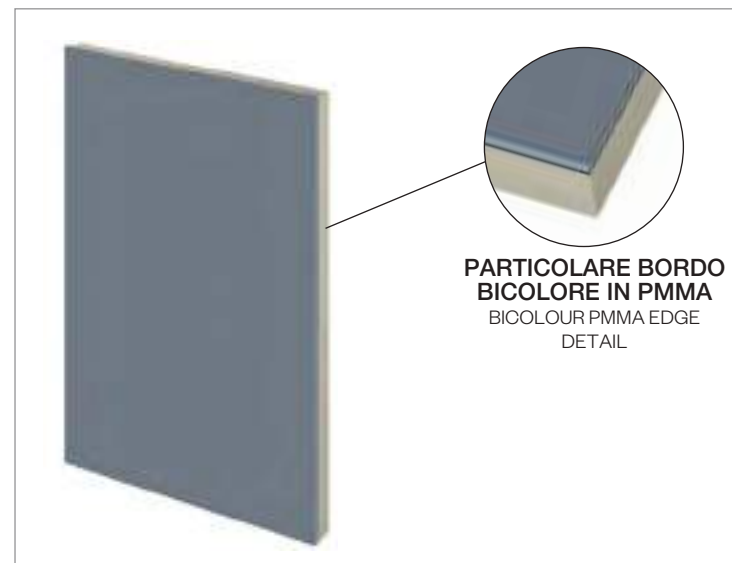
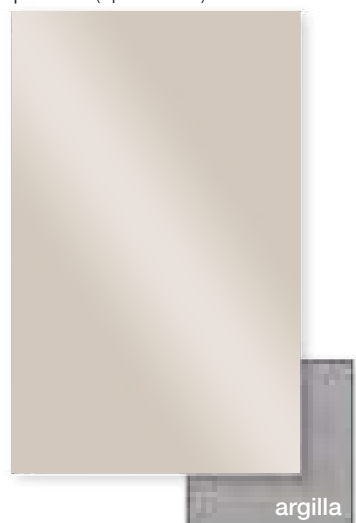

**i** anta effetto vetro grigio minerale opaco con bordo bicolore finitura titanio (opz.9523B)  
 Matt mineral gray glass effect door with bicolour titanium finish edge

beige colorado (opz.7778B)



antracite (opz.9559B)

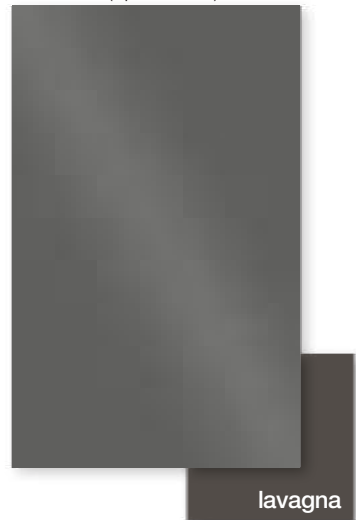

nero (opz.7896B)



grigio minerale (opz.9524B)



rosso cammeo (opz.8164B)





anta sp.22 mm costituita da un pannello composto da particelle in agglomerato di legno (supporto P3 conforme alla normativa US EPA TSCA Title VI) con finitura sul lato frontale realizzata da un mix di polveri di legno, cariche minerali e leganti resinosi con bordo in ABS 10/10 e retro melaminico in tinta.  
22 mm thick door made of a panel composed of particle board agglomeration of wood (P3 support compliant with US EPA TSCA Title VI) with surface finish on the front side, made from a mix of wood powders, mineral fillers and resinous binders with 10/10 ABS edge and melamine rear, matching the reference finish.

## ANTE FINITURA AREIA DOORS AREIA FINISH

areia beige (opz.MT02)

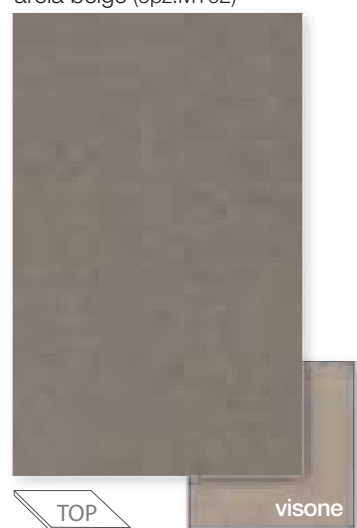

areia grigio (opz.MT03)



areia nero (opz.MT04)



## ANTE FINITURA GIPSO DOORS GIPSO FINISH

gipso grigio (opz.MT23)

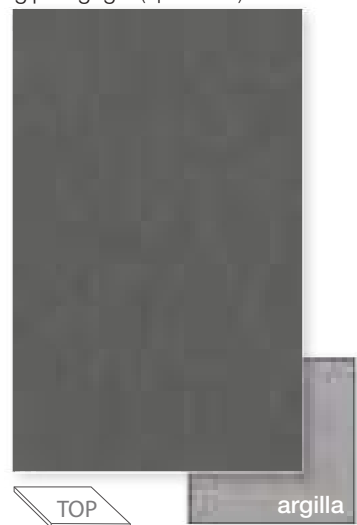

gipso rosso (opz.MT24)



gipso verde (opz.MT22)



**i**  
Il MATHERA è una superficie di ultima generazione coperta da brevetto, composta da materiali provenienti da filiere di recupero e resine basso emissive. Un materiale innovativo totalmente riciclabile.

The MATHERA is a latest generation surface covered by patent, made up of materials from recycled supply chains and low-emissivity resins. An innovative material that is totally recyclable.

**Neck** cod. G38  
**Lux** cod. G39  
**Bridge** cod. 300  
**Head** cod. 301

## ANTE FINITURA SELCE DOORS FLINT FINISH

selce grigio chiaro (opz.MT13)  
venatura orizzontale

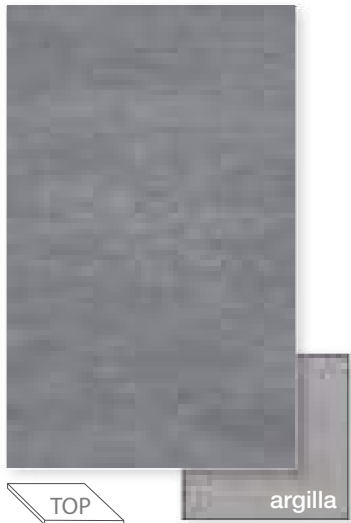

selce nero (opz.MT14)  
venatura orizzontale



**i**

**MATHERA** viene proposta in tre diverse finiture:

**AREIA:** caratterizzata da una texture più uniforme e compatta, reinterpreta le tecniche di bocciardatura tradizionalmente ispirate dalla pietra arenaria, nelle finiture: areia beige (opz.MT02), areia grigio (opz.MT03), areia nero (opz.MT04)

**GIPSO:** superficie morbida, declinata in una palette di colori tenui e pastosi che interpretano la consistenza malleabile del gesso e la sua natura di materiale tenero di origine calcarea, nelle finiture: gipso grigio (opz.MT23), gipso rosso (opz.MT24), gipso verde (opz.MT22)

**SELCE:** ispirata al mondo delle pietre a spacco, rielabora in veste originale e creativa le qualità estetiche dell'ardesia. Si caratterizza da ritmiche increspature assimilabili ai segni impressi sulle superfici lapidee dalle lavorazioni di cava, nelle finiture: selce grigio chiaro venatura verticale (opz.MT13), selce nero venatura verticale (opz.MT14)

**MATHERA** is available in three different finishes:

**AREIA:** Characterized by a more uniform and compact texture, Areia reinterprets the bush hammering techniques traditionally inspired by sandstone. finishes: beige areia (opz.MT02), grey areia (opz.MT03), black areia (opz.MT04)

**GIPSO:** Soft surface, declined in a palette of soft and mellow colors. Gipso is a neutral finish that interprets the malleable consistency of gypsum and its nature as a soft material of limestone origin, finishes: grey gipso (opz.MT23), red gipso (opz.MT24), green gipso (opz.MT22)

**SELCE:** Inspired by the world of split stones, Selce reworks the aesthetic qualities of slate in an original and creative way. It is characterized by rhythmic ripples similar to the signs imprinted on the stone surfaces by quarrying, finishes: light grey flint vertical grain (opz.MT13), black flint vertical grain (opz.MT14)



anta sp.22 mm costituita da un pannello composto da particelle in agglomerato di legno (conforme US EPA TSCA Title VI) con esterno rivestito in foglia polimerica PET finitura spazzolata lucida effetto metallo e retro in melaminico. Bordatura 4 lati in ABS 10/10.  
22 mm thick door made of a panel composed of particle board agglomeration of wood (US EPA TSCA Title VI compliant) with leaf-covered exterior polymer PET metal effect glossy brushed finish and melamine interior. 4 sides ABS10/10 edging.

**ANTE FINITURA SPAZZOLATA LUCIDA EFFETTO METALLO**  
**DOORS METAL EFFECT GLOSSY BRUSHED FINISH**

metal brass (opz.8848)

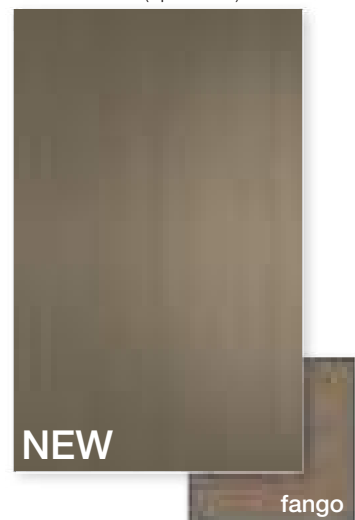

metal brown (opz.8849)

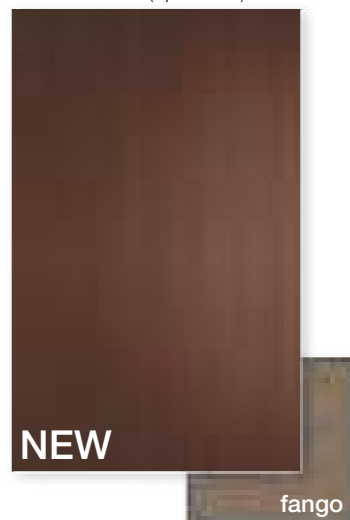

metal dark night (opz.7871)

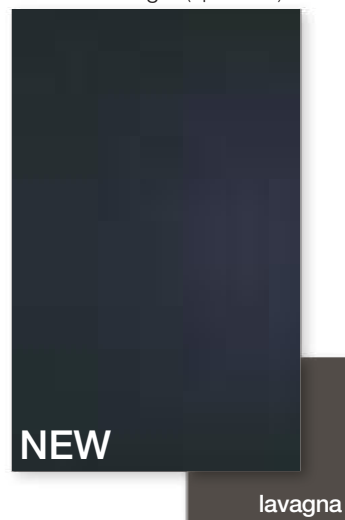

**FINITURE RETRO ANTA IN MELAMINICO**

REAR DOOR FINISHES IN MELAMINE

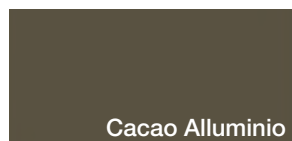

PER ANTA:  
FOR DOOR:

metal brass (opz.8848)  
metal brown (opz.8849)



PER ANTA:  
FOR DOOR:

metal dark night (opz.7871)



Il polietilenteraftelato, conosciuto sotto l'abbreviazione PET, è una materia sintetica moderna, ecologica e riciclabile al 100%. 

Le principali caratteristiche che lo diversificano dalle tradizionali materie plastiche sono la flessibilità e l'eccellente stabilità dimensionale che lo rendono inalterabile nel tempo. L'elevata resistenza al calore, all'usura ed all'invecchiamento termico fanno del PET uno dei materiali più innovativi ed orientati al futuro.

The polyethylene terephthalate, abbreviated as PET, is a modern synthetic material, environmentally friendly and 100% recyclable. The main features that distinguish it from traditional plastics are its flexibility and excellent dimensional stability, which renders it unalterable over time. Its high resistance to heat, wear and thermal ageing makes PET one of the most innovative, future-oriented materials.

**Neck** cod. G40  
**Lux** cod. G45  
**Bridge** cod. 290  
**Head** cod. 291





anta sp.22 mm costituita da un pannello composto da particelle in agglomerato di legno (conforme US EPA TSCA Title VI) impiallacciato rovere fiamma verticale WOOD con bordo polipropilene 10/10.  
22 mm thick door made of a panel composed of particle board agglomeration of wood (US EPA TSCA Title VI compliant) in vertical flame stained oak veneered WOOD with 10/10 polypropylene edge.

## ANTE FINITURA IMPIALLACCIATA ROVERE TINTO A PORO APERTO DOORS WITH OPEN PORE STAINED OAK VENEERED FINISH

rovere naturale (opz.5442)  
fiamma verticale



conchiglia

rovere grey (opz.5443)  
fiamma verticale



conchiglia

rovere moscato (opz.5444)  
fiamma verticale

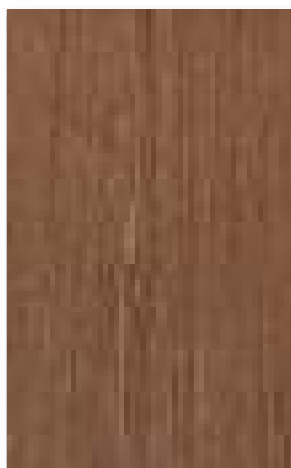

fango

rovere fumè (opz.5445)  
fiamma verticale



lavagna

## ANTE FINITURA IMPIALLACCIATA ROVERE LACCATO A PORO APERTO DOORS WITH OPEN PORE LACQUERED VENEERED FINISH

rovere bianco (opz.5441)  
fiamma verticale

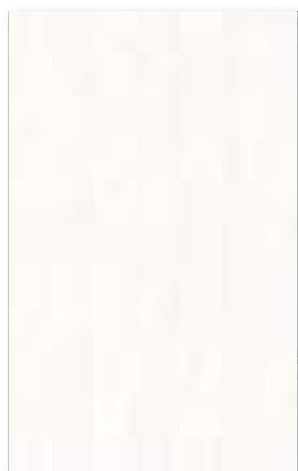

bianco

rovere nero (opz.5446)  
fiamma verticale

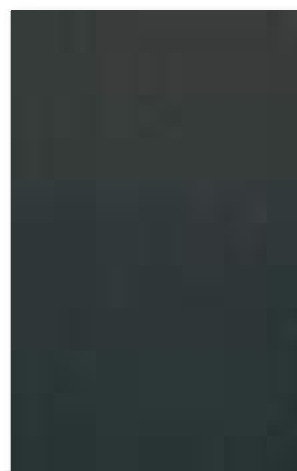

lavagna



Le ante impiallacciate WOOD sono sottoposte a un processo di verniciatura trasparente mediante tecnologia ad "ECCIMERI".  
Tale trattamento conferisce alle ante una superficie ULTRA OPACA (circa 5 gloss), con effetto SOFT-TOUCH e una maggiore resistenza al graffio.  
La parte posteriore dell'anta non è soggetta al trattamento sopraindicato, viene rivestita con impiallaccio in tinta ma con caratteristiche differenti rispetto al frontale.

The WOOD veneered door is subject to a transparent painting process using the "ECCIMERI" technology.  
This treatment gives the doors an ULTRA MATT surface (about 5 gloss), with a SOFT-TOUCH effect and a greater scratch resistance. The rear part of the door is not subject to the above treatment, it is covered with matching veneer wood that has different characteristics than the front.

# LAMINATO CANNETTATO

REED-EFFECT LAMINATE

anta sp.22 mm costituita da un pannello composto da particelle in agglomerato di legno (conforme US EPA TSCA Title VI) rivestito frontalmente con laminato Sp. 4 mm con effetto cannettato, bordato ABS 10/10 in tinta.

22 mm thick door made of a panel composed of particle board agglomeration of wood (US EPA TSCA Title VI compliant) with front 4 mm thick reed-effect laminate and 10/10 ABS edge.

Neck cod. G44

Lux cod. G49

Bridge cod. 298

Head cod. 299

caravella light



caravella dark



DISPONIBILI  
DA SETTEMBRE  
FROM SEPTEMBER

## FINITURE RETRO ANTA IN LAMINATO

REAR DOOR FINISHES IN LAMINATE



**TELAIO ALLUMINIO FINITURA OPACA**  
MATT FINISH ALUMINIUM FRAME

---

**DI SERIE:** telaio alluminio verniciato titanio sp.22 mm vetro extrachiaro, bronzo o fumè

**STANDARD:** 22 mm th. titanium painted aluminium frame extra-clear, bronze or fumè glass



telaio titanio con vetro extrachiaro  
(opt.TIEXC)  
titanium frame with extra-clear glass  
(opt.TIEXC)



telaio titanio con vetro bronzo  
(opt.TIBRZ)  
titanium frame with bronze glass  
(opt.TIBRZ)



telaio titanio con vetro fumè  
(opt.TIFUM)  
titanium frame with fumè glass  
(opt.TIFUM)

**A RICHIESTA:** telaio alluminio verniciato nero sp.22 mm vetro extrachiaro, bronzo o fumè

**ON REQUEST:** 22 mm th. black painted aluminium frame extra-clear, bronze or fumè glass



telaio nero con vetro extrachiaro  
(opt.NIEXC)  
black frame with extra-clear glass  
(opt.NIEXC)



telaio nero con vetro bronzo  
(opt.NIBRZ)  
black frame with bronze glass  
(opt.NIBRZ)



telaio nero con vetro fumè  
(opt.NIFUM)  
black frame with fumè glass  
(opt.NIFUM)

## TELAIO ALLUMINIO FINITURA OPACA MATT FINISH ALUMINIUM FRAME

**A RICHIESTA:** telaio alluminio verniciato silver dark sp.22 mm vetro extrachiaro, bronzo o fumè

**ON REQUEST:** 22 mm th. silver dark painted aluminium frame extra-clear, bronze or fumè glass



telaio silver dark con vetro extrachiaro  
(opz.PIEXC)  
silver dark frame with extra-clear glass  
(opt.PIEXC)



telaio silver dark con vetro bronzo  
(opz.PIBRZ)  
silver dark frame with bronze glass  
(opt.PIBRZ)



telaio silver dark con vetro fumè  
(opz.PIFUM)  
silver dark frame with fumè glass  
(opt.PIFUM)

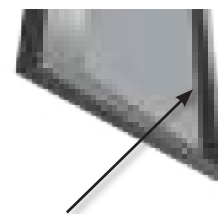

Particolare presa su  
interno del montante  
del telaio alluminio.  
Internal grip handle detail  
for aluminium frame doors.

**A RICHIESTA:** telaio alluminio verniciato ottone sp.22 mm vetro extrachiaro, bronzo o fumè

**ON REQUEST:** 22 mm th. brass painted aluminium frame extra-clear, bronze or fumè glass



telaio ottone con vetro extrachiaro  
(opz.EIEXC)  
brass frame with extra-clear glass  
(opt.EIEXC)



telaio ottone con vetro bronzo  
(opz.EIBRZ)  
brass frame with bronze glass  
(opt.EIBRZ)



telaio ottone con vetro fumè  
(opz.EIFUM)  
brass frame with fumè glass  
(opt.EIFUM)

## TELAIO ALLUMINIO FINITURA OPACA MATT FINISH ALUMINIUM FRAME

---

**A RICHIESTA:** telaio alluminio verniciato rame brunito sp.22 mm vetro extrachiaro, bronzo o fumè

**ON REQUEST:** 22 mm th. copper brunished painted aluminium frame extra-clear, bronze or fumè glass



telaio rame brunito con vetro extrachiaro  
(opz.RIEXC)  
copper brunished frame with extra-clear glass  
(opt.RIEXC)



telaio rame brunito con vetro bronzo  
(opz.RIBRZ)  
copper brunished frame with bronze glass  
(opt.RIBRZ)



telaio rame brunito con vetro fumè  
(opz.RIFUM)  
copper brunished frame with fumè glass  
(opt.RIFUM)

**A RICHIESTA:** telaio alluminio verniciato terra d'ombra sp.22 mm vetro extrachiaro, bronzo o fumè

**ON REQUEST:** 22 mm th. shadow earth painted aluminium frame extra-clear, bronze or fumè glass



telaio terra d'ombra con vetro  
extrachiaro (opz.MIEXC)  
shadow earth frame with extra-clear glass  
(opt.MIEXC)



telaio terra d'ombra con vetro  
bronzo (opz.MIBRZ)  
shadow earth frame with bronze  
glass (opt.MIBRZ)



telaio terra d'ombra con vetro  
fumè (opz.MIFUM)  
shadow earth frame with fumè  
glass (opt.MIFUM)

# VETRO CANNETTATO SATINATO

REED EFFECT SATINED GLASS

## TELAIO ALLUMINIO FINITURA OPACA MATT FINISH ALUMINIUM FRAME

**A RICHIESTA:** telaio alluminio verniciato titanio sp.22 mm vetro cannettato satinato: bianco, bronzo o fumè

**ON REQUEST:** 22 mm th. titanium painted aluminium frame with reed effect satin glass: white, bronze or fumè



telaio titanio con vetro cannettato satinato bianco (opz.TNBIA)  
titanium frame with reed effect white satin etched glass (opt.TNBIA)



telaio titanio con vetro cannettato satinato bronzo (opz.TNBRZ)  
titanium frame with reed effect bronze satin etched glass (opt.TNBRZ)



telaio titanio con vetro cannettato satinato fumè (opz.TNFUM)  
titanium frame with reed effect fumè satin etched glass (opt.TNFUM)

**A RICHIESTA:** telaio alluminio verniciato nero sp.22 mm vetro cannettato satinato: bianco, bronzo o fumè

**ON REQUEST:** 22 mm th. black painted aluminium frame with reed effect satin glass: white, bronze or fumè



telaio nero con vetro cannettato satinato bianco (opz.NNBIA)  
black frame with reed effect white satin etched glass (opt.NNBIA)



telaio nero con vetro cannettato satinato bronzo (opz.NNBRZ)  
black frame with reed effect bronze satin etched glass (opt.NNBRZ)



telaio nero con vetro cannettato satinato fumè (opz.NNFUM)  
black frame with reed effect fumè satin etched glass (opt.NNFUM)

## TELAIO ALLUMINIO FINITURA OPACA MATT FINISH ALUMINIUM FRAME

---

**A RICHIESTA:** telaio alluminio verniciato silver dark sp.22 mm vetro cannettato satinato: bianco, bronzo o fumè

**ON REQUEST:** 22 mm th. silver dark painted aluminium frame with reed effect satin glass: white, bronze or fumè



telaio silver dark con vetro cannettato satinato bianco (opz.FNBIA)  
silver dark frame with reed effect white satin etched glass (opt.FNBIA)



telaio silver dark con vetro cannettato satinato bronzo (opz.FNBRZ)  
silver dark frame with reed effect bronze satin etched glass (opt.FNBRZ)



telaio silver dark con vetro cannettato satinato fumè (opz.FNFUM)  
silver dark frame with reed effect fumè satin etched glass (opt.FNFUM)

**A RICHIESTA:** telaio alluminio verniciato ottone sp.22 mm vetro cannettato satinato: bianco, bronzo o fumè

**ON REQUEST:** 22 mm th. brass painted aluminium frame with reed effect satin glass: white, bronze or fumè

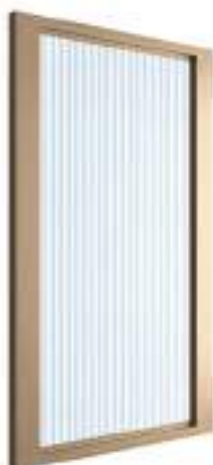

telaio ottone con vetro cannettato satinato bianco (opz.ENBIA)  
brass frame with reed effect white satin etched glass (opt.ENBIA)

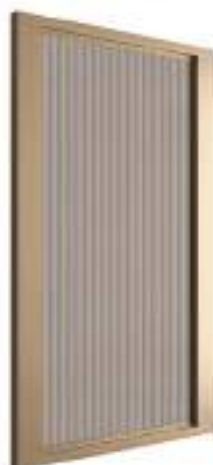

telaio ottone con vetro cannettato satinato bronzo (opz.ENBRZ)  
brass frame with reed effect bronze satin etched glass (opt.ENBRZ)

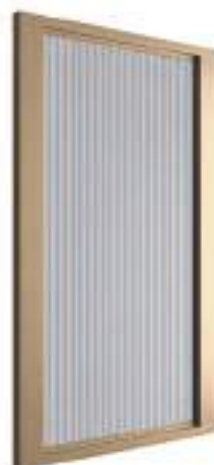

telaio ottone con vetro cannettato satinato fumè (opz.ENFUM)  
brass frame with reed effect fumè satin etched glass (opt.ENFUM)



## TELAIO ALLUMINIO FINITURA OPACA MATT FINISH ALUMINIUM FRAME

---

**A RICHIESTA:** telaio alluminio verniciato rame brunito sp.22 mm vetro cannettato satinato:  
bianco, bronzo o fumè

**ON REQUEST:** 22 mm th. copper brunished painted aluminium frame with reed effect satin glass: white, bronze or fumè

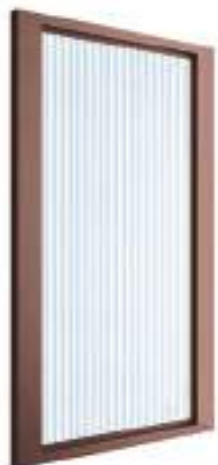

telaio rame brunito con vetro cannettato satinato bianco (opz.RNBIA)  
copper brunished frame with reed effect white satin etched glass (opt.RNBIA)



telaio rame brunito con vetro cannettato satinato bronzo (opz.RNBRZ)  
copper brunished frame with reed effect bronze satin etched glass (opt.RNBRZ)

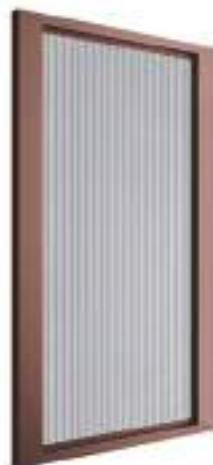

telaio rame brunito con vetro cannettato satinato fumè (opz.RNFUM)  
copper brunished frame with reed effect fumè satin etched glass (opt.RNFUM)

**A RICHIESTA:** telaio alluminio verniciato terra d'ombra sp.22 mm vetro cannettato satinato:  
bianco, bronzo o fumè

**ON REQUEST:** 22 mm th. shadow earth painted aluminium frame with reed effect satin glass: white, bronze or fumè



telaio terra d'ombra con vetro cannettato satinato bianco (opz.MNBIA)  
shadow earth frame with reed effect white satin etched glass (opt.MNBIA)



telaio terra d'ombra con vetro cannettato satinato bronzo (opz.MNBRZ)  
shadow earth frame with reed effect bronze satin etched glass (opt.MNBRZ)



telaio terra d'ombra con vetro cannettato satinato fumè (opz.MNFUM)  
shadow earth frame with reed effect fumè satin etched glass (opt.MNFUM)

# SCHIENA EFFETTO MARMO

BACK PANEL MARBLE EFFECT

## PENSILI

WALL UNITS

H 36-48	L 45 L 60 L 90
H 60	L 60
H 72	L 45 L 60 L 90
H 96	L 45 L 60 L 90
H 108	L 45 L 60 L 90
H 120	L 45

## BASI

BASE UNITS

H 72	L 45 L 60 L 90
H 75	L 45 L 60 L 90
H 84	L 45 L 60 L 90

## COLONNE

COLUMNS

H 108	L 45 L 60 L 90
H 132	L 45 L 60 L 90
H 144	L 45 L 60 L 90
H 204	L 45 L 60 L 90
H 216	L 45 L 60 L 90

 **solo per elementi a vetro**  
only for glass elements



## COLORI SCHIENA BACK PANEL COLOUR



alabastro finitura MN (opz.6014)



calacatta finitura MN (opz.6019)



dark finitura MN (opz.6133)



## CERNIERA 110° BLUMOTION DI SERIE

STANDARD 110° BLUMOTION HINGES

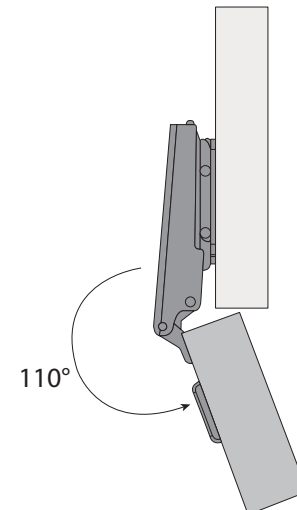
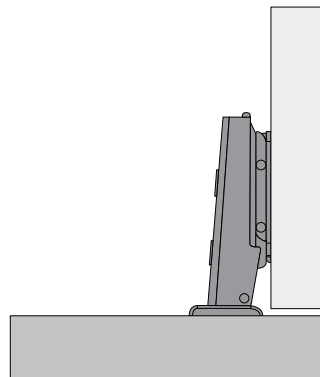
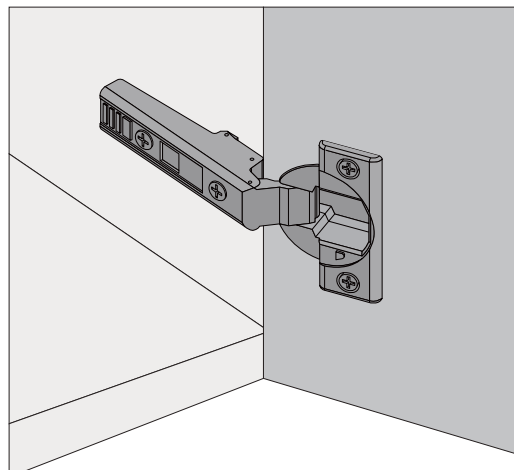

## CERNIERA 155° BLUMOTION

155° BLUMOTION HINGES

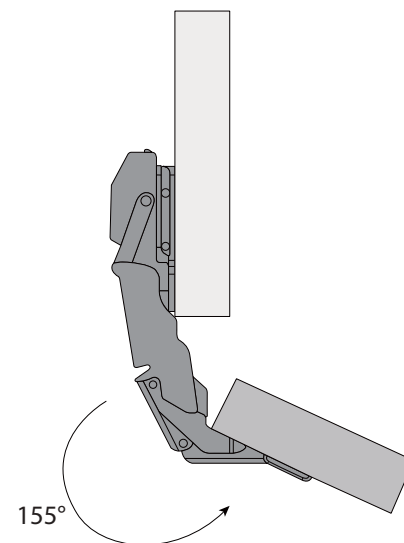
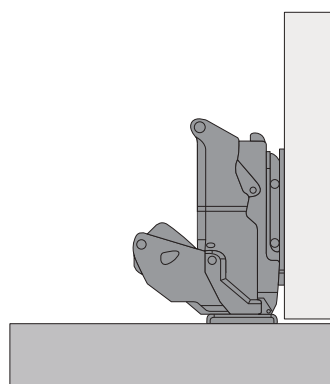
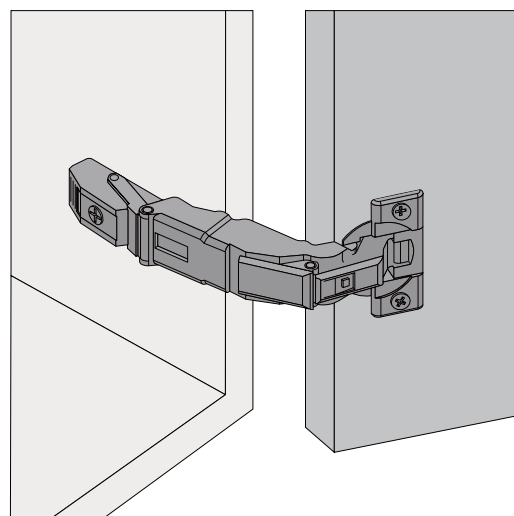

**!** Le cerniere 155° Blumotion nei pensili sono a richiesta. Sono invece di serie nei pensili colapiatti. Blumotion 155° hinges in wall units are optional. They are, however, standard in the plate rack wall units.

## APERTURA A RIBALTA

FLAP OPENING

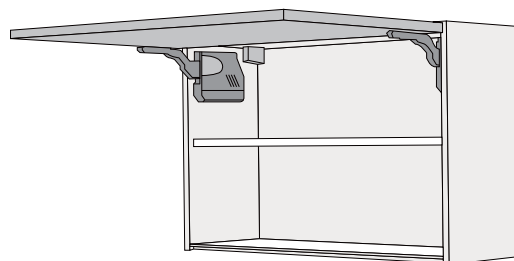

**DI SERIE**  
STANDARD



**MOTORIZZATO**  
**SERVO-DRIVE**  
SERVO-DRIVE  
MOTORIZED  
(Opz. 007)

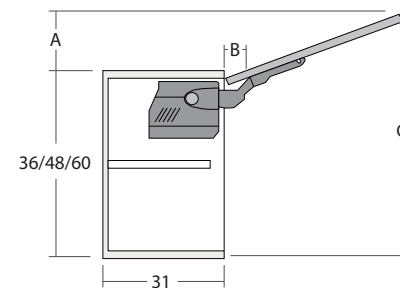

Limitatore angolo di apertura cod. 5620010  
Opening angle limiter code 5620010

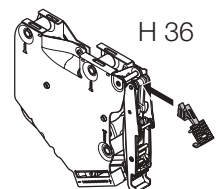

H 36

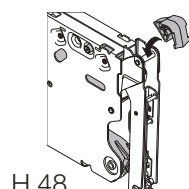

H 48

	A	B	C
H 36	11,5	3,5	37
H 48	15	3,5	49
H 60	18,5	3,5	61

## APERTURA VERTICALE OBLIQUA

OBLIQUE VERTICAL OPENING

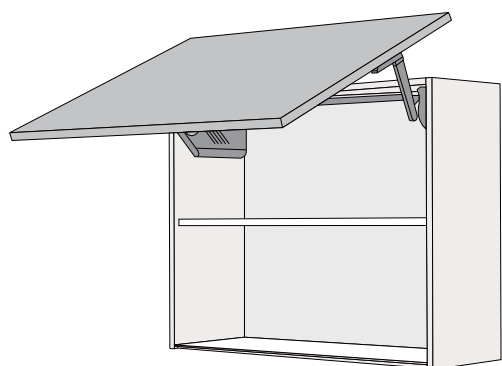

**DI SERIE**  
STANDARD



**MOTORIZZATO**  
**SERVO-DRIVE**  
SERVO-DRIVE  
MOTORIZED  
(Opz. 007)

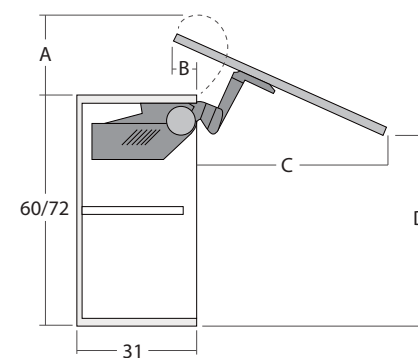

	A	B	C	D
H 60	18	9,6	46,5	53,5
H 72	18	9,6	57	61

## APERTURA VERTICALE

VERTICAL OPENING

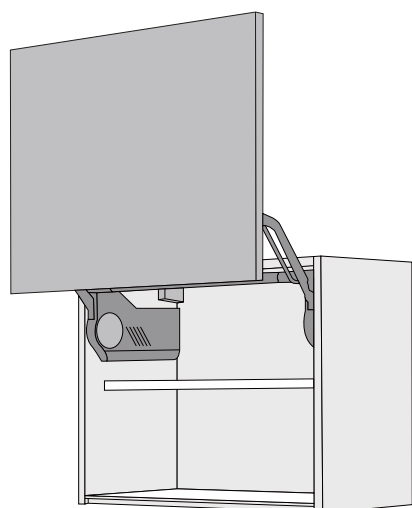

**DI SERIE**  
STANDARD



**MOTORIZZATO**  
**SERVO-DRIVE**  
SERVO-DRIVE  
MOTORIZED  
(Opz. 007)

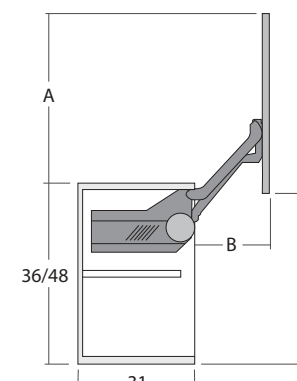

	A	B	C
H 36	34	23,5	34,5
H 48	43	28,5	43,5

## APERTURA ANTE A PACCHETTO

LIFT-UP FOLDING OPENING

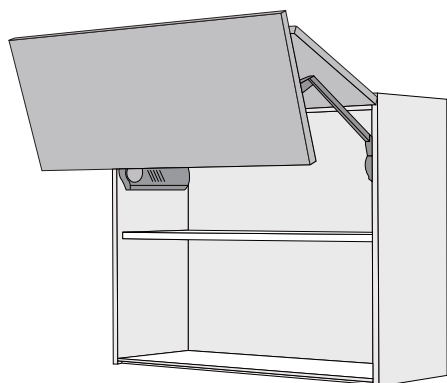

**DI SERIE**  
STANDARD



**MOTORIZZATO**  
**SERVO-DRIVE**  
SERVO-DRIVE  
MOTORIZED  
(Opz. 007)

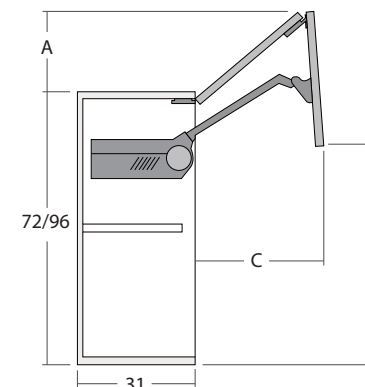

	A	B	C
H 72	16,5	54	41
H 96	20	69	53

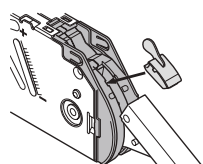

Limitatore angolo di apertura  
cod. 5620005  
Opening angle limiter  
code 5620005

## CERNIERA 110° BLUMOTION DI SERIE

STANDARD 110° BLUMOTION HINGES

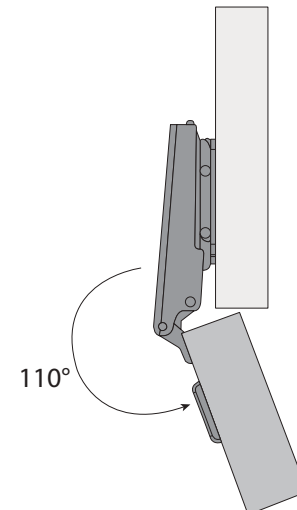
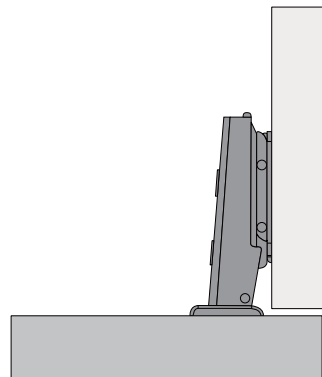
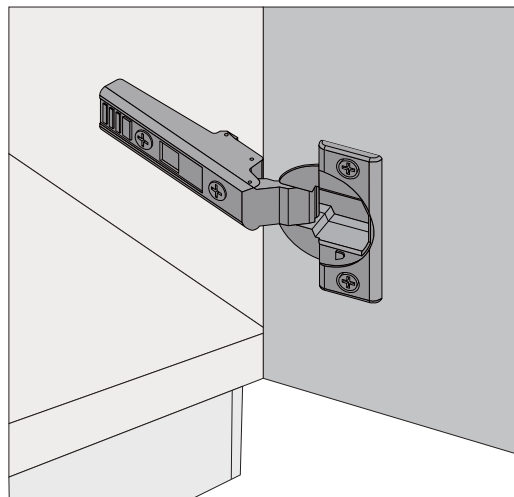

## CERNIERA 155° BLUMOTION

155° BLUMOTION HINGES

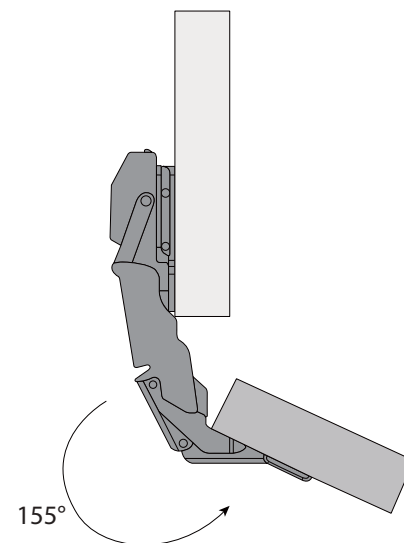
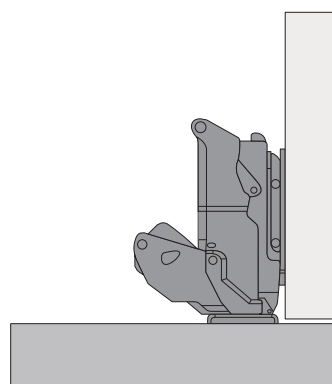
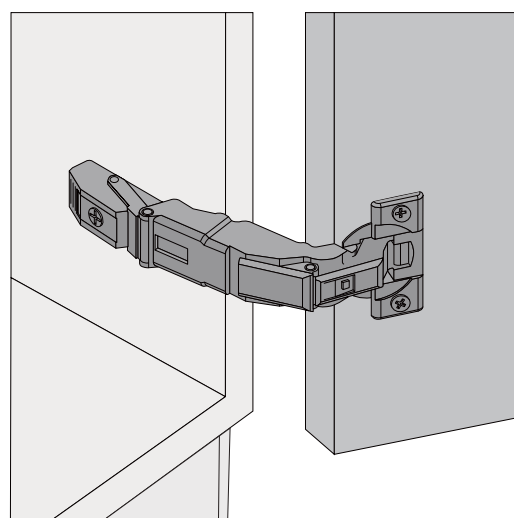

Le cerniere 155° Blumotion sono a richiesta. Sono invece di serie nelle basi angolo 95x95 e 110x110 e nelle basi e colonne con anta più cassetti, cestoni ed accessori estraibili interni. Blumotion 155° hinges are optional. They are, however, standard in the 95x95 and 110x110 corner bases and in the bases and columns with a door plus internal drawers, baskets and extractable accessories.

## CERNIERA PILASTRO BLUMOTION

PILLAR BLUMOTION HINGES

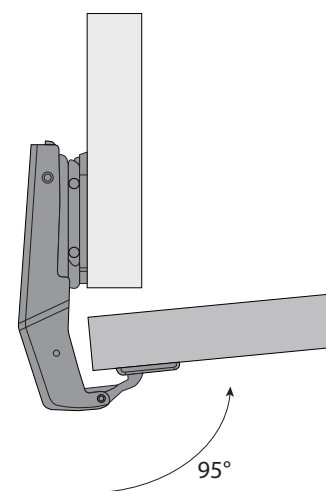
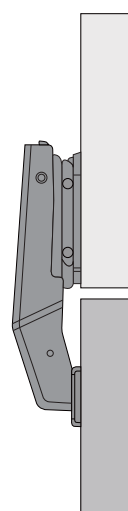
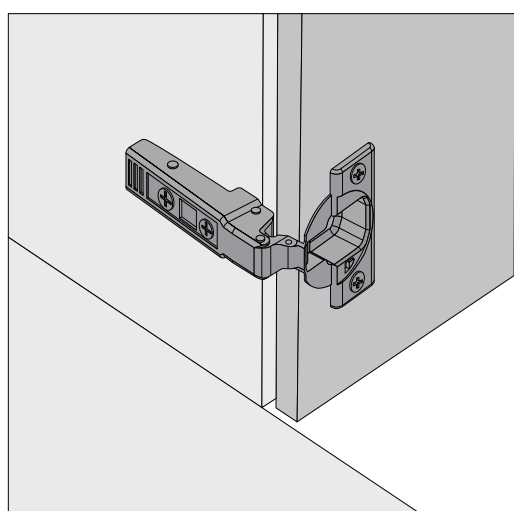

Le cerniere pilastro Blumotion sono di serie nelle basi angolo e nelle colonne angolo. Pillar Blumotion hinges are standard in the corner base units and in the corner columns.

# CASSETTI E CESTONI "INTIVO"

"INTIVO" DRAWERS AND BASKETS

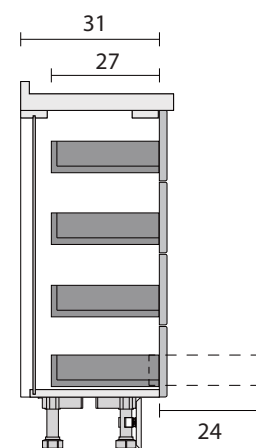
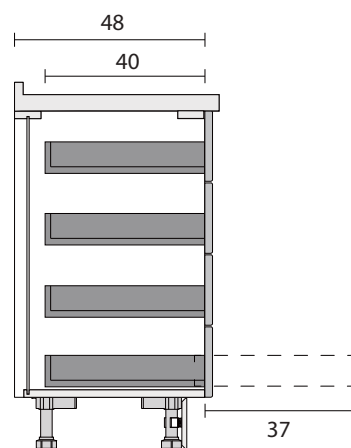
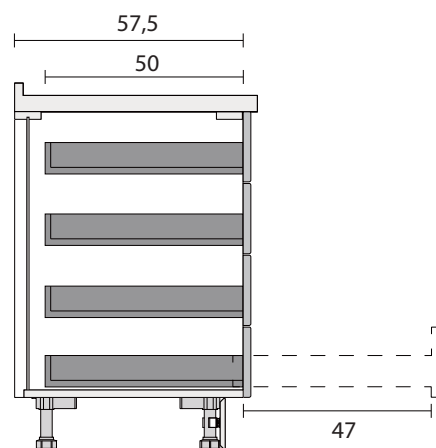
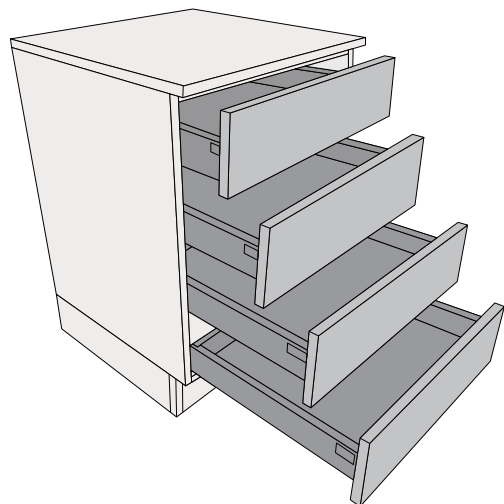

I sistemi "Intivo" garantiscono l'estrazione totale dei cassetti e cestoni e sono equipaggiati con fermo di fine corsa e sistema ad incastro per bloccaggio anti-sganciamento. Nei cassetti e cestoni con larghezza fino a 120 cm la portata dinamica è di 50 kg e 30 kg nelle profondità ridotte. Il movimento silenzioso ed ammortizzato è garantito per oltre 100.000 cicli di apertura/chiusura.

"Intivo" systems ensure full extraction of drawers and baskets and are equipped with end stop and interlocking system for anti-release locking. In drawers and baskets with widths up to 120 cm, the dynamic load capacity is 50 kg and 30 kg in shallow depths. The quiet, damped movement is guaranteed for more than 100,000 opening/closing cycles.

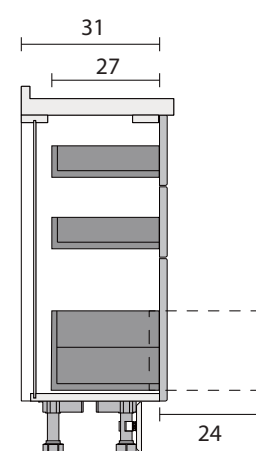
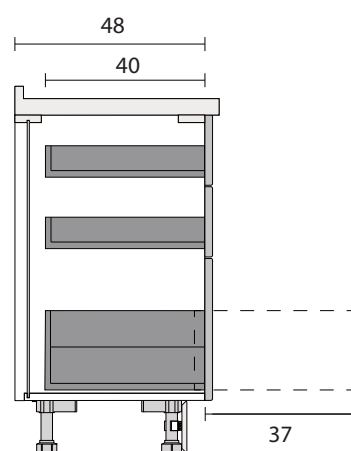
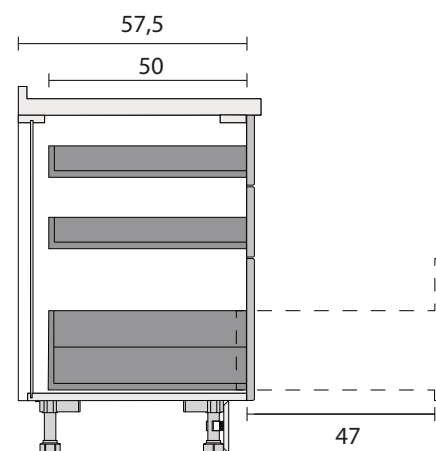
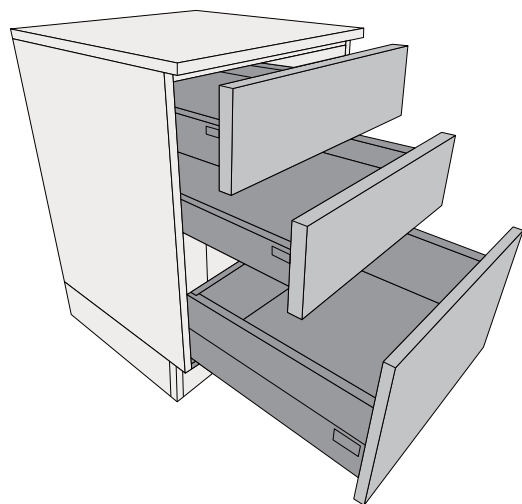

## DETTAGLIO CASSETTO E CESTONE "INTIVO"

DETAIL OF "INTIVO" DRAWER AND BASKETS

### CONSULTA EXTRANET:

CONSULT ON EXTRANET:

- Accessori e meccanismi interni
- Accessories and internal mechanisms

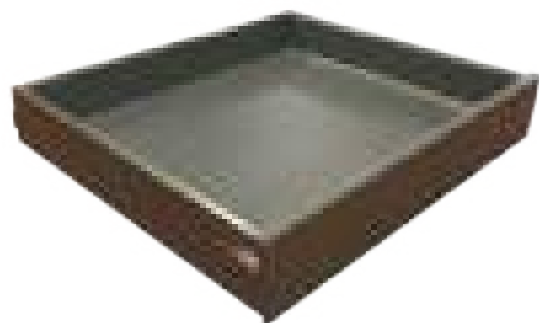
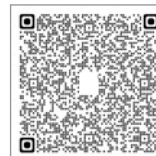

Finitura "Orion Grau"  
"Orion Grau" finish

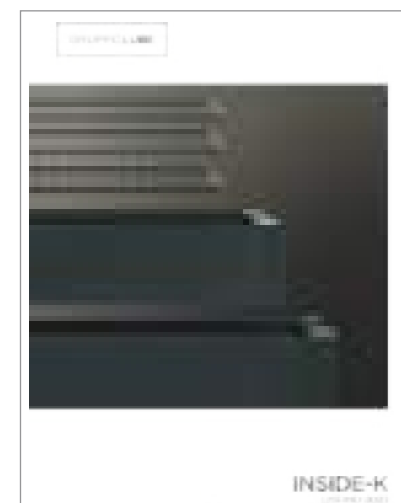
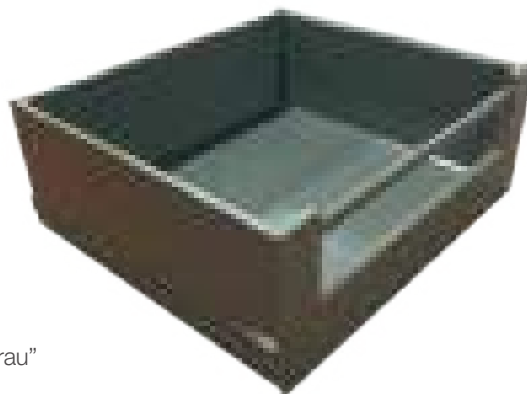





# COLONNE "NOOK" P. 70,4 CON ANTE A SCOMPARSA

"NOOK" COLUMNS D. 70,4 WITH INWARDS DOORS

**i** Le colonne "Nook" con ante a scomparsa, consentono di inserire all'interno forno, frigo, piano estraibile "SKIP-N" e cassetti  
"Nook" columns with pull-out doors allow to insert oven, fridge, extractable work-top "SKIP-N" and drawer on the inside

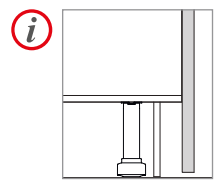

**i** Le colonne "Nook" sono disponibili anche nella versione con ANTE FINO A TERRA.  
"Nook" columns are available also in the version with DOOR DOWN TO GROUND.



# COLONNE SINGOLE L. 69,1 - L.104,6 - L.134,6

SINGLE COLUMNS L. 69,1 - L.104,6 - L.134,6

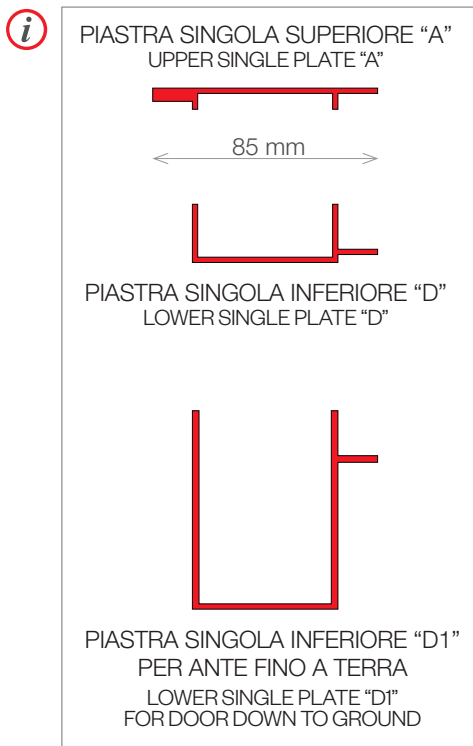
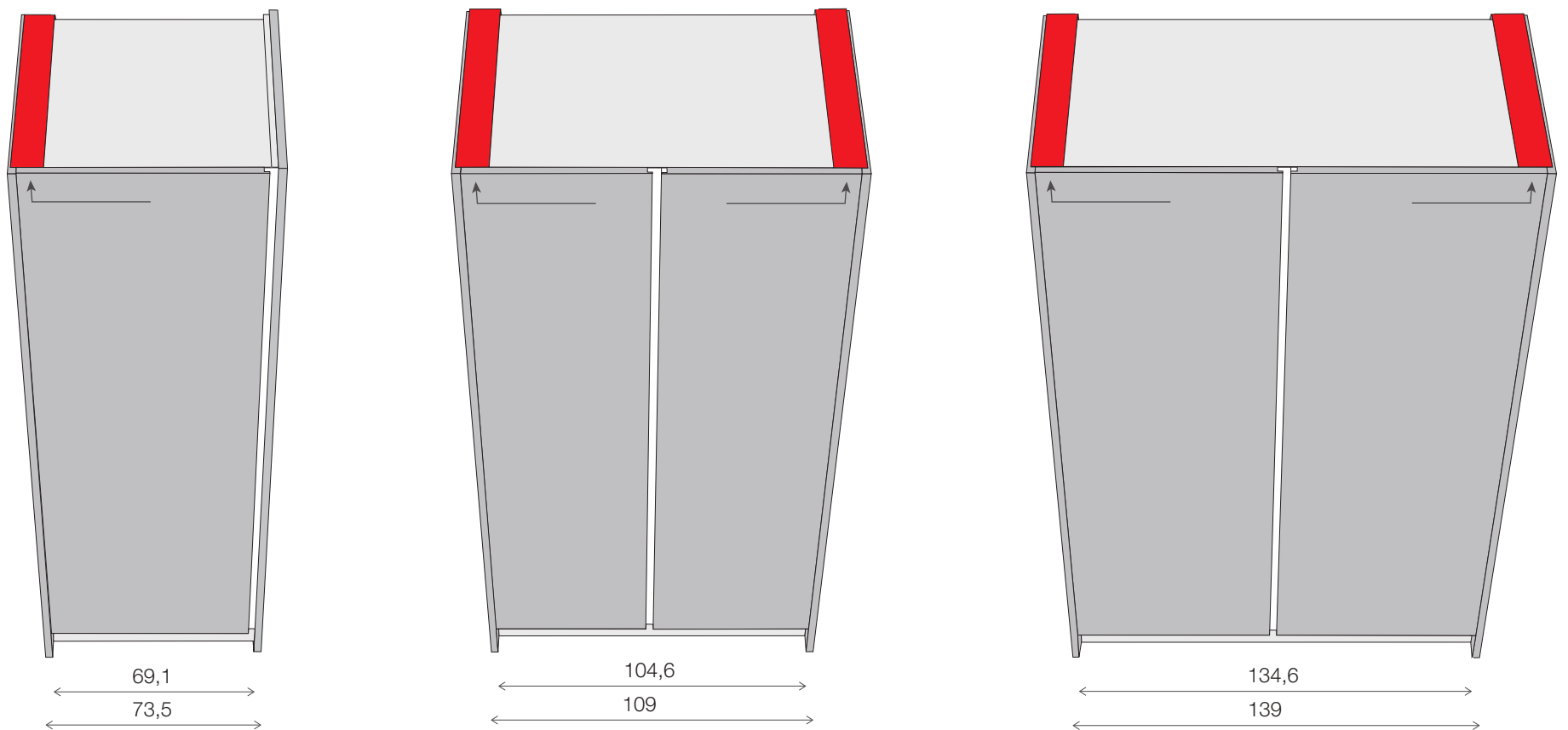

## CONSULTA EXTRANET:

- CONSULT ON EXTRANET:
- Istruzioni di montaggio
  - Istruzioni regolazione ante
  - Video sequenza di montaggio
  - Assembly instructions
  - Doors adjustment instructions
  - Assembly sequence video



**!** Le piastre singole "A+D" o "A+D1" per ante fino a terra, sono sempre obbligatorie nel lato con ante rientrante in presenza di un fianco fino a terra terminale e permettono la scomparsa nella sede laterale di un'unica ante.  
The single plates "A+D" or "A+D1" for doors down to ground, are always obligatory in the side with retractable door in the presence of a terminal side panel down to ground and allows the disappearance in the side seat of a single door.

**!** È sempre obbligatorio inserire un fianco fino a terra terminale nel lato con ante rientrante, sia esso terminale a vista che a parete.  
It is always obligatory to insert a ground terminal side panel in the side with retractable door, whether it is an exposed or wall-mounted panel.

**!** Le colonne Nook sono disponibili esclusivamente con presa maniglia integrata "A+B", con maniglia "FUSION" o con maniglia incassata "940".  
Nook columns are available exclusively with integrated handle grip "A+B", with "FUSION" handle or with "940" built-in handle.

## COMPOSIZIONI COLONNE "NOOK"

"NOOK" COLUMNS COMPOSITIONS

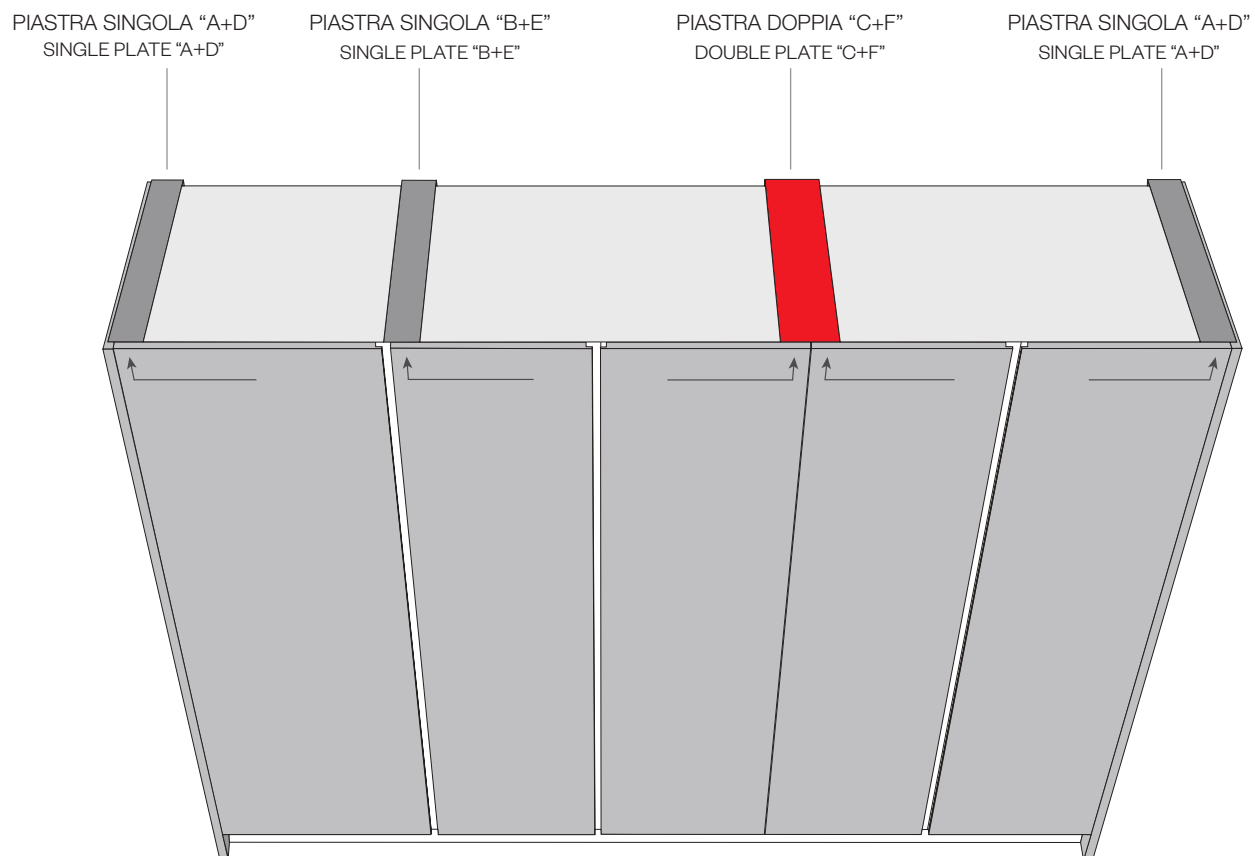
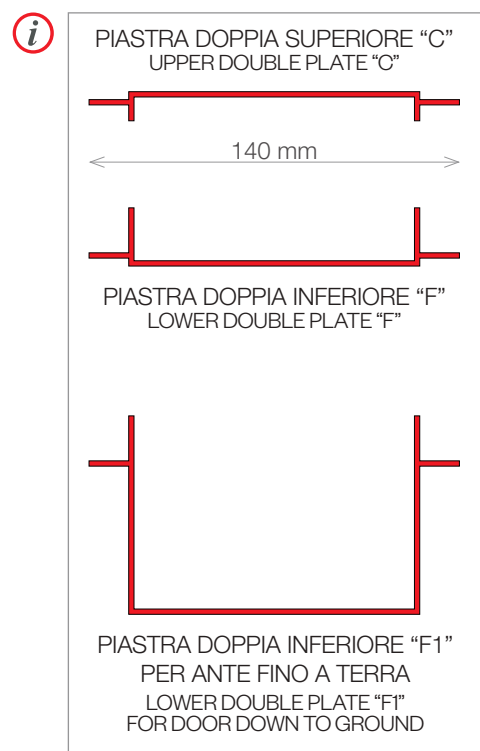

**!** Le piastre doppie "C+F" o "C+F1" per ante fino a terra, sono obbligatorie tra due colonne in caso di accosto di due ante a scomparsa che rientrano nella stessa sede laterale.  
The double plates "C+F" or "C+F1" for doors down to ground are obligatory between two columns in the case of two retractable doors that fit together in the same lateral seat.

## COMPOSIZIONI COLONNE "NOOK" CON COLONNE STANDARD

"NOOK" COLUMNS COMPOSITIONS WITH STANDARD COLUMNS

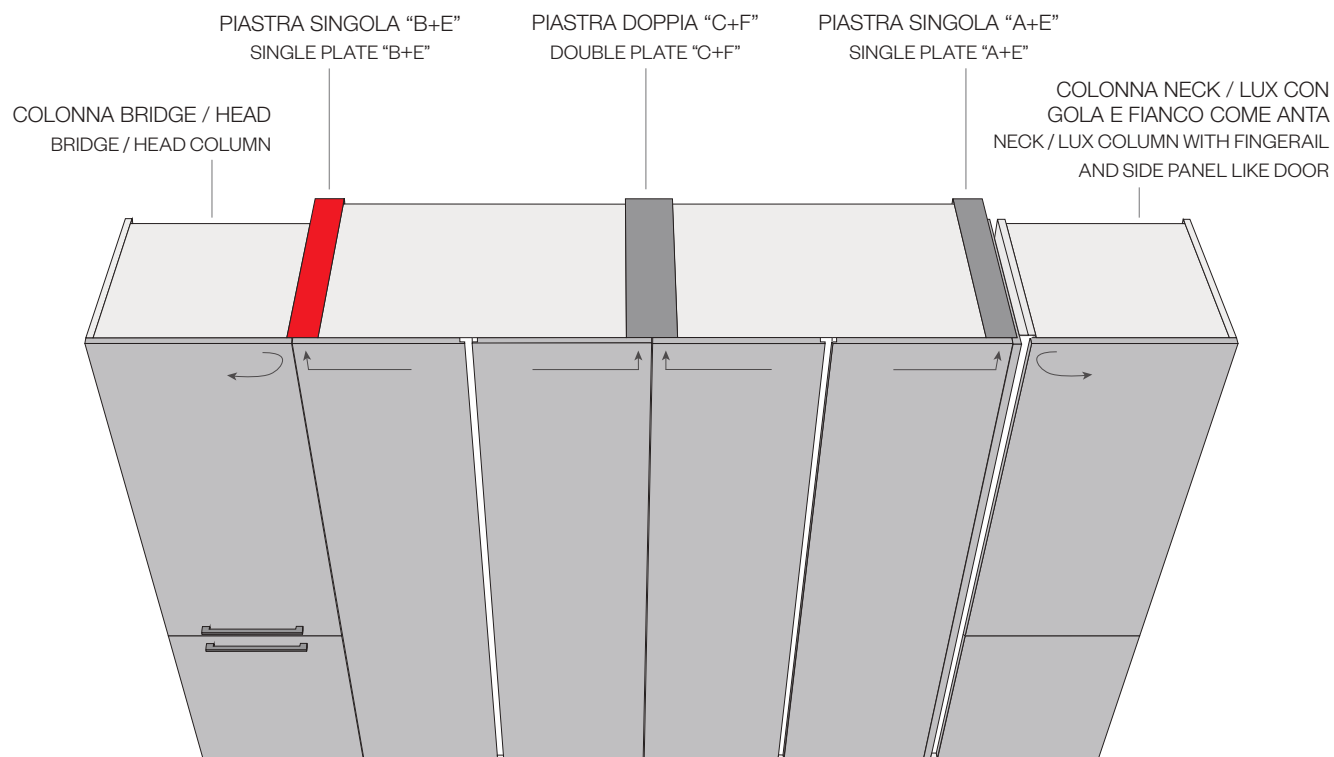
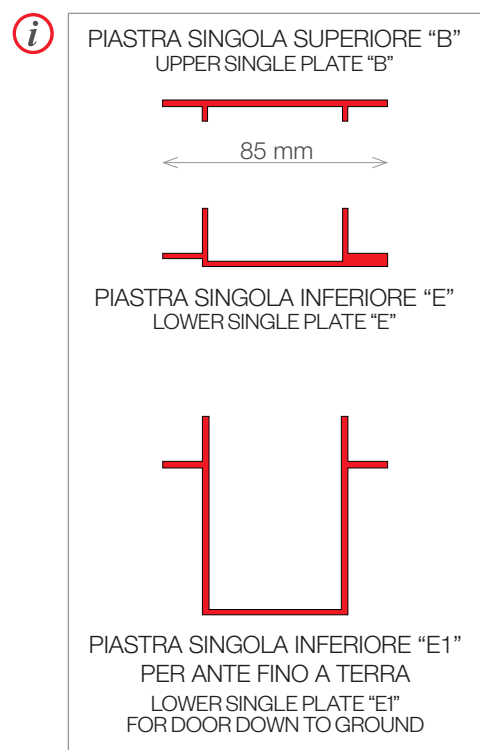

**!** Le piastre singole "B+E" o "B+E1" per ante fino a terra, sono obbligatorie tra due colonne nel lato con anta rientrante e permettono la scomparsa nella sede laterale di un'unica anta.  
The single plates "B+E" or "B+E1" for doors down to ground, are obligatory between two columns in the side with retractable door and allows the disappearance in the side seat of a single door.

**!** Non affiancare a colonne standard se dal lato in cui la porta rientra si trova la gola verticale. É obbligatorio inserire la gola più il fianco come anta.  
Do not join standard columns if the vertical finger rail is on the side where the door retracts. It is obligatory to insert the finger rail plus the side panel like door.

**i** Il piano estraibile "SKIP-N" è disponibile nella versione inox o in laminato nella finitura oak cognac.

The extractable work-top "SKIP-N" it's available in stainless steel version or laminate oak cognac finish.



## COMPOSIZIONI COLONNE "NOOK" CON SOPRACOLONNE

"NOOK" COLUMNS COMPOSITIONS WITH ABOVE-COLUMNS ELEMENTS

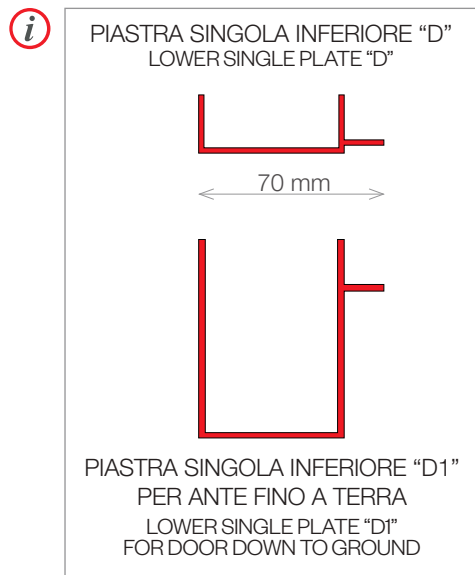

**!** In presenza degli elementi sopra-colonne NOOK, non vanno installate le piastre singole e doppie superiori. Inserire solo le piastre singole inferiori "D" o "D1" e doppie inferiori "F" o "F1" e i fianchi terminali dell'altezza giusta in base ai moduli superiori.

With NOOK above-columns elements, the upper single and double plates must not be installed. Insert only the lower single plates "D" or "D1" and the lower double plates "F" or "F1" and the end side panels of the right height according to the upper modules.

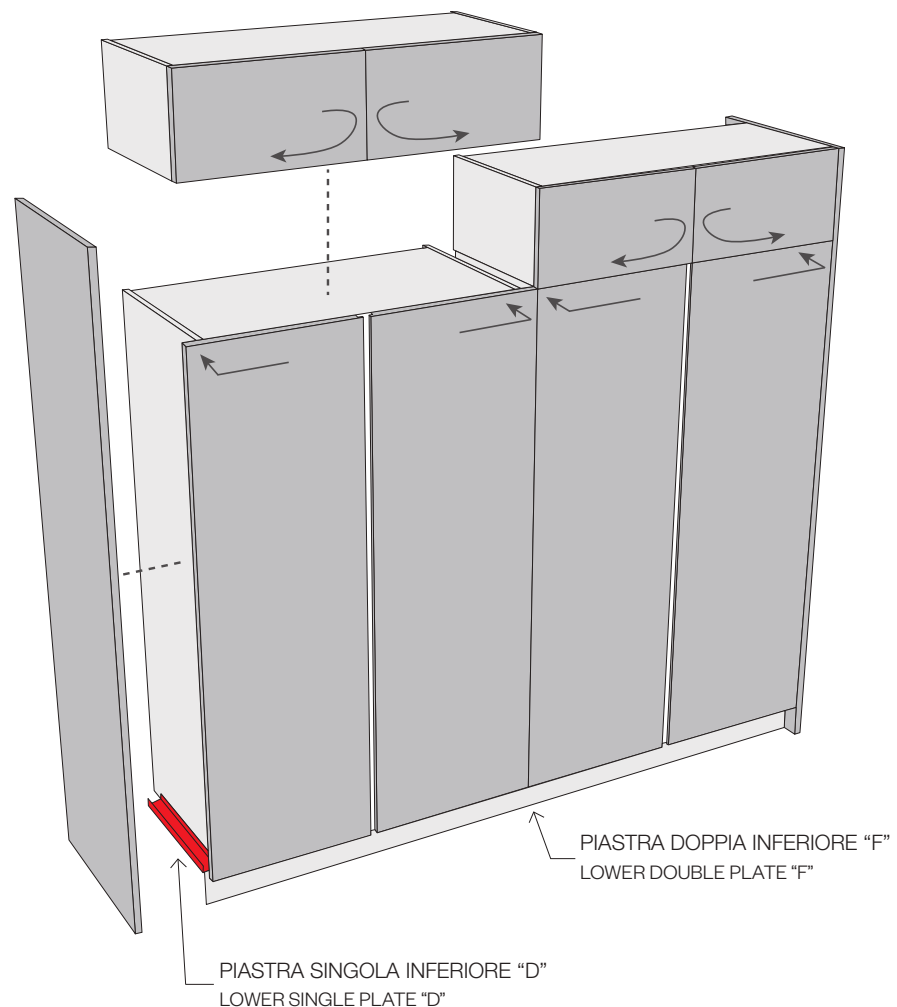



**COLORI ANTE CHIUSE E PANNELLI FISSI FRONTALE E LATERALE**  
COLOURS FOR DOORS AND FIXED FRONT LATERAL PANELS



**per colori vedi pag.32-45**  
for colours see page 32-45

**ANTE VETRO**  
GLASS DOORS



**per colori vedi pag.46-51**  
for colours see page 46-51

**COLORI STRUTTURA INTERNA IN NOBILITATO**  
COLOURS FOR INTERNAL MELAMINE-COATED STRUCTURE

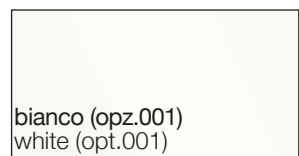

bianco (opz.001)  
white (opt.001)

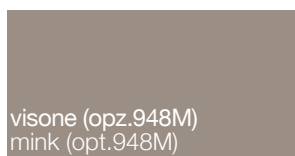

visone (opz.948M)  
mink (opt.948M)

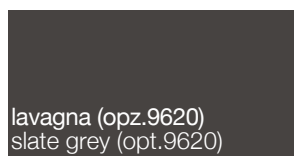

lavagna (opz.9620)  
slate grey (opt.9620)

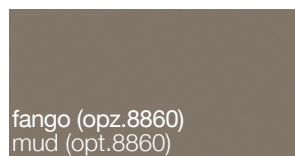

fango (opz.8860)  
mud (opt.8860)

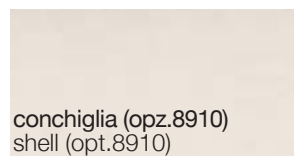



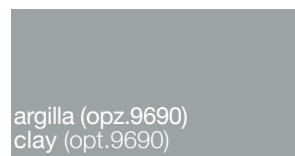

conchiglia (opz.8910)  
shell (opt.8910)

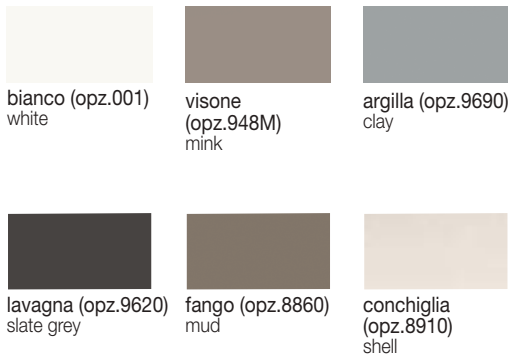

argilla (opz.9690)  
clay (opt.9690)

# MENSOLE

## SHELVES

	COD.			COD.			
<b>mensola sp. 3,8 in nobilitato colori strutture</b> <b>L max cm 400</b> melamine shelf Th. 3.8, colours carcasses max. length 400 cm    Colori strutture Structure colours  				<b>mensola sp. 3,8 mathera, L max cm 300</b> <b>finiture come ante vedi pag.40-41</b> mathera shelf Th. 3.8, max. length 300 cm same finishes as doors see page.40-41  			
					P 31 091523 P 61 091560		
<b>mensola sp. 3,8 wood, L max cm 300</b> <b>finiture come ante vedi pag.42-43</b> wood shelf Th. 3.8, max. length 300 cm same finishes as doors see page.42-43  				<b>mensola sp. 3,8 in melaminico, L max cm 275</b> <b>finiture come ante vedi pag.32-35</b> melamine shelf Th. 3.8, max. length 275 cm same finishes as doors see page.32-35  			
					P 31 091723W P 61 091729W		
<b>mensola sp. 3,8 in melaminico, L max cm 275</b> <b>finiture come ante vedi pag.32-35</b> melamine shelf Th. 3.8, max. length 275 cm same finishes as doors see page.32-35  				<b>mensola sp. 3,8 pet, L max cm 300</b> <b>finiture come ante vedi pag.44</b> pet shelf Th. 3.8, max. length 300 cm same finishes as doors see page.44  			
					P 31 091523 P 61 091560	P 31 091523 P 61 091560	
<b>mensola laccate sp. 3,8</b> <b>finiture come ante vedi pag.36-37</b> <b>L max cm 400</b> lacquered shelf Th. 3.8 same finishes as doors see page.36-37 max. length 400 cm  				<b>reggimensola a scomparsa</b> fully integrated shelf bracket  			
	OPACHE matt						
	P 31	091733					
	P 61	091736					
	LUCIDE glossy						
P 31	091733						
P 61	091736						
				cadauno each	08610400		

# MENSOLE IN LAMIERA VERNICIATA CON SCHIENALE NEI COLORI COME ANTE

PAINTED STEEL SHELVES WITH BACK PANEL SAME COLOURS AS DOORS

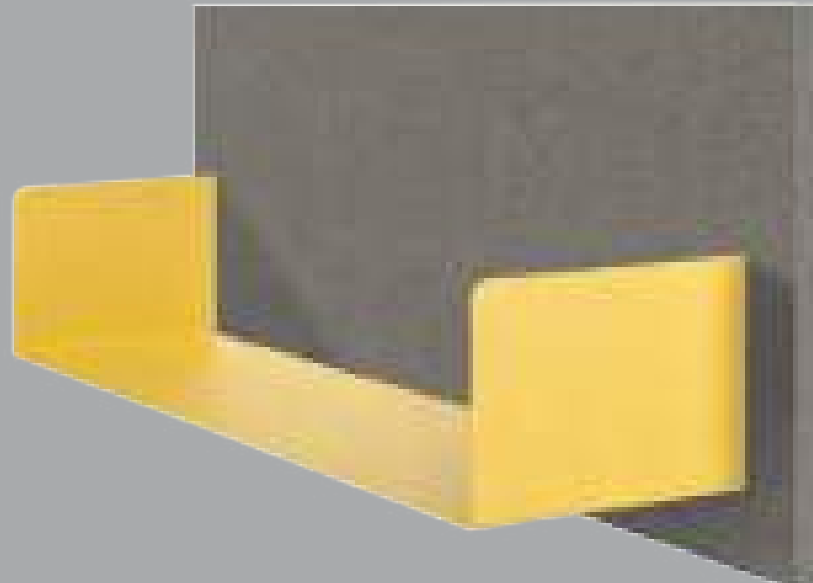
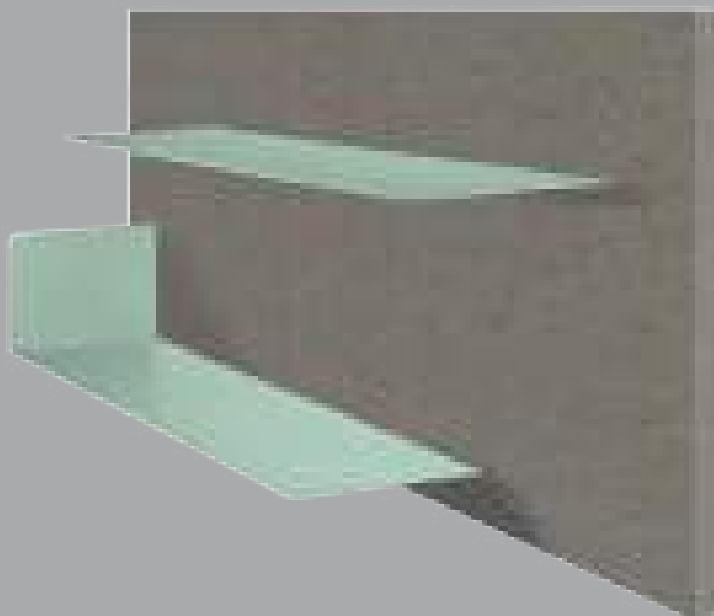

finiture mensole in lamiera verniciata a polvere opache  
steel shelves matt powder coated

## COLORI FREDDI OPACHI SOFT SOFT MATT COLD COLOURS

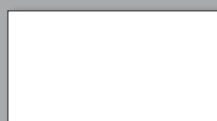

bianco assoluto (opz.740S)  
absolute white

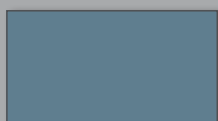

azzurro ottanio (opz.8385)  
teal blue

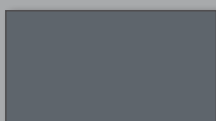

grigio bromo (opz.9533)  
bromine grey

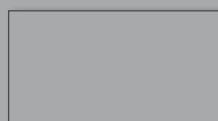

grigio traffico (opz.9511)  
traffic grey



silver dark (opz.9507)  
dark silver

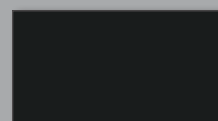

nero (opz.7892)  
black

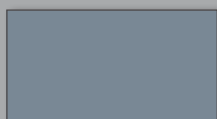

azzurro nube (opz.8379)  
cloud blue

## COLORI CALDI OPACHI SOFT SOFT MATT HOT COLOURS

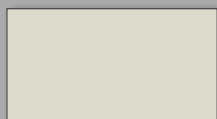

lino (opz.9513)  
linen

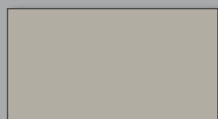

grigio kenya (opz.9501)  
kenya grey

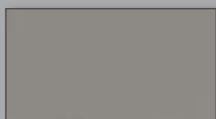

grigio selce (opz.SEL)  
flint grey

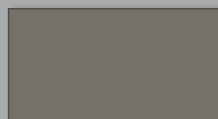

grigio piombo (opz.9537)  
lead grey

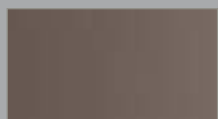

terra d'ombra (opz.955T)  
shadow earth

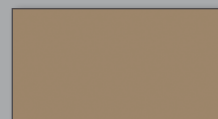

ottone (opz.7761)  
brass

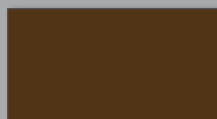

umber (opz.955U)  
copper

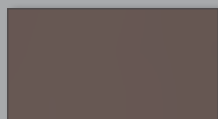

cuoio (opz.8897)  
leather

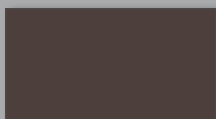

ghisa (opz.9509)  
cast iron

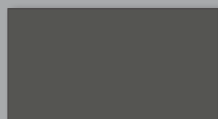

fumo (opz.9531)  
smoke

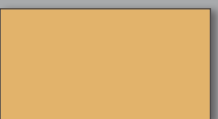

giallo digione (opz.8257)  
digione yellow

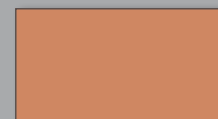

cotto (opz.8887)  
cooked

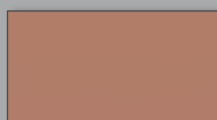

rame (opz.8167)  
copper

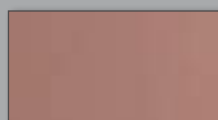

rame brunito (opz.8168)  
burnished copper

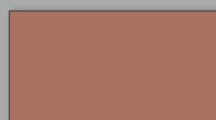

rosso persia (opz.8165)  
persia red

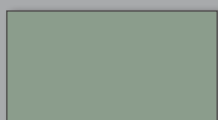

verde celadon (opz.8485)  
celadon green

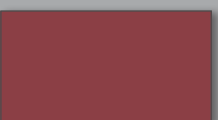

rosso velvet (opz.8169)  
velvet red

# MOBILI LIVING “PLAN” COMPONENTI

“PLAN” LIVING MODULAR FURNITURE

---





# VIVI IL LIVING

LIVE THE LIVING

Con i nuovi pensili più profondi  
è facilissimo creare composizioni living  
adatte ad ogni spazio.

With new more deep wall units,  
it's easy to create lively  
furnishing compositions.

