

LUNA



IL TAGLIO MODERNO DELLA CUCINA THE MODERN CUT OF THE KITCHEN

Soluzioni arredative dinamiche, che rispecchiano lo stile moderno del modello Luna, pensate per incontrare nuovi modi di vivere lo spazio cucina.

La presa integrata nell'anta forma un disegno modulabile che caratterizza i frontali della cucina con eleganza.

Le numerose nuance neutre della collezione trovano forma in grandi campiture che si affiancano a superfici pregiate in legno impiallacciato.

Dynamic furnishing solutions that reflect the modern style of the Luna model, designed to create new ways of experiencing the kitchen area.

The handle integrated into the door forms a modular design that elegantly characterises the kitchen's front panels.

The numerous neutral nuances in the collection find form in large fields that are combined with precious surfaces in veneered wood.

SP. 22 MM

CARATTERISTICHE TECNICHE

ANTE E FRONTALI CASSETTI

anta sp.22 mm impiallacciata **rovere laccato a poro aperto** fiamma orizzontale nei colori: rovere bianco (opz.5429), rovere grigio reale (opz.5432), rovere carbon (opz.5434), rovere grigio traffico (opz.5431)

anta sp.22 mm impiallacciata **rovere spazzolata materica** fiamma orizzontale nei colori: rovere lino (opz.5430), rovere moresco (opz.5433), rovere natur (opz.5440)

anta sp.22 mm impiallacciata **poro semiaperto** fiamma orizzontale nel colore: noce canaletto (opz.1331)

ANTE VETRO

telaio impiallacciato sp.22 mm nei colori come ante, vetro satinato bianco e bronzato sp.4 mm

MANIGLIE

la presa maniglia è inclusa sull'anta con profilo tipo **"A" - "AS" - "B" - "D" - "DS" - "E"** (vedi pag.16-21)

STRUTTURE

ANTE: rovere bianco, rovere grigio traffico

di serie : nobilitato bianco (opz.001) schiena e ripiano bianco (opz.001)

ANTA: rovere carbon

di serie : nobilitato lavagna (opz.9620) schiena e ripiano lavagna (opz.9620)

ANTE: rovere grigio reale, rovere lino

di serie : nobilitato visone (opz.948M) schiena e ripiano visone (opz.948M)

ANTE: rovere moresco, rovere natur, noce canaletto

di serie : nobilitato fango (opz.8860) schiena e ripiano fango (opz.8860)



MENSOLE

vedi pag.22

ZOCCOLI

vedi pag.23



TH. 22 MM

TECHNICAL FEATURES**DOORS AND
DRAWER FRONTS**

22 mm thick veneered door in **open pore lacquer oak** with horizontal grain in the following colours: white oak (opt.5429), royal grey oak (opt.5432), carbon oak (opt.5434), traffic grey oak (opt.5431)

22 mm thick veneered door in **textured brushed oak** with horizontal grain in the following colours: linen oak (opt.5430), moorish oak (opt.5433), natur oak (opt.5440)

22 mm thick veneered door **semi-open pore** with horizontal grain in the following colours: canaletto walnut (opt.1331)

GLASS DOORS

22 mm thick veneered frame to match doors, satin white and bronze glass 4 mm thick

HANDLES

the handle grip is included on doors with profile types **"A" - "AS" - "B" - "D" - "DS" - "E"** (see page 16-21)

STRUCTURES

DOORS: white oak, traffic grey oak

as standard: melamine-coated white (opt.001) white back panel and shelf (opt.001)

DOOR: carbon oak

as standard: melamine-coated slate grey (opt.9620) slate grey back panel and shelf (opt.9620)

DOORS: royal grey oak, linen oak

as standard: melamine-coated mink (opt.948M) mink back panel and shelf (opt.948M)

DOORS: moorish oak, natur oak, canaletto walnut

as standard: melamine-coated mud (opt.8860) mud back panel and shelf (opt.8860)

SHELVES

see page 22

PLINTHS

see page 23

SP. 22 MM TH. 22 MM

ante rovere laccato a poro aperto door in open-pore lacquered oak



rovere bianco (opz.5429)
fiamma orizzontale
white oak (opt.5429),
horizontal grain



rovere grigio reale (opz.5432)
fiamma orizzontale
royal grey oak (opt.5432),
horizontal grain



rovere grigio traffico (opz.5431)
fiamma orizzontale
traffic grey oak (opt.5431),
horizontal grain



rovere carbon (opz.5434)
fiamma orizzontale
carbon oak (opt.5434),
horizontal grain

ante rovere spazzolate materiche brushed door in oak textured finish



rovere lino (opz.5430)
fiamma orizzontale
linen oak (opt.5430),
horizontal grain



rovere moresco (opz.5433)
fiamma orizzontale
moorish oak (opt.5433),
horizontal grain



rovere natur (opz.5440)
fiamma orizzontale
natur oak (opt.5440),
horizontal grain

ante vetro impiallacciate glass veneered doors



telaio rovere natur con
vetro satinato (opz.5440B)
natur oak frame with
satin glass (opt.5440B)



telaio rovere natur con
vetro bronzo (opz.5440Z)
natur oak frame with
bronze glass (opt.5440Z)

N.B.: disponibile in tutte le finiture impiallacciate
Note: available in all veneered finishes

cod. **311**

Impiallacciato Veneered

SP. 22 MM TH. 22 MM

anta poro semiaperto semi-open pore door



noce canaletto (opt.1331)
fiamma orizzontale
canaletto walnut (opt.1331),
horizontal grain

anta vetro impiallacciata glass veneered door



telaio noce canaletto con
vetro satinato (opt.1331B)
canaletto walnut frame
with satin glass (opt.1331B)



telaio noce canaletto con
vetro bronzo (opt.1331Z)
canaletto walnut frame
with bronze glass (opt.1331Z)

disegni tecnici technical drawings

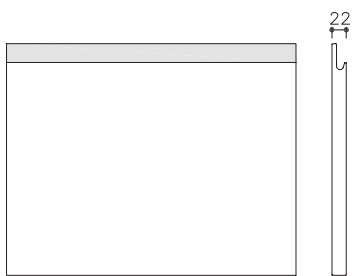

anta chiusa con presa maniglia tipo "A"
door with type "A" handle grip



anta chiusa con presa maniglia tipo "B"
door with type "B" handle grip

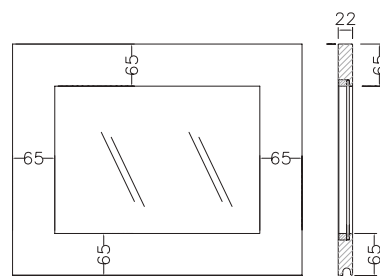

anta vetro con presa maniglia tipo "B"
glass door with type "B" handle grip

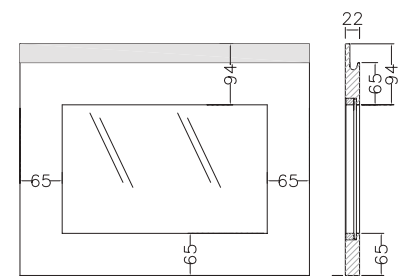

cestone vetro con presa maniglia tipo "A"
glass deep drawer with type "A"
handle grip

SP. 22 MM TH. 22 MM

CARATTERISTICHE TECNICHE

ANTE E FRONTALI CASSETTI

anta sp.22 mm in mdf con fondo cemento laccata finitura pigmentata acrilica antigraffio nei colori opachi: bianco (opz.LM21), sabbia (opz.LM22), calce (opz.LM23), grigio Londra (opz.LM24), piombo (opz.LM25)

ANTE VETRO

telaio sp.22 mm in mdf con fondo cemento, laccato nei colori come ante, vetro satinato bianco e bronzato sp.4 mm

MANIGLIE

la presa maniglia è inclusa sull'anta con profilo tipo "A" - "AS" - "B" - "D" - "DS" - "E" (vedi pag.16-21)

STRUTTURE

ANTA: bianco, calce
di serie : nobilitato bianco (opz.001) schiena e ripiano bianco (opz.001)
ANTE: grigio Londra, piombo
di serie : nobilitato lavagna (opz.9620) schiena e ripiano lavagna (opz.9620)
ANTA: sabbia
di serie : nobilitato visone (opz.948M) schiena e ripiano visone (opz.948M)



MENSOLE

vedi pag.22

ZOCCOLI

vedi pag.23

TECHNICAL FEATURES

DOORS AND DRAWER FRONTS

22 mm thick in mdf lacquered door with cement in scratch-resistant pigmented acrylic finish in the following matt colours: white (opt.LM21), sand (opt.LM22), lime (opt.LM23), london grey (opt.LM24), lead (opt.LM25)

GLASS DOORS

22 mm thick in mdf lacquer frame to match doors, satin white and bronze glass 4 mm thick

HANDLES

the handle grip is included on doors with profile types "A" - "AS" - "B" - "D" - "DS" - "E" (see page 16-21)

STRUCTURES

DOOR: white, lime
as standard: melamine-coated white (opt.001) white back panel and shelf (opt.001)
DOORS: london grey, lead
as standard: melamine-coated slate grey (opt.9620) slate grey back panel and shelf (opt.9620)
DOOR: sand
as standard: melamine-coated mink (opt.948M) mink back panel and shelf (opt.948M)

SHELVES

see page 22

PLINTHS

see page 23



cod. **312**

Malta Laccato Opaco Matt Lacquered Mortar Finish

SP. 22 MM TH. 22 MM

ante laccate con fondo cemento

lacquered doors with cement surface



bianco (opz.LM21)
white (opt.LM21)



sabbia (opz.LM22)
sand (opt.LM22)



calce (opz.LM23)
lime (opt.LM23)



grigio Londra (opz.LM24)
london grey (opt.LM24)



piombo (opz.LM25)
lead (opt.LM25)



particolare finitura
finishing detail

ante vetro laccate con fondo cemento

lacquered glass doors with cement surface



telaio grigio Londra con
vetro satinato (opz.LM24B)
london grey frame
with satin glass (opt.LM24B)



telaio grigio Londra con
vetro bronzo (opz.LM24Z)
london grey frame
with bronze glass (opt.LM24Z)

disegni tecnici technical drawings



anta chiusa con presa maniglia tipo "A"
door with type "A" handle grip

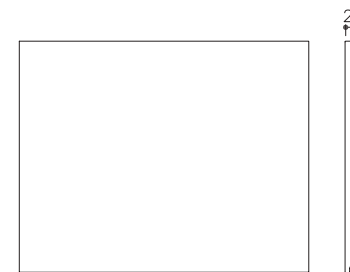

anta chiusa con presa maniglia tipo "B"
door with type "B" handle grip

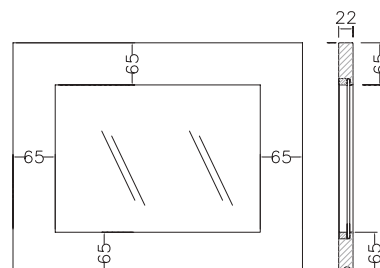

anta vetro con presa maniglia tipo "B"
glass door with type "B" handle grip

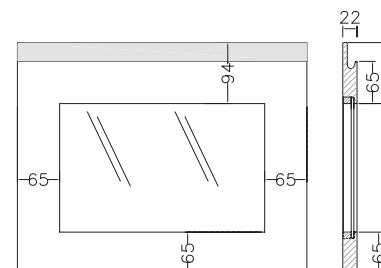

cestone vetro con presa maniglia tipo "A"
glass deep drawer with type "A"
handle grip

MALTA
LACCATO OPACO
MATT LACQUERED
MORTAR FINISH

SP. 22 MM TH. 22 MM

CARATTERISTICHE TECNICHE

ANTE E FRONTALI CASSETTI

anta sp.22 mm in mdf laccata **finitura opaca soft nei colori :**

 [CLICCA QUI PER LA GAMMA COLORI DISPONIBILI](#)

 [CLICK HERE FOR THE RANGE OF AVAILABLE COLORS](#)

ANTE VETRO

telaio laccato opaco sp.22 mm nei colori come ante, vetro satinato bianco e bronzato sp.4 mm

MANIGLIE

la presa maniglia è inclusa sull'anta con profilo tipo **"A" - "AS" - "B" - "D" - "DS" - "E"** (vedi pag.16-21)

STRUTTURE

di serie: nobilitato bianco (opz.001) schiena e ripiano bianco (opz.001)

a richiesta: nobilitato visone (opz.948M) schiena e ripiano visone (opz.948M)
nobilitato lavagna (opz.9620) schiena e ripiano lavagna (opz.9620)
nobilitato devalè finitura grafis (opz.796) schiena e ripiano bianco (opz.001)
nobilitato perla d'oriente (opz.940) schiena e ripiano bianco (opz.001)
nobilitato fango (opz.8860) schiena e ripiano fango (opz.8860)



MENSOLE

[vedi pag.22](#)

ZOCCOLI

[vedi pag.23](#)

TECHNICAL FEATURES

DOORS AND DRAWER FRONTS

door 22 mm thick in lacquered mdf **soft matt finish in the following colours:**

GLASS DOORS

22 mm thick matt lacquered frame to match doors, satin white and bronze glass 4 mm thick

HANDLES

the handle grip is included on doors with profile types **"A" - "AS" - "B" - "D" - "DS" - "E"** (see page 16-21)

STRUCTURES

as standard: melamine-coated white (code 001), white back panel and shelf (code 001)

on request: melamine-coated mink (opt.948M), mink back panel and shelf (opt.948M)
melamine-coated slate grey (opt.9620), slate grey back panel and shelf (opt.9620)
melamine-coated devalè with grafis finish (opt.796), white back panel and shelf (opt.001)
melamine-coated oriental pearl (opt.940), white back panel and shelf (opt.001)
melamine-coated mud (opt. 8860), mud back panel and shelf (opt.8860)

SHELVES

[see page 22](#)

PLINTHS

[see page 23](#)

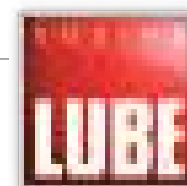

cod. **314**

Laccato Lucido Spazzolato Brushed Glossy Lacquered

SP. 22 MM TH. 22 MM

CARATTERISTICHE TECNICHE

ANTE E FRONTALI
CASSETTI

anta sp.22 mm in mdf laccata **finitura lucida spazzolata nei colori:**

 [CLICCA QUI PER LA GAMMA COLORI DISPONIBILI](#)

 [CLICK HERE FOR THE RANGE OF AVAILABLE COLORS](#)

ANTE VETRO

telaio laccato lucido spazzolato sp.22 mm nei colori come ante, vetro satinato bianco e bronzato sp.4 mm

MANIGLIE

la presa maniglia è inclusa sull'anta con profilo tipo "A" - "AS" - "B" - "D" - "DS" - "E" (vedi pag.16-21)

STRUTTURE

di serie: nobilitato bianco (opz.001) schiena e ripiano bianco (opz.001)

a richiesta: nobilitato visone (opz.948M) schiena e ripiano visone (opz.948M)
nobilitato lavagna (opz.9620) schiena e ripiano lavagna (opz.9620)
nobilitato devalè finitura grafis (opz.796) schiena e ripiano bianco (opz.001)
nobilitato perla d'oriente (opz.940) schiena e ripiano bianco (opz.001)
nobilitato fango (opz.8860) schiena e ripiano fango (opz.8860)



MENSOLE

[vedi pag.22](#)

ZOCCOLI

[vedi pag.23](#)

TECHNICAL FEATURES

DOORS AND
DRAWER FRONTS

door 22 mm thick in lacquered mdf **brushed glossy finish in the following colours:**

GLASS DOORS

22 mm thick brushed glossy lacquered frame to match doors, satin white and bronze glass 4 mm thick

HANDLES

the handle grip is included on doors with profile types "A" - "AS" - "B" - "D" - "DS" - "E" (see page 16-21)

STRUCTURES

as standard: melamine-coated white (code 001), white back panel and shelf (code 001)

on request: melamine-coated mink (opt.948M), mink back panel and shelf (opt.948M)
melamine-coated slate grey (opt.9620), slate grey back panel and shelf (opt.9620)
melamine-coated devalè with grafis finish (opt.796), white back panel and shelf (opt.001)
melamine-coated oriental pearl (opt.940), white back panel and shelf (opt.001)
melamine-coated mud (opt. 8860), mud back panel and shelf (opt.8860)

SHELVES

[see page 22](#)

PLINTHS

[see page 23](#)

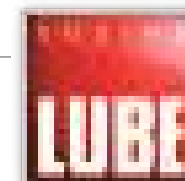

cod. **313**

SP. 22 MM TH. 22 MM

Laccato Opaco Matt Lacquered

ante laccate opache

matt lacquered doors



ante vetro laccate opache

matt lacquered glass doors



N.B.: disponibile in tutte le finiture
laccate opache

Note: available in all matt lacquered
finishes

cod. **314**

Laccato Lucido Spazzolato Brushed Glossy Lacquered

SP. 22 MM TH. 22 MM

ante laccate lucide spazzolate

brushed glossy lacquered doors



ante vetro laccate lucide spazzolate

brushed glossy lacquered glass doors



telaio con
vetro satinato (opz.8908B)
beaver frame with
satin glass (opt.8908B)



telaio con vetro bronzo
(opz.8908Z) beaver
frame with bronze glass
(opt.8908Z)

N.B.: disponibile in tutte le finiture
laccate lucide spazzolate

Note: available in all brushed
glossy lacquered finishes

Tipologie Profili Profiles Types

TIPO A PRESA ORIZZONTALE
per basi, cassetti, cestoni e ante inferiori colonne

TYPE A HORIZONTAL GRIP
for base units, drawers, deep drawers and lower door columns

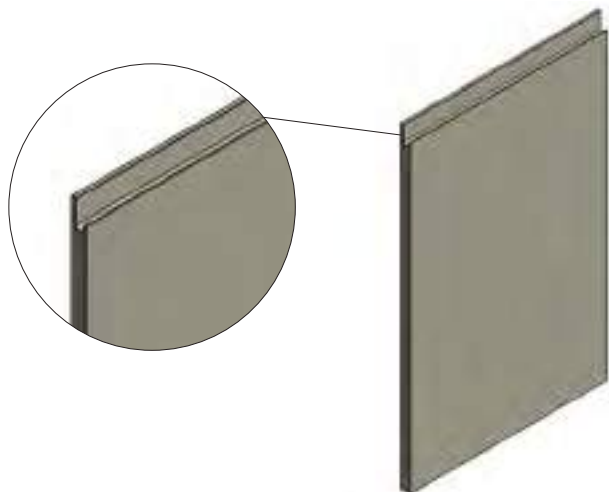

TIPO AS PRESA ORIZZONTALE SAGOMATA
per basi, cassetti, cestoni e ante inferiori colonne

TYPE AS HORIZONTAL SHAPED GRIP
for base units, drawers, deep drawers and lower door columns

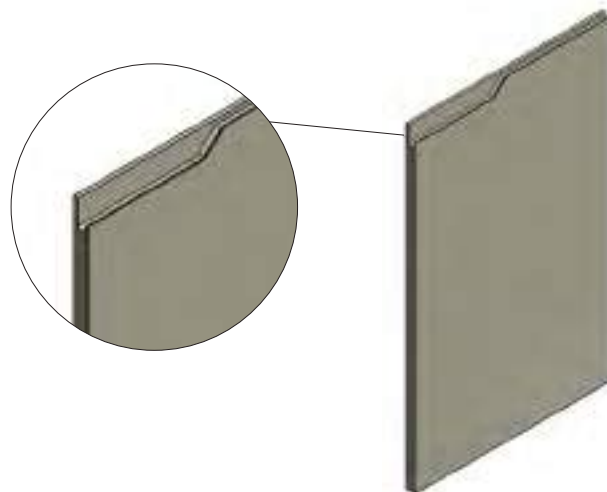

TIPO B PRESA ORIZZONTALE RIDOTTA
per pensili e ante superiori delle colonne

TYPE B REDUCED HORIZONTAL GRIP
for wall units and upper doors columns

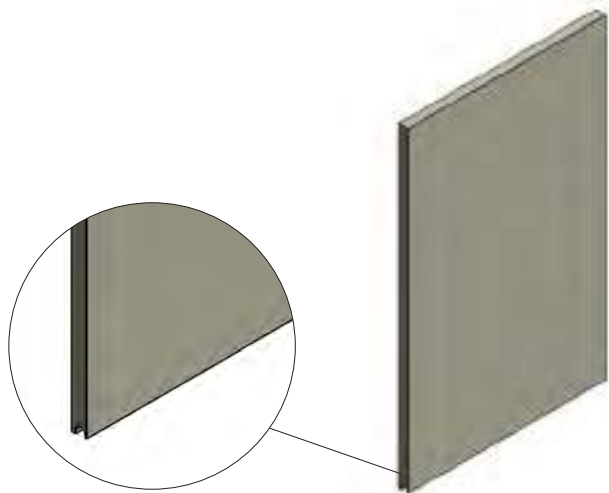

TIPO C ANTA SENZA PRESA
per base terminale e cabina ripostiglio

TYPE C WITHOUT GRIP DOOR
for base end unit and closet columns

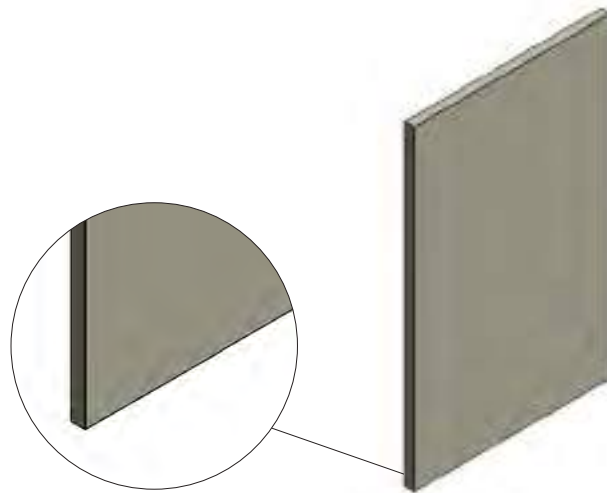

TIPO D PRESA VERTICALE
per colonne anta unica

TYPE D VERTICAL GRIP
for single door columns

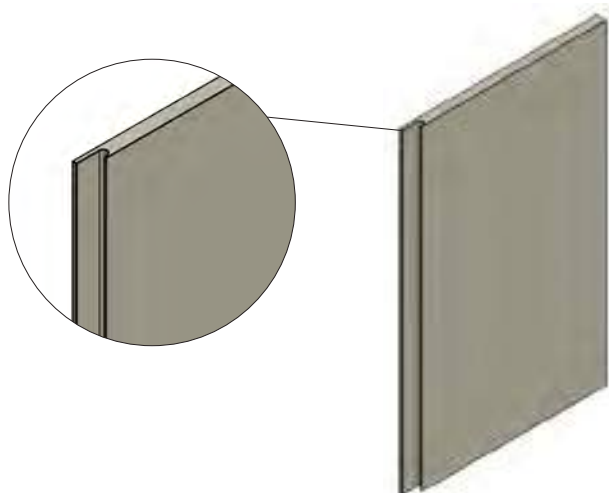

TIPO DS PRESA VERTICALE SAGOMATA
per ante inferiori delle colonne e colonne anta unica

TYPE DS VERTICAL SHAPED GRIP
for lower doors columns and single door columns

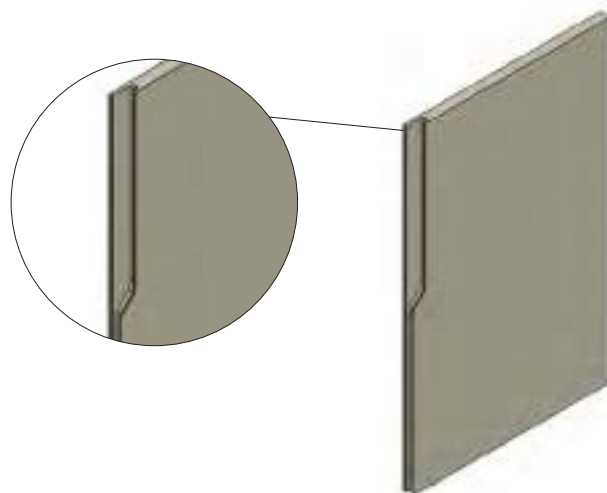

Tipologie Profili Profiles Types

TIPO E PRESA VERTICALE RIDOTTA
per colonne e ante rientranti "NOOK"

TYPE E REDUCED VERTICAL GRIP
for columns and "NOOK" inwards doors

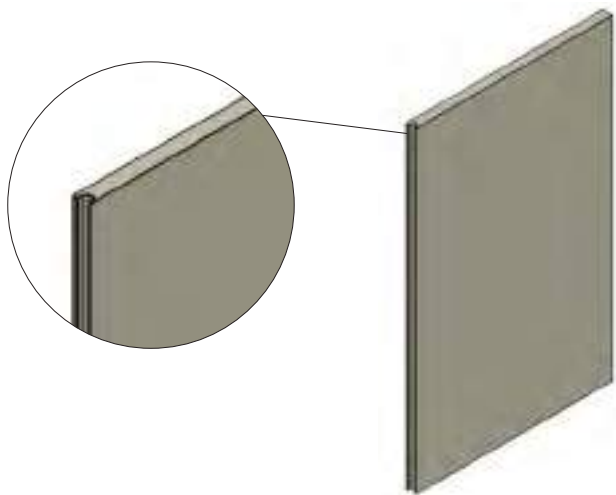

Combinazioni Profili Profiles Combinations

TIPO C+B ANTA SUPERIORE SENZA PRESA
ANTA INFERIORE PRESA ORIZZONTALE RIDOTTA
per pensili apertura a pacchetto

TYPE C+B UPPER DOOR WITHOUT HANDLE
LOWER DOOR WITH REDUCED HORIZONTAL GRIP
for wall units with folding opening

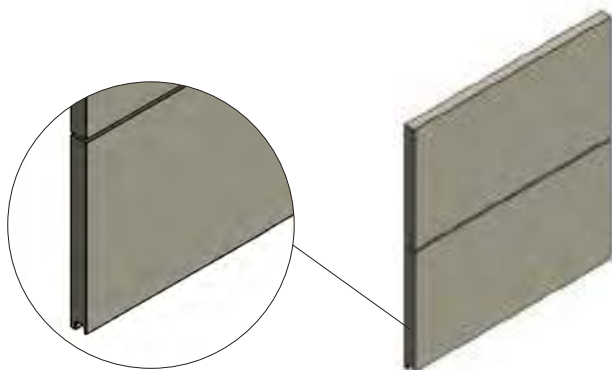

TIPO B+A ANTA SUPERIORE PRESA RIDOTTA
ANTA INFERIORE PRESA ORIZZONTALE
per colonne 2 ante

TYPE B+A UPPER DOOR WITH REDUCED GRIP
LOWER DOOR WITH HORIZONTAL GRIP
for columns with 2 doors

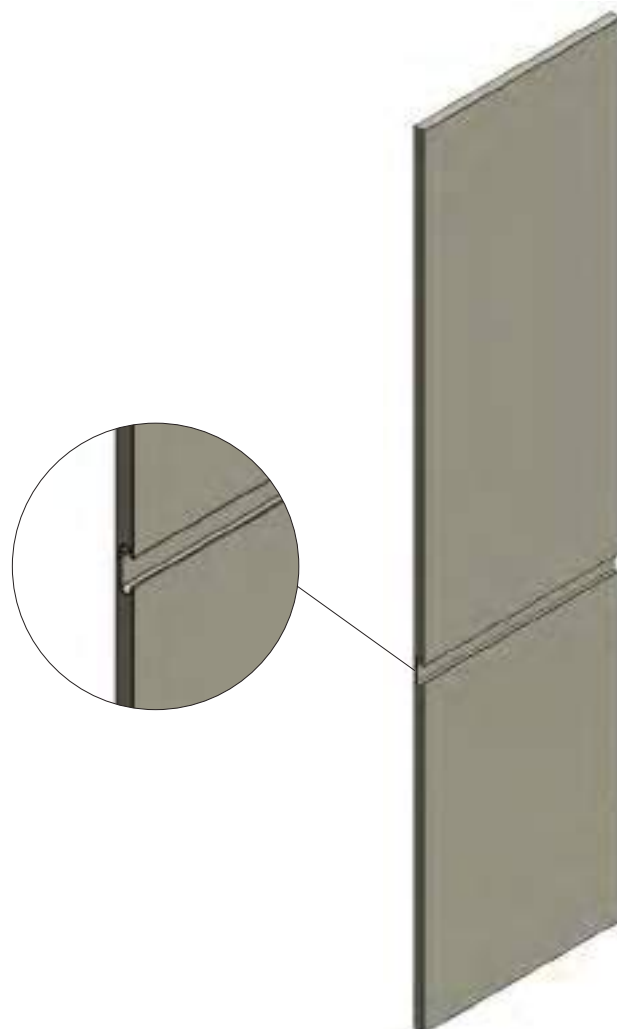

TIPO E+D ANTA PRESA VERTICALE DX
ANTA PRESA VERTICALE RIDOTTA SX
per colonne "NOOK" ante rientranti

TYPE E+D DOOR WITH RH VERTICAL GRIP
DOOR WITH LH REDUCED VERTICAL GRIP
for "NOOK" columns inward doors

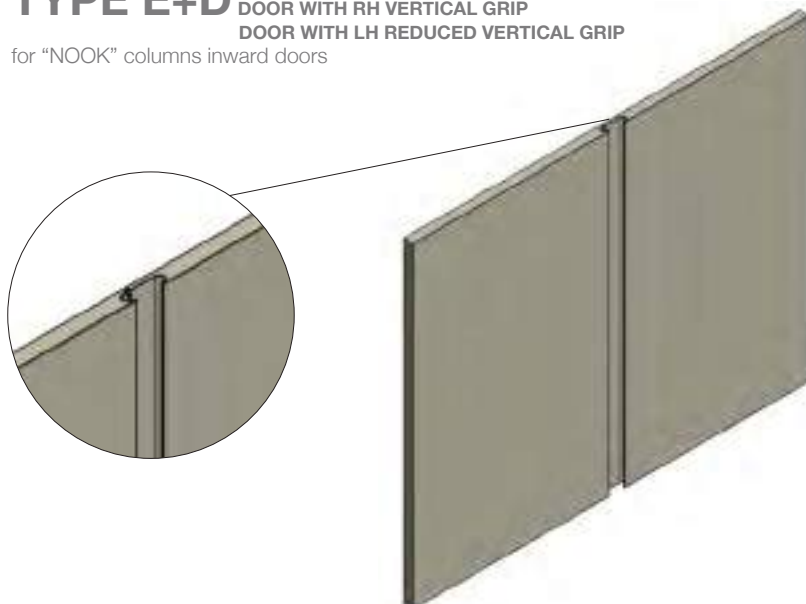

ESEMPI DI ABBINAMENTO PROFILI MANIGLIA

EXAMPLES OF COMBINATIONS FOR HANDLE PROFILES

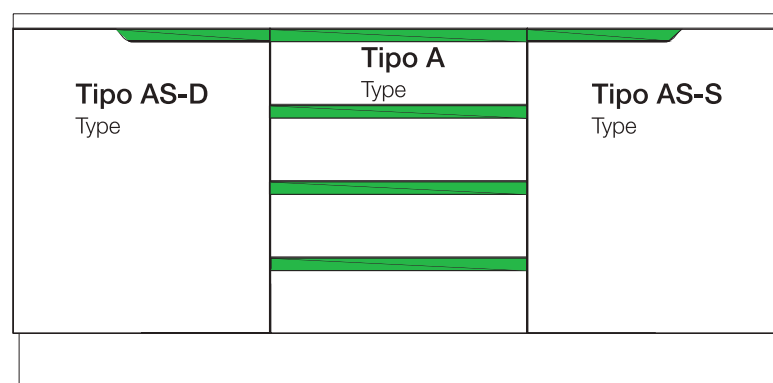
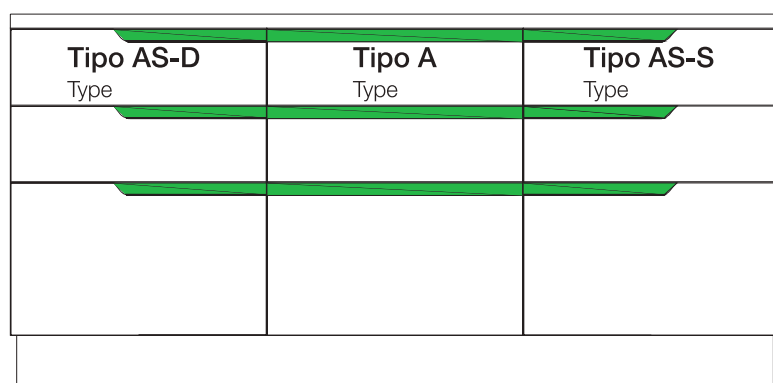
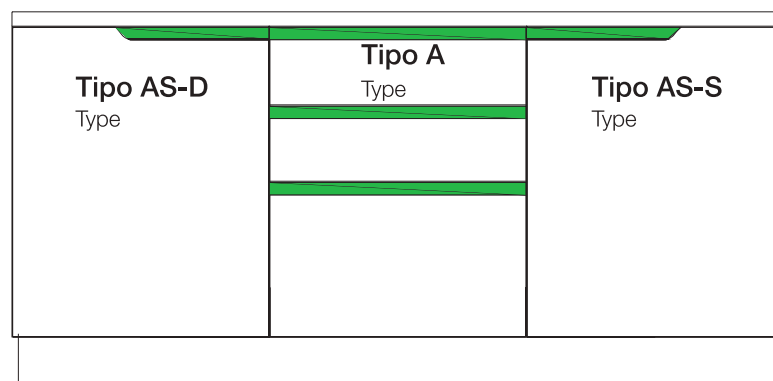
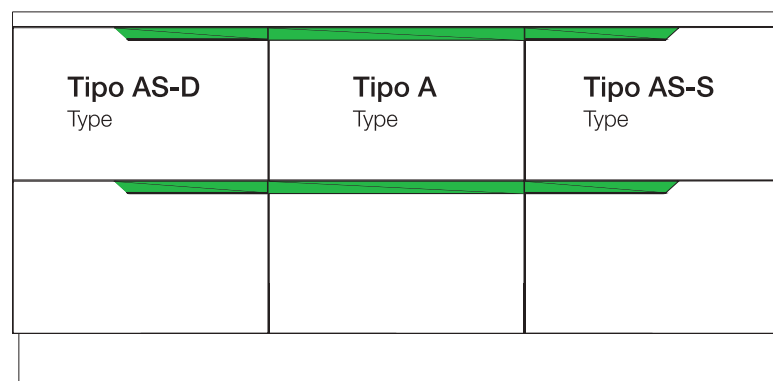
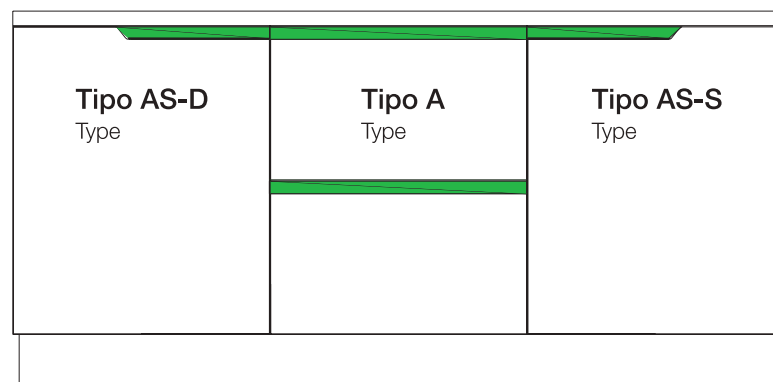
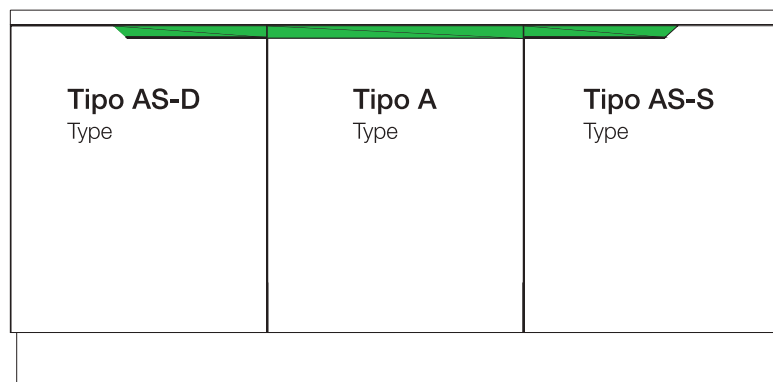

ESEMPI DI ABBINAMENTO PROFILI MANIGLIA

EXAMPLES OF COMBINATIONS FOR HANDLE PROFILES

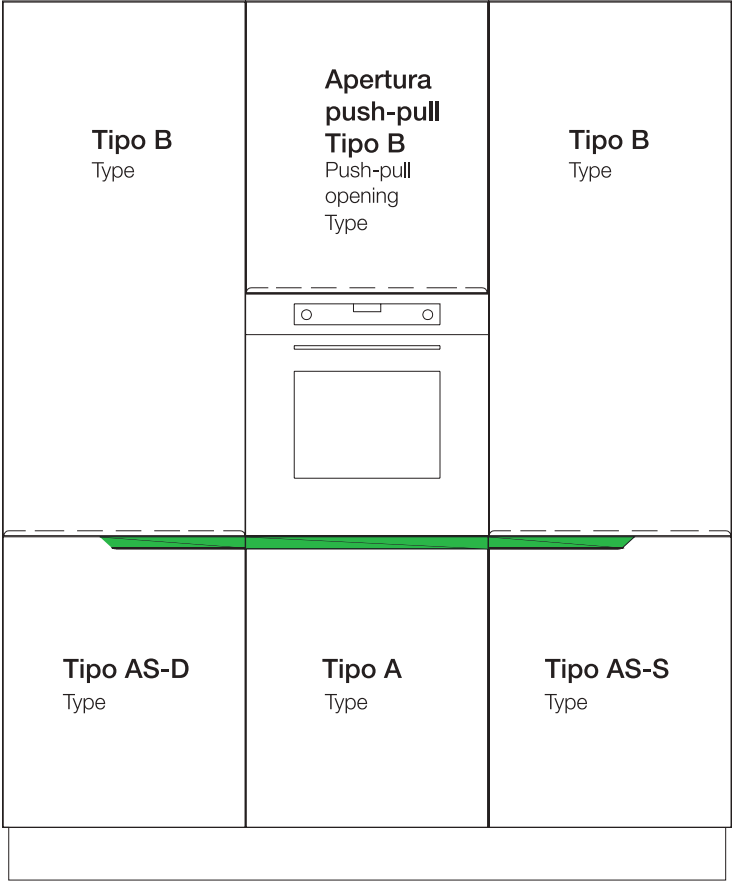
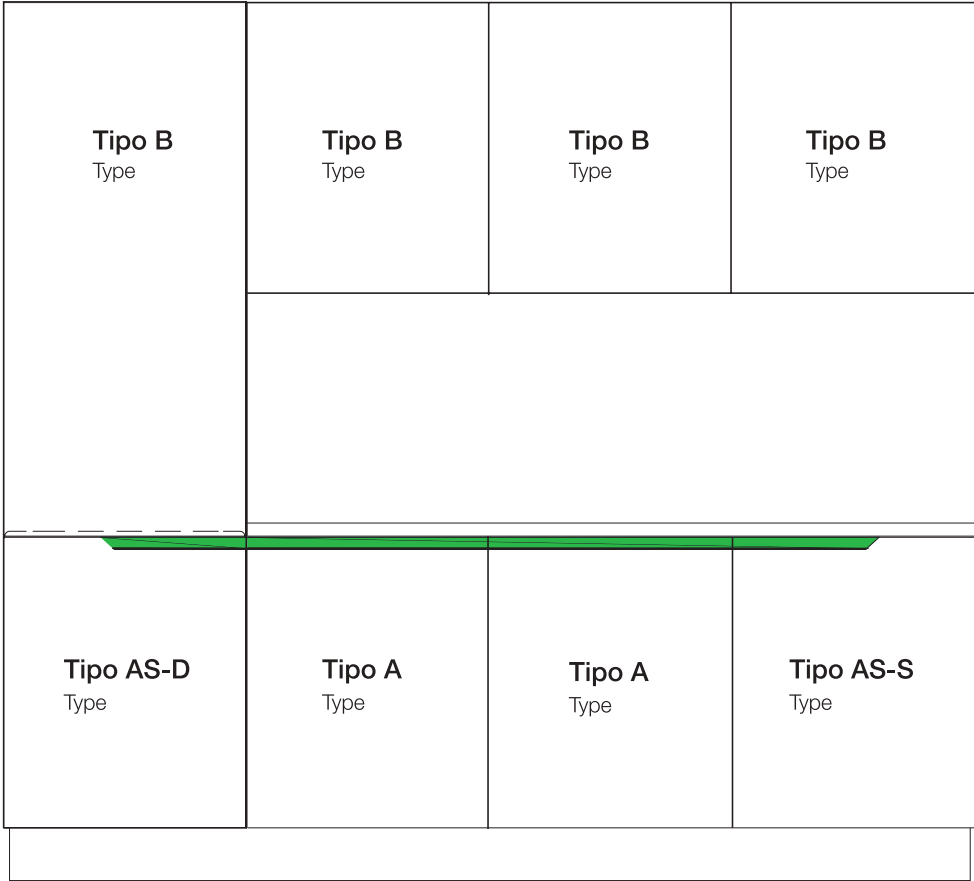

ESEMPI DI ABBINAMENTO PROFILI MANIGLIA

EXAMPLES OF COMBINATIONS FOR HANDLE PROFILES

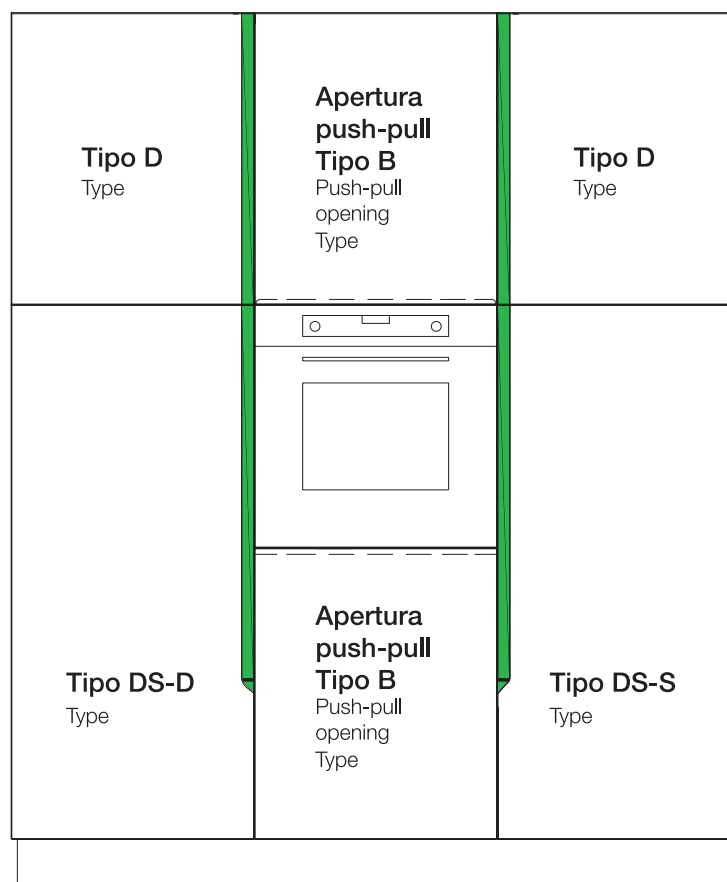
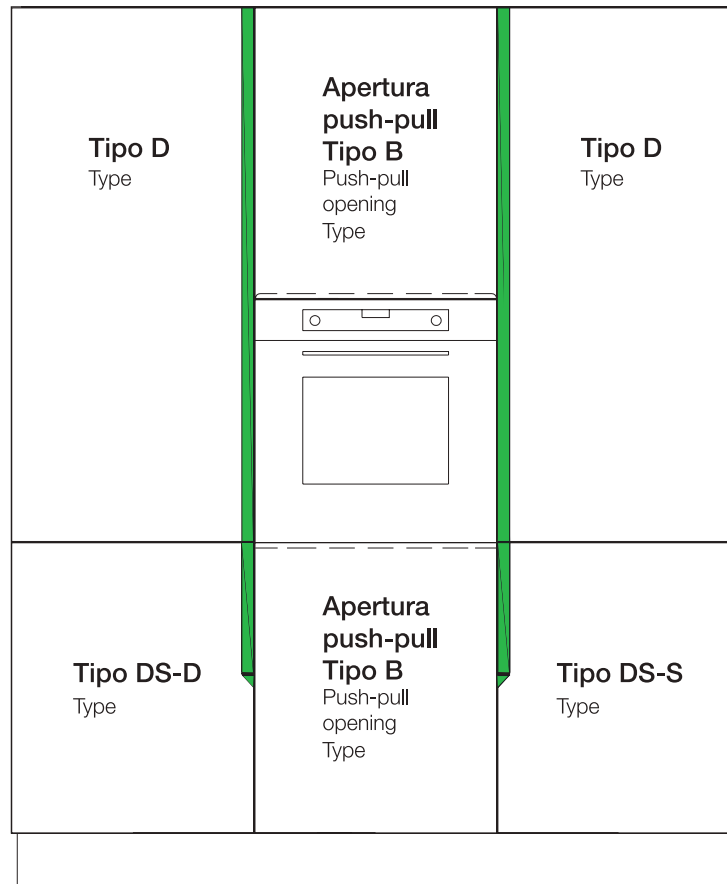

ESEMPI DI ABBINAMENTO PROFILI MANIGLIA

EXAMPLES OF COMBINATIONS FOR HANDLE PROFILES

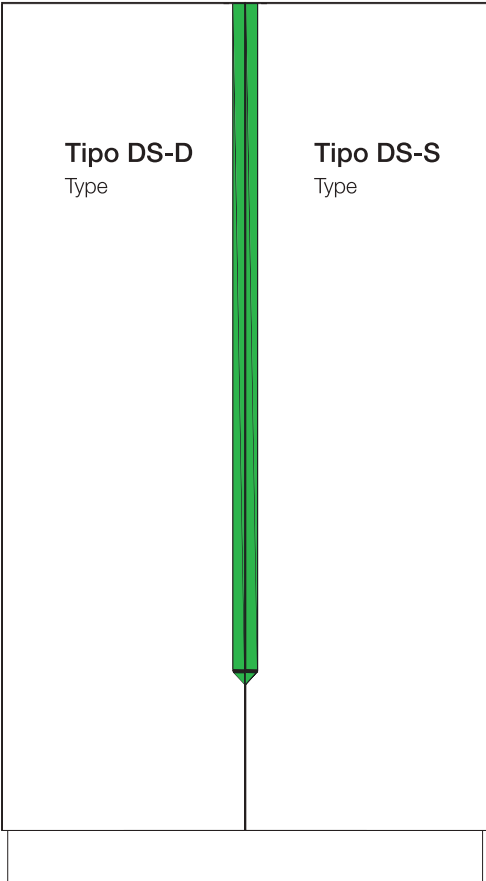
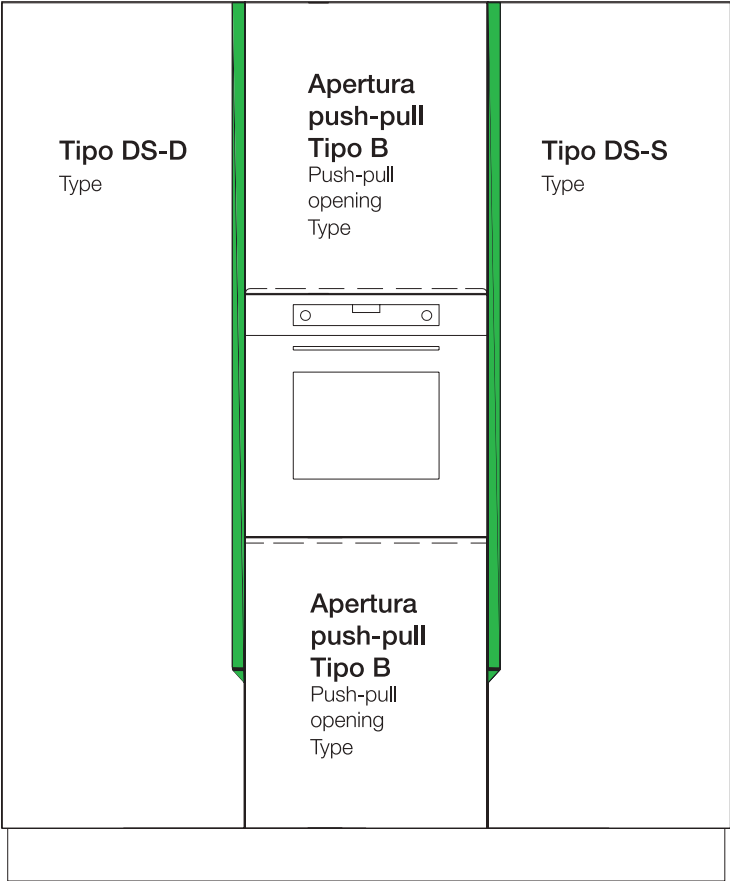

strutture carcasses



bianco (opz.001)
schiena e ripiano bianco
(opz.001)
white (opt.001)
white back panel and shelf
(opt.001)



visone (opz.948M)
schiena e ripiano visone
(opz.948M)
mink (opt.948M)
mink back panel and shelf
(opt.948M)



lavagna (opz.9620)
schiena e ripiano lavagna
(opz.9620)
slate grey (opt.9620)
slate grey back panel
and shelf (opt.9620)



fango (opz.8860)
schiena e ripiano fango
(opz.8860)
mud (opt.8860)
mud back panel and shelf
(opt.8860)



perla d'oriente (opz.940)
schiena e ripiano bianco
(opz.001)
oriental pearl (opt.940)
white back panel and shelf
(opt.001)



devalè finitura grafis
(opz.796) schiena e ripiano
bianco (opz.001)
devalè with grafis finish
(opt.796)
white back panel and shelf
(opt.001)



LUBE ECOLOGIC

IL GRUPPO LUBE HA SCELTO DI UTILIZZARE PER I COMPONENTI COSTITUENTI LE STRUTTURE DELLE CUCINE SOLO MATERIALE A BASSISSIMA EMISSIONE DI FORMALDEIDE: CONFORMI ALLO STANDARD F**** SECONDO LA NORMA JIS, CERTIFICATO DAL MINISTERO GIAPPONESE, IL PIÙ SEVERO IN MERITO ALLE NORMATIVE DI SALVAGUARDIA AMBIENTALE.

LUBE GROUP HAS CHOSEN TO EXCLUSIVELY USE MATERIALS WITH VERY LOW FORMALDEHYDE EMISSIONS FOR THE COMPONENTS MAKING UP THE KITCHEN CARCASSES: THESE ELEMENTS COMPLY WITH THE F4 STAR STANDARD ACCORDING TO JIS, CERTIFIED BY THE JAPANESE GOVERNMENT - THE MOST STRINGENT WHEN IT COMES TO ENVIRONMENTAL PROTECTION.

mensole in nobilitato P 31-61 come strutture same colours as carcasses melamine-coated shelves D 31-61



bianco (opz.001)
white (opt.001)



visone (opz.948M)
mink (opt.948M)



lavagna (opz.9620)
slate grey (opt.9620)



fango (opz.8860)
mud (opt.8860)



perla d'oriente (opz.940)
oriental pearl (opt.940)



devalè finitura grafis (opz.796)
devalè with grafis finish (opt.796)

mensole malta laccata malta lacquered shelves



N.B.: per le finiture vedi pagina 11
Note: for the finishes see page 11

mensole laccate lacquered shelves



laccate opache e lucide
N.B.: per le finiture vedi pagine 14-15
matt and glossy lacquered
Note: for the finishes see pages 14-15

mensole impialacciate veneered shelves



N.B.: per le finiture vedi pagine 8-9
Note: for the finishes see pages 8-9

zoccoli in pvc H 13 pvc plinth H 13

di serie
standard



acciaio (opz.407)
steel (opt.407)



alluminio satinato
(opz.405)
satin aluminium
(opt.405)



bianco (opz.001)
white (opt.001)

zoccoli in alluminio H 13 aluminium plinth H 13



alluminio
finitura brill (opz.412)
aluminium
brill finish (opt.412)

al ml
per lm

cod.092125
code

angolare
angular

cod.0923933
code

zoccoli in alluminio H 13 verniciati a polvere finitura opaca aluminium plinth height H 13 powder coated matt finish



alluminio finitura bianco
assoluto (opz.740S)
aluminium absolute
white finish (opt.740S)



alluminio finitura
argilla (opz.9503)
aluminium clay
finish (opt.9503)



alluminio finitura
grigio bromo (opz.9533)
aluminium bromine grey
finish (opt.9533)

al ml
per lm

cod.092125
code

angolare
angular

cod.0923933
code



alluminio finitura
bianco caldo (opz.7401)
aluminium warm white
finish (opt.7401)



alluminio finitura grigio
kenia (opz.9501)
aluminium kenya grey
finish (opt.9501)



alluminio finitura
castoro (opz.8907)
aluminium beaver
finish (opt.8907)



alluminio finitura fumo
(opz.9531)
aluminium
smoke finish (opt.9531)



alluminio bistro
(opz.9535)
aluminium bistro
finish (opt.9535)

top H 4 consigliati in laminato bordo ABS 1 recommended laminate worktops H 4 with ABS 1 edge



top H 4 consigliati in laminato Fenix recommended laminate worktops H 4 with Fenix



top H 4 consigliati in laminato Unicolor recommended laminate worktops H 4 with Unicolor



top H 1,2 consigliati in stratificato Hpl recommended layered worktops H 1,2 with Hpl

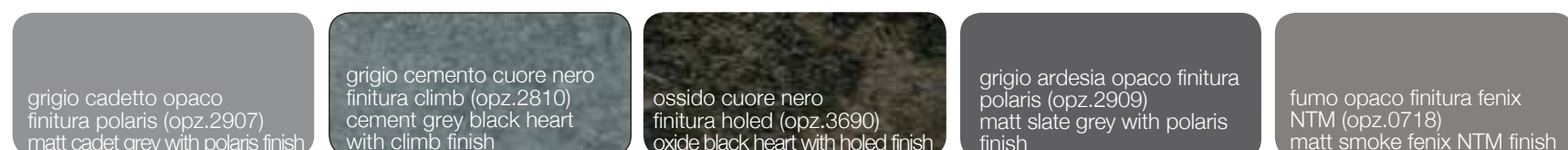

consigli per abbinamento dei colori
recommended colour combinations

**anta
impiallacciata**
veneered door

anta laccata
lacquered door

anta malta
mortar door

elementi a giorno
open units

top
worktops



rovere natur (opz.5440)
fiamma orizzontale
natur oak (opt.5440),
horizontal grain



bianco caldo (opz.7401)
warm white (opt.7401)



calce (opz.LM23)
lime (opt.LM23)



castoro (opz.8907)
beaver (opt.8907)



top laminato ABS1
malta visone vintage
finitura plamky (opz.5568)
laminato ABS1 worktop
vintage mink mortar with
plamky finish (opt.5568)



rovere moresco (opz.5433)
fiamma orizzontale
moorish oak (opt.5433),
horizontal grain



fumo (opz.9531)
smoke (opt.9531)

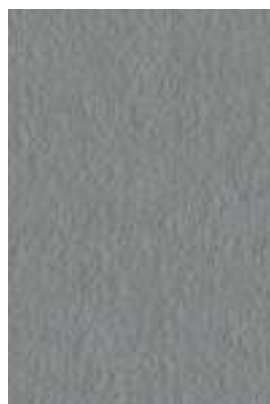

grigio Londra (opz.LM24)
london grey (opt.LM24)



bistro (opz.9535)
bistro (opt.9535)



top UNICOLOR
bianco statuario opaco
finitura schiky (opz.5547)
UNICOLOR worktop
statuary white with schiky
finish (opt.5547)



rovere bianco (opz.5429)
fiamma orizzontale
white oak (opt.5429),
horizontal grain

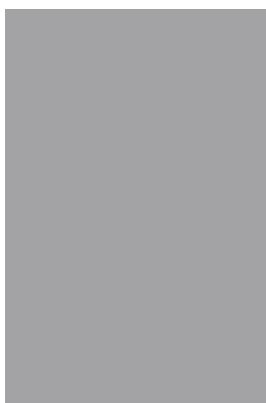

grigio traffico (opz.9511)
traffic grey (opt.9511)



piombo (opz.LM25)
lead (opt.LM25)



cenere (opz.9547)
ash (opt.9547)



top HPL grigio cadetto
opaco finitura polaris
(opz.2907)
HPL worktop matt cadet
grey with polaris finish
(opt.2907)

ABBINAMENTI
E MODULARITÀ
COMBINATIONS
AND MODULARITY

consigli per abbinamento dei colori
recommended colour combinations

**anta
impiallacciata**
veneered door

anta laccata
lacquered door

anta malta
mortar door

elementi a giorno
open units

top
worktops

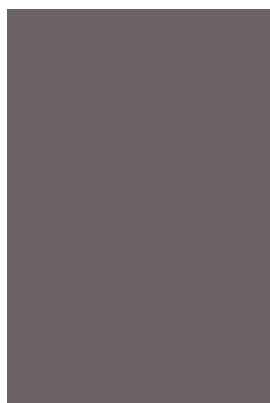

rovere lino (opz.5430)
fiamma orizzontale
linen oak (opt.5430),
horizontal grain

grigio piombo (opz.9537)
lead grey (opt.9537)

grigio Londra (opz.LM24)
london grey (opt.LM24)

lino (opz.9513)
linen (opt.9513)

top HPL grigio cemento
cuore nero finitura climb
(opz.2810)
HPL worktop cement
grey black heart with
climb finish (opt.2810)

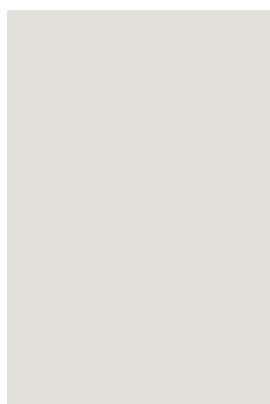

noce canaletto (opz.1331)
fiamma orizzontale
canaletto walnut (opt.1331),
horizontal grain

lino (opz.9513)
linen (opt.9513)

sabbia (opz.LM22)
sand (opt.LM22)

grigio kenya (opz.9501)
kenya grey (opt.9501)

top laminato FENIX
cacao orinoco (opz.0749)
lamine FENIX worktop
orinoco cocoa (opt.0749)

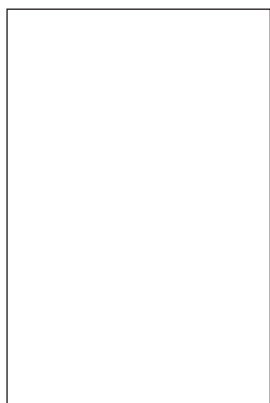

rovere carbon (opz.5434)
fiamma orizzontale
carbon oak (opt.5434),
horizontal grain

bianco assoluto (opz.740S)
absolute white (opt.740S)

bianco (opz.LM21)
white (opt.LM21)

bistro (opz.9535)
bistro (opt.9535)

top laminato ABS1
bardiglio grigio finitura
plamky (opz.6075)
lamine ABS1 worktop
grey bardiglio with
plamky finish (opt.6075)

consigli per abbinamento dei colori

recommended colour combinations

anta impiallacciata

veneered door

anta laccata

lacquered door

anta malta

mortar door

elementi a giorno

open units

top

worktops



rovere grigio traffico
(opt.5431) fiamma
orizzontale
traffic grey oak (opt.5431),
horizontal grain

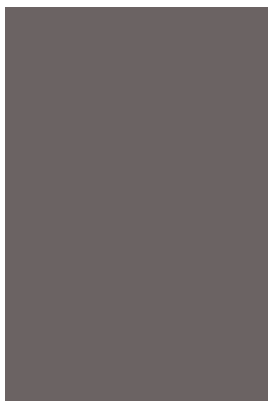

grigio piombo (opt.9537)
lead grey (opt.9537)



piombo (opt.LM25)
lead (opt.LM25)



rosso toscano (opt.8157)
tuscan red (opt.8157)



top HPL ossido cuore
nero finitura holed
(opt.3690)
HPL worktop oxide black
heart with holed finish
(opt.3690)



rovere grigio reale
(opt.5432) fiamma
orizzontale
royal grey oak (opt.5432),
horizontal grain

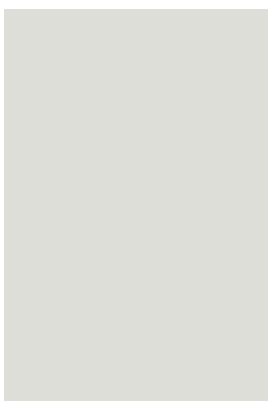

cenere (opt.9547)
ash (opt.9547)



piombo (opt.LM25)
lead (opt.LM25)



verde positano (opt.8471)
positano green (opt.8471)



top laminato ABS1
old grey finitura urban
(opt.LM12)
laminato ABS1 worktop
old grey with urban finish
(opt.LM12)

MODULARITÀ E COMPONIBILITÀ MODULARITY AND FITTING SOLUTIONS

COLONNE FRIGO

FRIDGE COLUMNS

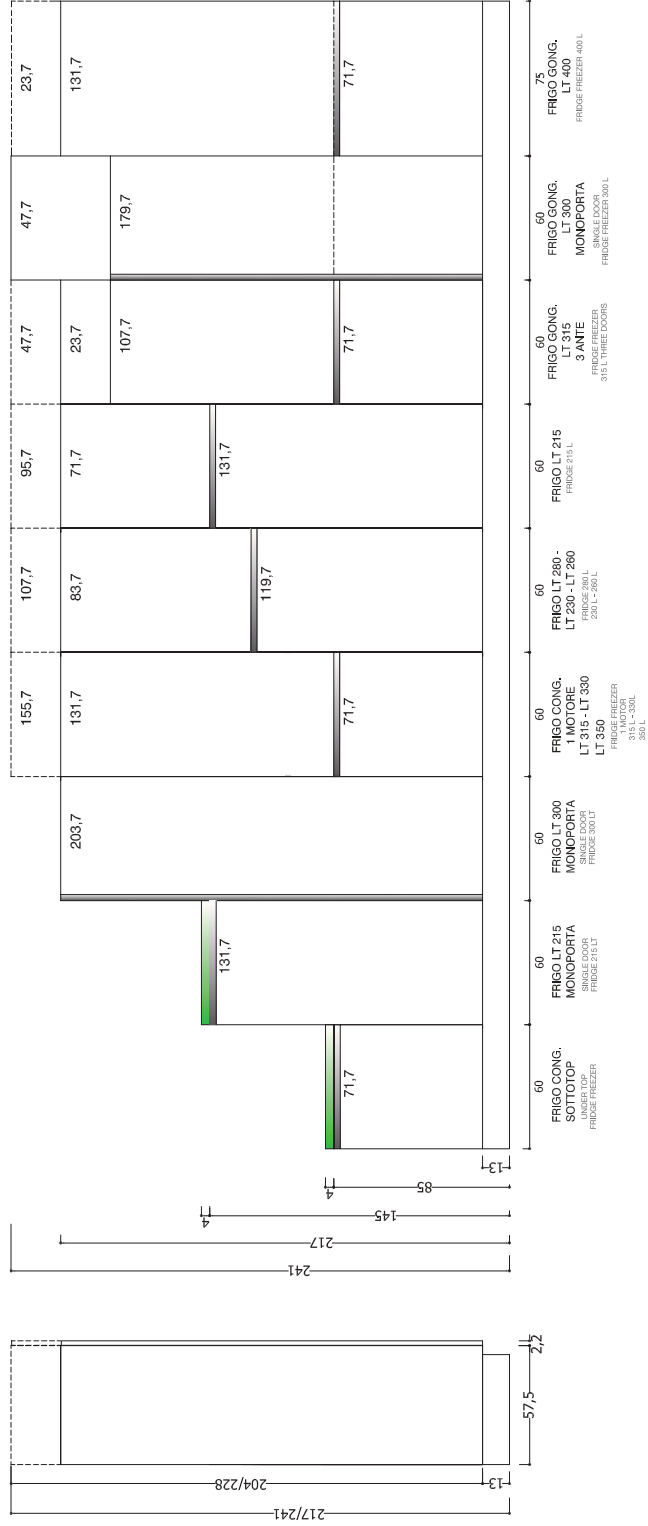

COLONNE FORNO

OVEN COLUMNS

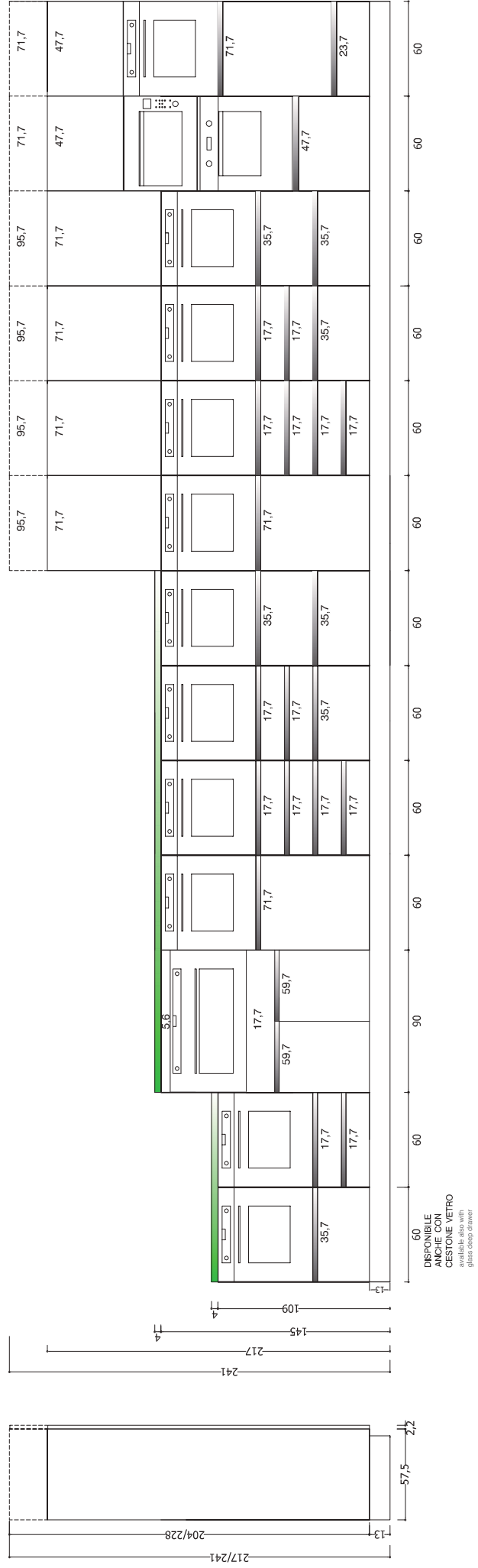

60 DISPONIBILE ANCHE CON GESTIONE VETRO available also with glass damp drawer



APERTURA A RIBALTA

Le ante aprendosi verso l'alto consentono di avere un' ampia visione d'insieme all'interno del mobile.

La regolazione della forza di apertura può essere impostata in modo esatto in base al peso del frontale. Grazie all'arresto progressivo le ante si fermano in qualsiasi posizione; in questo modo la maniglia è sempre facilmente raggiungibile. La chiusura è ammortizzata e un'unica manovra è sufficiente per regolare il frontale tridimensionalmente grazie all'assenza di cerniere e al sistema di aggancio clip.

WALL UNIT WITH FLAP DOOR

The doors that open upwards guarantee ample overall visibility inside the cabinet.

The opening force can be adjusted precisely according to the weight of the front. The doors stop in any position thanks to the gradual stopping movement; in this way, the handle is always easily accessible. The closing movement is cushioned and a single manoeuvre is required to three-dimensionally adjust the front, thanks to the clip-on system and the absence of hinges.



DI SERIE
STANDARD



MOTORIZZATO
SERVO-DRIVE
SERVO-DRIVE
MOTORISED
(Opz.007)



	A	B	C
H 36	11,5	3,5	37
H 48	15	3,5	49
H 60	18,5	3,5	61

Per evitare l'interferenza dell'anta in fase di apertura con cornici o mensole, si può richiedere il limitatore dell'angolo di apertura cod. 5620010

In order to avoid that the door interferes with cornices or shelves during the opening movement, it is possible to request an opening angle limiter: code 5620010

SCHEMA MONTAGGIO LIMITATORE PER RIBALTA H 36
FLAP DOOR LIMITER INSTALLATION DIAGRAM H 36

SCHEMA MONTAGGIO LIMITATORE PER RIBALTA H 48
FLAP DOOR LIMITER INSTALLATION DIAGRAM H 48

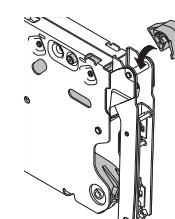
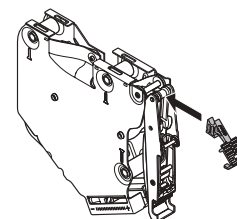

APERTURA VERTICALE OBLIQUA

I pensili con questo tipo di meccanismo necessitano per l'apertura di poco spazio libero sopra il mobile grazie al movimento basculante dell'anta che si apre senza difficoltà applicando poca forza anche in presenza di frontali pesanti. Con l'arresto progressivo le ante si fermano in qualsiasi posizione; in questo modo la maniglia è sempre facilmente raggiungibile. La chiusura è ammortizzata ed è possibile regolare la forza di tenuta in base al peso del frontale.

VERTICAL OPENING OBLIQUE

Wall units that mount this type of mechanism require little clearance above the cabinet thanks to the swivelling movement of the door that can be easily opened by applying slight pressure, even with heavy fronts. The doors stop in any position thanks to the gradual stopping movement; in this way, the handle is always easily accessible. The closing movement is cushioned and the closing force can be adjusted according to the weight of the front door.



DI SERIE
STANDARD



MOTORIZZATO
SERVO-DRIVE
SERVO-DRIVE
MOTORISED
(Opz.007)

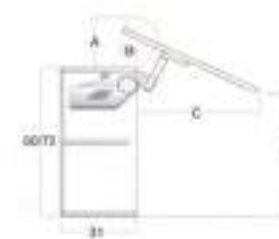

	A	B	C	D
H 60	18	9,6	46,5	53,5
H 72	18	9,6	57	61



Grazie al meccanismo TIP-ON, le ante a ribalta senza maniglia possono essere aperte semplicemente con un leggero tocco. Per chiudere l'anta a ribalta, è sufficiente esercitare una leggera pressione, che grazie ad una piastrina di bloccaggio, applicata sul lato interno del frontale, ne assicura la perfetta chiusura.

Thanks to TIP-ON mechanism, the flap doors without handles can be opened with a simple touch. To close the flap door, just exercise light pressure, thanks to the locking plate, applied on the inner side of the front panel ensures a perfect closure.

APERTURA VERTICALE

L'anta ad apertura verticale, potendo essere sollevata completamente verso l'alto, consente un accesso totale all'interno del pensile. Ideale per l'impiego in mobili a colonna per nascondere ad esempio apparecchi elettrici, o pensili con corpi mobili sovrastanti, ha la chiusura ammortizzata e la possibilità di regolare la forza di tenuta in base al peso del frontale.

VERTICAL OPENING

Doors with vertical opening movement can be fully raised to fully access the inside of the wall unit.

Ideal for use on column units to conceal electrical appliances for examples, or on wall units surmounted by mobile units.

The closing movement is cushioned and the closing force can be adjusted according to the weight of the front door.



**DI SERIE
STANDARD**



**MOTORIZZATO
SERVO-DRIVE
SERVO-DRIVE
MOTORISED
(Opz.007)**

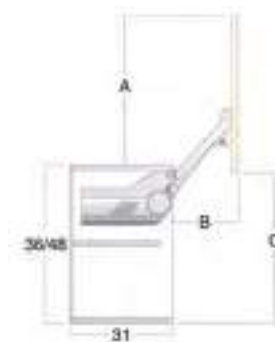

	A	B	C
H 36	34	23,5	34,5
H 48	43	28,5	43,5

APERTURA ANTE A PACCHETTO

Il meccanismo d'apertura ante a pacchetto è idoneo sul pensile H 72; la regolazione della forza di apertura può essere impostata in modo esatto in base ai pesi dei frontali, la chiusura è ammortizzata e la cerniera centrale clip si contraddistingue per l'innovativa tecnologia che garantisce la sicurezza per le dita.

LIFT-UP FOLDING DOORS

The lift-up folding door opening mechanism is suitable for wall units with H 72; the opening force can be adjusted precisely according to the weight of the fronts, while the closing movement is cushioned and the central clip-on hinge features innovative technology for safeguarding the fingers.



**DI SERIE
STANDARD**



**MOTORIZZATO
SERVO-DRIVE
SERVO-DRIVE
MOTORISED
(Opz.007)**

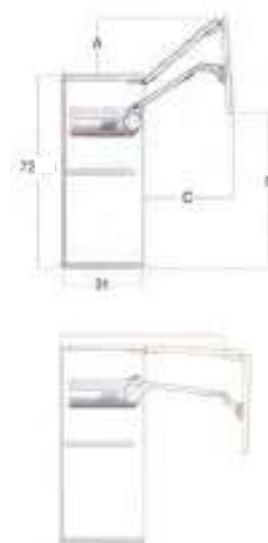

	A	B	C
H 72	16,5	54	41

**SCHEMA MONTAGGIO
LIMITATORE
LIMITER INSTALLATION
DIAGRAM**

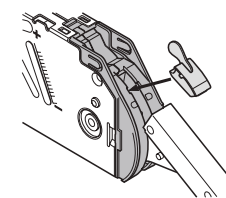

Per evitare l'interferenza dell'anta in fase di apertura con cornici o mensole, si può richiedere il limitatore dell'angolo di apertura cod. 5620005

In order to avoid that the door interferes with cornices or shelves during the opening movement, it is possible to request an opening angle limiter: code 5620005





COLONNE ARMADIO “NOOK” H 217 P 70,4 CON ANTE A SCOMPARSA

“NOOK” CLOSET COLUMNS H 217 D 70,4 WITH DOORS INWARDS

Le colonne armadio “Nook” con ante a scomparsa, consentono di inserire all’interno forno, frigo, tavolo e cassetti

“Nook” closet columns with pull-out doors allow to insert oven, fridge, table and drawer on the inside



COLONNE ARMADIO “NOOK” H 217 P 70,4 CON ANTE A SCOMPARSA

“NOOK” CLOSET COLUMNS H 217 D 70,4 WITH DOORS INWARDS

Il tavolo estraibile è disponibile nella versione inox o in laminato, nella finitura oak cognac

The pull-out table it's available in stainless steel version or laminate oak cognac finish



CABINA RIPOSTIGLIO

CLOSET COLUMN



ANTE VETRO GLASS DOORS



telaio impiallacciato con
vetro satinato
veneered frame with
satin glass



telaio impiallacciato con
vetro bronzo
veneered frame with
bronze glass



telaio laccato con vetro
satinato
lacquered frame with
satin glass



telaio laccato con vetro
bronzo
lacquered frame with
bronze glass

N.B.: per colori vedi pag. 8-15
NOTE: for colours see pages 8-15

COLORI STRUTTURA INTERNA IN NOBILITATO COLOURS FOR INTERNAL MELAMINE-COATED STRUCTURE

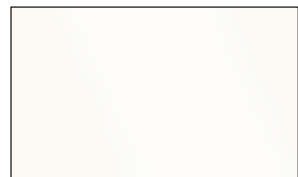

bianco (opz.001)
white (opt.001)



visone (opz.948M)
mink (opt.948M)



lavagna (opz.9620)
slate grey (opt.9620)



fango (opz.8860)
mud (opt.8860)

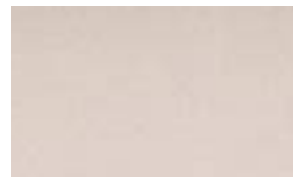

perla d'oriente (opz.940)
oriental pearl (opt.940)



devalè finitura grafis
(opz.796)
devalè with grafis finish
(opt.796)

COLORI ANTE CHIUSE E PANNELLI FISSI FRONTALE E LATERALE COLOURS FOR DOORS AND FIXED FRONT LATERAL PANELS



IMPIALLACCIATI **per colori vedi pag.8-9**
VENEERED **for colours see page 8-9**



MALTA LACCATA OPACA **per colori vedi pag.11**
MATT LACQUERED MORTAR FINISH **for colours see page 11**

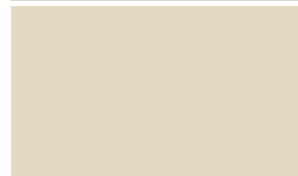

LACCATI OPACHI E LUCIDI **per colori vedi pag.14-15**
MATT AND GLOSSY LACQUERED **for colours see page 14-15**



COLORI STRUTTURA INTERNA
INTERNAL CARCASS COLOURS

MELAMINICI
MELAMINE

bianco (opz.001) white (opt.001)	visone (opz.948M) mink (opt.948M)	lavagna (opz.9620) slate grey (opt.9620)	fango (opz.8860) mud (opt.8860)
-------------------------------------	--------------------------------------	---	------------------------------------



IMPIALLACCIATI per colori vedi pag.8-9
VENEERED for colours see page 8-9



MALTA LACCATA OPACA per colori vedi pag.11
MATT LACQUERED MORTAR FINISH for colours see page 11



LACCATI OPACHI per colori vedi pag.14
MATT LACQUERED for colours see page 14

ELEMENTI A GIORNO IN LAMIERA VERNICIATI A POLVERE SP.2 MM

POWDER PAINTED METAL SHEET OPEN UNITS TH.2 MM



colori opachi
matt colours

	NEW				
grigio bromo (opz.9533) bromine grey (opt.9533)	grigio traffico (opz.9511) traffic grey (opt.9511)	argilla (opz.9503) clay (opt.9503)	nero (opz.7892) black (opt.7892)	bianco caldo (opz.7401) warm white (opt.7401)	grigio kenya (opz.9501) kenya grey (opt.9501)
castoro (opz.8907) beaver (opt.8907)	fumo (opz.9531) smoke (opt.9531)	verde positano (opz.8471) positano green (opt.8471)	rosso toscano (opz.8157) tuscan red (opt.8157)	NEW lino (opz.9513) linen (opt.9513)	NEW creta (opz.9515) clay (opt.9515)
NEW conchiglia (opz.7403) shell (opt.7403)					

ELEMENTI A GIORNO SP. 14 MM

OPEN ELEMENTS TH.14 MM



COLORI IMPIALLACCIATI VENEERED COLOURS

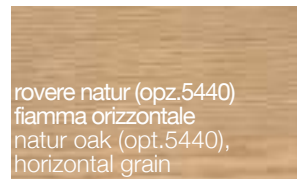
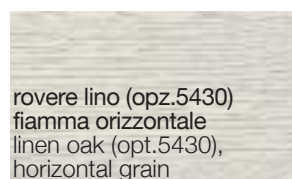
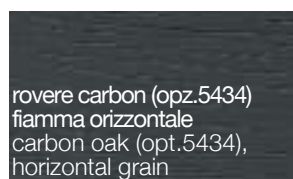
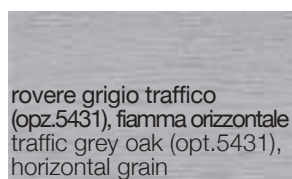
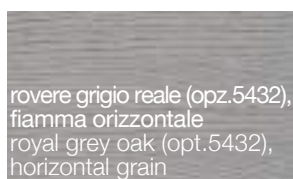

COLORI LACCATI OPACHI MATT LACQUERED COLOURS

COLORI FREDDI OPACHI SOFT SOFT MATT COLD COLOURS

COLORI CALDI OPACHI SOFT SOFT MATT HOT COLOURS

[👉 CLICCA QUI PER LA GAMMA COLORI DISPONIBILI](#)

[👉 CLICK HERE FOR THE RANGE OF AVAILABLE COLORS](#)

SCHIENALI "SHELF" CON MENSOLE IN LAMIERA VERNICIATA

"SHELF" BACK PANELS WITH PAINTED METAL SHEET SHELVES



colori opachi mensole e montanti
matt colours for shelves and stiles

<p>bianco assoluto (opz.740S) absolute white</p>	<p>castoro (opz.8907) beaver</p>	<p>acquamarina (opz.8323) acquamarine</p>	<p>giallo ambra (opz.8225) amber yellow</p>	<p>rosa quarzo (opz.8171) quartz pink</p>	<p>verde acqua (opz.8473) water green</p>
<p>blu fiordaliso (opz.8377) cornflower blue</p>	<p>salvia (opz.8443) sage</p>	<p>grigio bromo (opz.9533) bromine grey</p>	<p>bianco caldo (opz.7401) warm white</p>	<p>fumo (opz.9531) smoke</p>	<p>verde positano (opz.8471) positano green</p>
<p>nero (opz.7892) black</p>	<p>rosso toscano (opz.8157) tuscan red</p>	<p>titanio (opz.414V) titanium</p>		<p>blu cadetto (opz.8373) cadet blue</p>	<p>verde lichene (opz.8463) lichen green</p>
<p>argilla (opz.9503) clay</p>	<p>bistro (opz.9535) bistro</p>	<p>creta (opz.9515) clay</p>	<p>NEW lino (opz.9513) linen</p>	<p>NEW conchiglia (opz.7403) shell</p>	<p>NEW grigio traffico (opz.9511) traffic grey</p>
<p>NEW grigio kenya (opz.9501) kenya grey</p>					

COLORI SCHIENALI

COLOURS FOR BACK PANELS

SCHIENALE IMPIALLACCIATO

VENEERED BACK PANEL



SCHIENALE MALTA LACCATO OPACO

MALTA MATT LACQUERED BACK PANEL

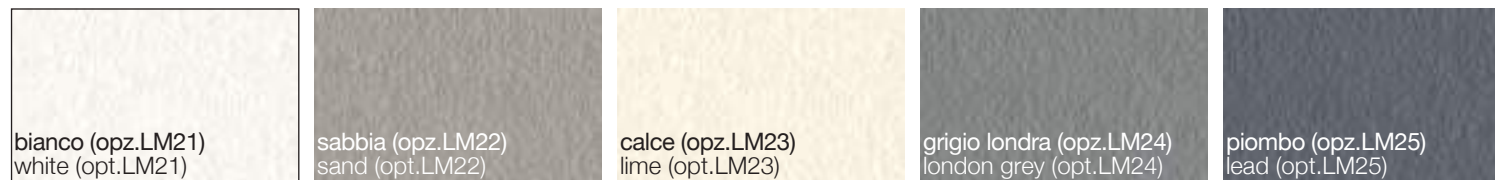

SCHIENALE LACCATO OPACO

MATT LACQUERED BACK PANEL

COLORI FREDDI OPACHI SOFT SOFT MATT COLD COLOURS

COLORI CALDI OPACHI SOFT SOFT MATT HOT COLOURS

[CLICCA QUI PER LA GAMMA COLORI DISPONIBILI](#)

[CLICK HERE FOR THE RANGE OF AVAILABLE COLORS](#)



SCHIENALI "WEAVE" CON MENSOLE LACCATE OPACHE

"WEAVE" BACK PANELS WITH MATT LACQUERED SHELVES



colori opachi per mensole
matt colours for shelves

	NEW				
grigio bromo (opz.9533) bromine grey (opt.9533)	grigio traffico (opz.9511) traffic grey (opt.9511)	argilla (opz.9503) clay (opt.9503)	nero (opz.7892) black (opt.7892)	bianco caldo (opz.7401) warm white (opt.7401)	grigio kenya (opz.9501) kenya grey (opt.9501)
castoro (opz.8907) beaver (opt.8907)	fumo (opz.9531) smoke (opt.9531)	verde positano (opz.8471) positano green (opt.8471)	rosso toscano (opz.8157) tuscan red (opt.8157)	NEW lino (opz.9513) linen (opt.9513)	NEW creta (opz.9515) clay (opt.9515)
NEW conchiglia (opz.7403) shell (opt.7403)					

COLORI SCHIENALI

COLOURS FOR BACK PANELS

SCHIENALE IMPIALLACCIATO

VENEERED BACK PANEL



SCHIENALE LACCATO OPACO

MATT LACQUERED BACK PANEL

COLORI FREDDI OPACHI SOFT SOFT MATT COLD COLOURS

COLORI CALDI OPACHI SOFT SOFT MATT WARM COLOURS

[CLICCA QUI PER LA GAMMA COLORI DISPONIBILI](#)

[CLICK HERE FOR THE RANGE OF AVAILABLE COLORS](#)

SCHIENALI E MENSOLE CON LUCI

BACK PANELS AND SHELVES WITH LIGHTS



SCHIENALE PORTA TV CON LUCE POSTERIORE

TV HOLDER BACK PANEL WITH REAR LIGHT



COLORI SCHIENALI

COLOURS FOR BACK PANELS

SCHIENALE IMPIALLACCIATO

VENEERED BACK PANEL

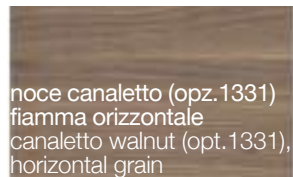
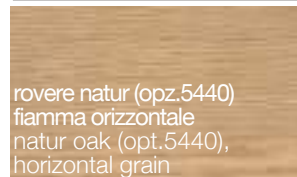
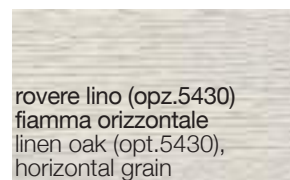
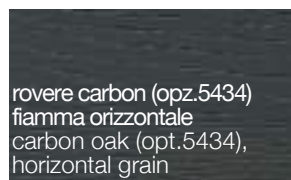
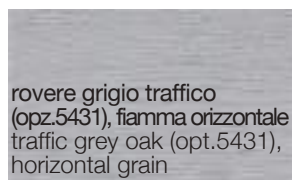
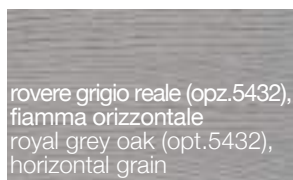

SCHIENALE MALTA LACCATO OPACO

MALTA MATT LACQUERED BACK PANEL

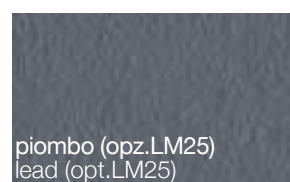
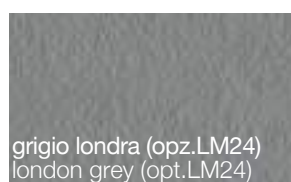
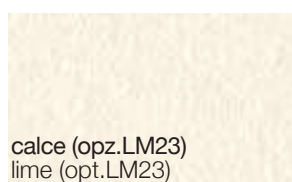
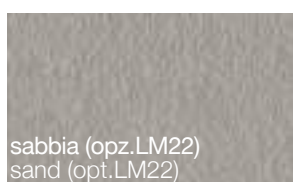
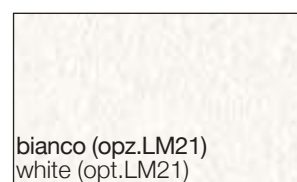

SCHIENALE LACCATO OPACO

MATT LACQUERED BACK PANEL

COLORI FREDDI OPACHI SOFT SOFT MATT COLD COLOURS

COLORI CALDI OPACHI SOFT SOFT MATT WARM COLOURS

[CLICCA QUI PER LA GAMMA COLORI DISPONIBILI](#)

[CLICK HERE FOR THE RANGE OF AVAILABLE COLORS](#)

MOBILE DI FINITURA "SIDE"

"SIDE" FINISHING FURNITURE



COLORI STRUTTURA CARCASS COLOURS



LACCATI OPACHI **per colori vedi pag.14**
MATT LACQUERED **for colours see page 14**

COLORI DIVISORI LACCATI OPACHI MATT LACQUERED DIVIDERS COLOURS



per colori vedi pag.14
for colours see page 14



vetro satinato
satin glass



vetro bronzo
bronze glass

MOBILI PER LIVING "STYLE"

"STYLE" FURNITURE FOR LIVING



ANTE DOORS



IMPIALLACCIATI per colori vedi pag.8-9
VENEERED for colours see page 8-9



LACCATI OPACHI per colori vedi pag.14
MATT LACQUERED for colours see page 14

COLORI SCOCCA ESTERNA E BASAMENTO COLOUR FOR EXTERNAL CARCASS AND BASE



IMPIALLACCIATI per colori vedi pag.8-9
VENEERED for colours see page 8-9



LACCATI OPACHI per colori vedi pag.14
MATT LACQUERED for colours see page 14

COLORI STRUTTURA INTERNA COLOURS FOR INTERNAL CARCASS



LACCATI OPACHI per colori vedi pag.14
MATT LACQUERED for colours see page 14



VIVI IL LIVING

LIVE THE LIVING

Vasta gamma di soluzioni e totale modularità per creare nuove composizioni living adatte ad ogni spazio.

Wide range of solutions and totaly of modules to create new lively furnishing compositions suitable for every kind of space.



LIBRERIA LIVING

LIVING BOOKCASE

La libreria va ad ampliare la gamma living con spessore e carattere. La sua struttura sp.2,5 è perfettamente coordinata alla cucina grazie alla possibilità di integrare le ante del programma Luna.

N.B.: per una corretta preventivazione ed ordine delle librerie, si consiglia l'uso del programma 3cad Evolution

The bookcase expands the living range with substance and character. His th. 2,5 structure is perfectly coordinated with the kitchen, thanks to the possibility to integrate the door finishes of Luna program.

Note: we recommend to use the 3cad Evolution software, for having a correct estimate and order.

FINITURE STRUTTURA SP.2,5 - SCHIENA SP.1

STRUCTURE FINISHES TH.2,5 - BACK PANEL TH.1

MELAMINICO
melamine

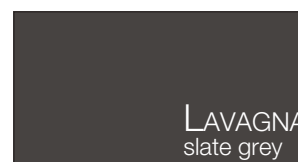
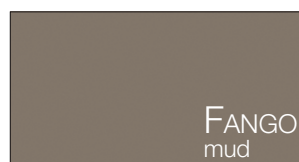

LACCATO OPACO
matt lacquered

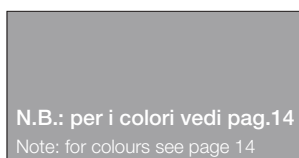

FINITURE ANTE

DOORS FINISHES

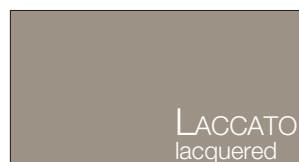
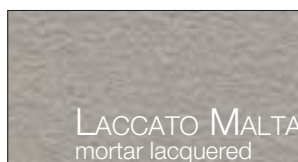
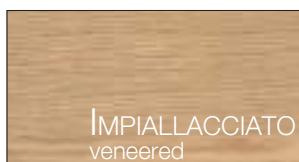

LIVING LL 01



ANTA
door

LACCATO OPACO
matt lacquered



IMPIALLACCIATO
veneered

ELEMENTI A GIORNO
open units

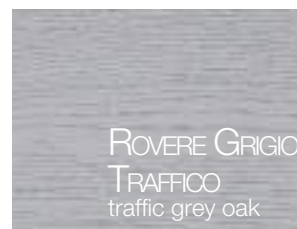

NOBILITATO
melamine-coated

STRUTTURA
carcass



LIVING LL 01

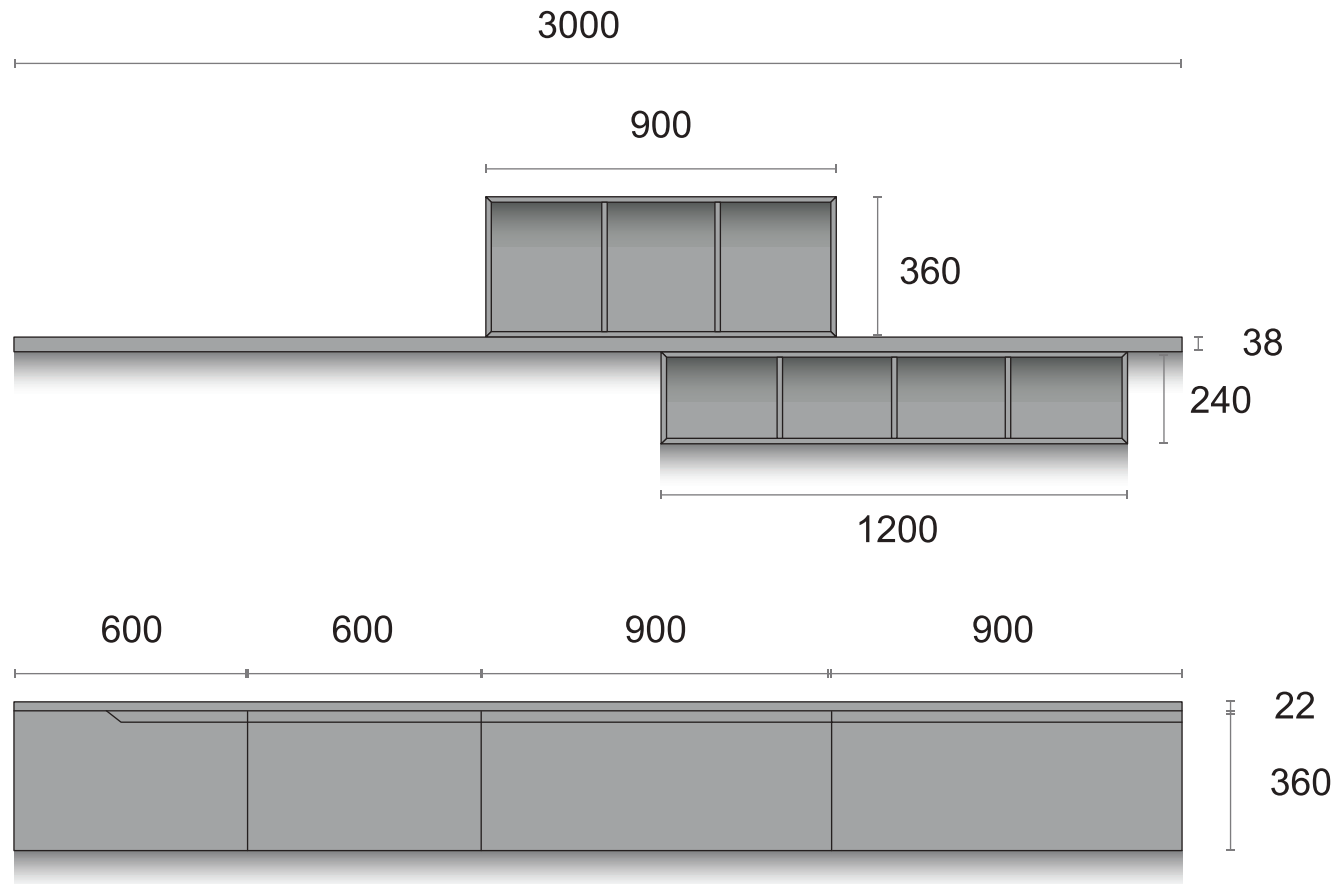

NR. ELEMENTI	DESCRIZIONE	CODICE	
1	Base living sospesa L 60 H 36 P 50,4 1 cestone presa sagomata	EBL75600	
1	Base living sospesa L 60 H 36 P 50,4 1 cestone	EBL75600	
2	Base living sospesa L 90 H 36 P 50,4 1 cestone	EBL75900	
2	Coprifianco H 36 P 48 laccato come anta	T983382	
1	Elemento a giorno L 90 H 36 3 vani, impiallacciato	E7702712	
1	Elemento a giorno L 120 H 24 4 vani, impiallacciato	E7702708	
1	Mensola L 300 P 33,4 SP. 3,8 impiallacciata come anta	al ml	0917237
1	Top living L 300 P 50,4 SP. 2,2 laccata come anta	al ml	TLC225
No. of ELEMENTS	DESCRIPTION	CODE	
1	Hanging living base unit W 60 H 36 D 50,4 1 deep drawer, 1 shaped handle	EBL75600	
1	Hanging living base unit W 60 H 36 D 50,4 1 deep drawer	EBL75600	
2	Hanging living base unit W 90 H 36 D 50,4 1 deep drawer	EBL75900	
2	Lacquered side panel H 36 D 48, same colour as door	T983382	
1	Veneered open unit W 90 H 36 3 compartments	E7702712	
1	Veneered open unit W 120 H 24 4 compartments	E7702708	
1	Veneered shelf W 300 D 33,4 Th.3,8 same colour as door	per lm	0917237
1	Lacquered living worktop W 300 D 50,4 Th.2,2 same colour as door	per lm	TLC225

LIVING LL 02



ANTE
doors

LACCATO MALTA
mortar lacquered

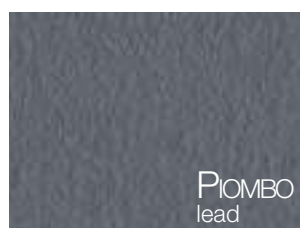

LACCATO OPACO
matt lacquered



STRUTTURA
carcass

NOBILITATO
melamine-coated



LIVING LL 02

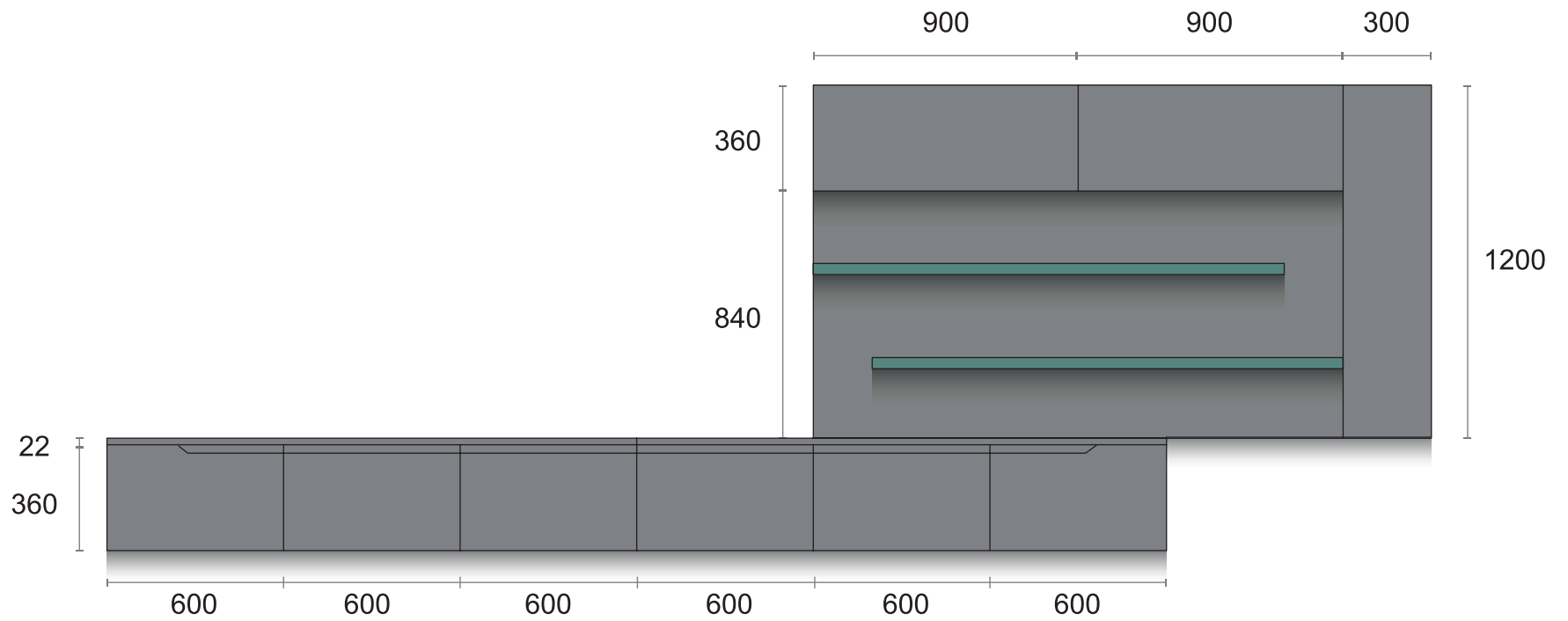

NR. ELEMENTI	DESCRIZIONE	CODICE
2	Pensile L 90 H 36 P 33,4 apertura tip-on	E210090T
1	Pensile L 30 H 120 P 33,4 apertura DX/SX	E2145301/2
2	Base living sospesa L 60 H 36 P 50,4 1 cestone con presa sagomata	EBL75600
4	Base living sospesa L 60 H 36 P 50,4 1 cestone	EBL75600
1	Coprifianco laccato H 36 P 31 colore come anta	T98340
2	Coprifianco laccato H 120 P 31 colore come anta	T98365
2	Coprifianco laccato H 36 P 48 colore come anta	T983382
1	Pannello di finitura L 180 H 84 SP. 2,2 laccato come anta	al mq 094532
2	Mensola L 160 P 31 SP. 3,8 laccata	al ml 091733
2	Top laccato L 180 P 50,4 SP. 2,2	al ml TLC225
2	Asta appendipensili ml 2	08610501

No. of ELEMENTS	DESCRIPTION	CODE
2	Wall unit W 90 H 36 D 33,4 tip-on opening	E210090T
1	Wall unit W 30 H 120 D 33,4 RH/LH opening	E2145301/2
2	Hanging living base unit W 60 H 36 D 50,4 1 deep drawer with shaped handle	EBL75600
4	Hanging living base unit W 60 H 36 D 50,4 1 deep drawer	EBL75600
1	Lacquered side panel H 36 D 31, same colour as door	T98340
2	Lacquered side panel H 120 D 31, same colour as door	T98365
2	Lacquered side panel H 36 D 48, same colour as door	T983382
1	Lacquered finish panel W 180 H 84 Th.2,2 same finish as door	per m ² 094532
2	Lacquered shelf W 160 D 31 Th.3,8	per lm 091733
2	Lacquered worktop W 180 D 50,4 Th.2,2	per lm TLC225
2	Wall unit fixing strip lm 2	08610501

LIVING LL 03



ANTA
door

ELEMENTI A GIORNO
open units

STRUTTURA
carcass

IMPIALLACCIATO
veneered

LACCATO OPACO
matt lacquered

NOBILITATO
melamine-coated

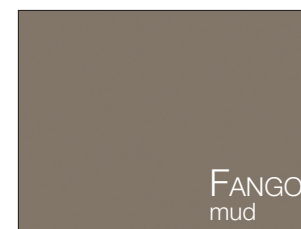
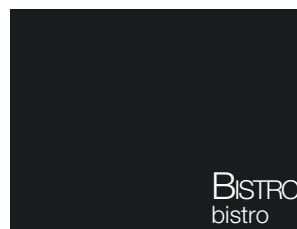
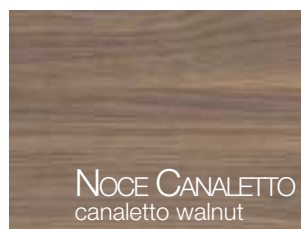

LIVING LL 03

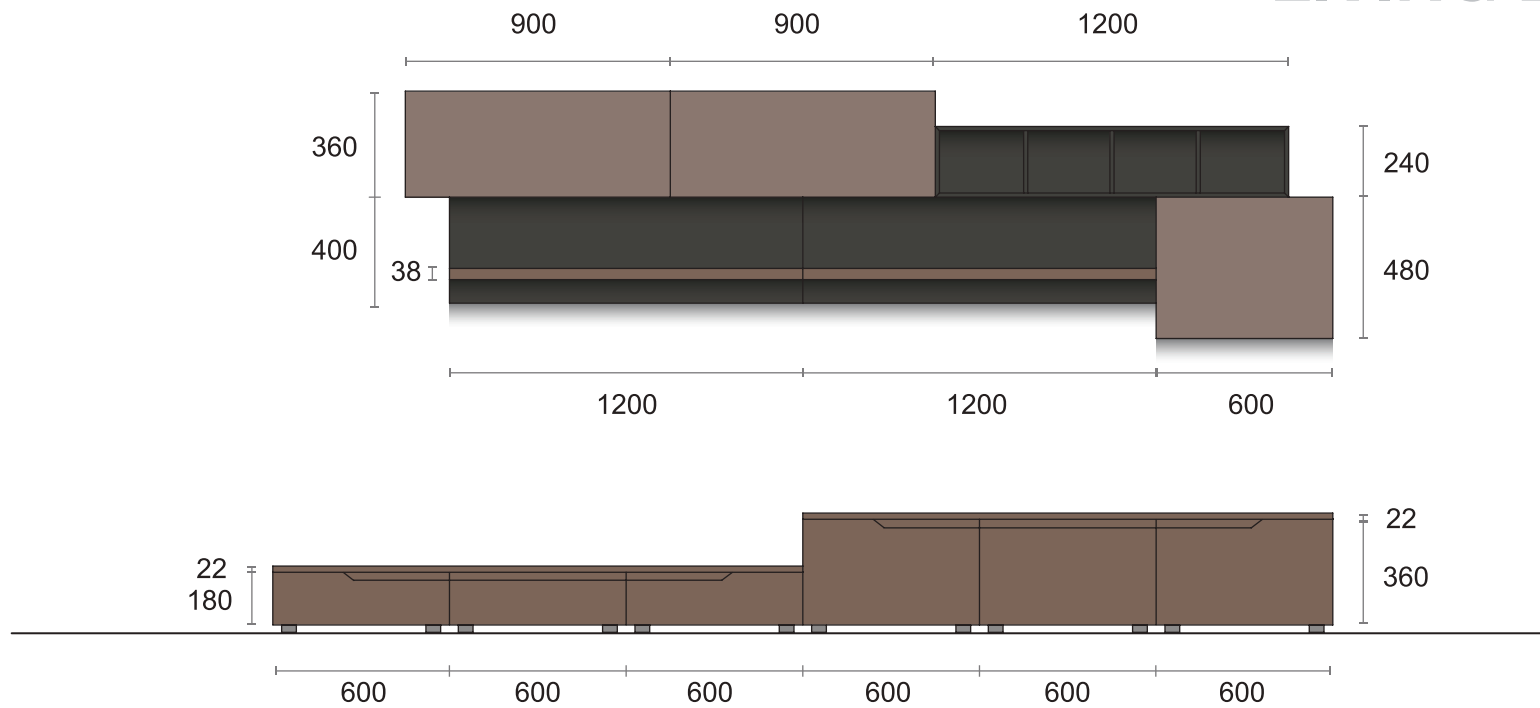

NR. ELEMENTI	DESCRIZIONE	CODICE
2	Pensile L 90 H 36 P 33,4 apertura tip-on, 1 fianco come anta	E210090T
1	Pensile L 60 H 48 P 33,4 fianchi come anta	E2040601/2
1	Base living L 60 H 18 P 50,4 1 cassetto con presa sagomata, 1 fianco come anta	EBL03600
1	Base living L 60 H 18 P 50,4 1 cassetto	EBL03600
1	Base living L 60 H 18 P 50,4 1 cassetto con presa sagomata	EBL03600
2	Base living L 60 H 36 P 50,4 1 cestone con presa sagomata, 1 fianco come anta	EBL25600
1	Base living L 60 H 36 P 50,4 1 cestone	EBL25600
1	Elemento a giorno L 120 H 24 4 vani, laccato opaco	E7701708
2	Pannello di finitura L 120 H 40 SP. 2,2 laccato opaco	al mq 094532
2	Mensola impiallacciata L 120 P 31 SP. 3,8	al ml 091723
2	Top impiallacciato L 180 P 50,4 SP. 2,2	al ml TLH225
2	Asta appendipensili ml 2	08610501
No. of ELEMENTS	DESCRIPTION	CODE
2	Wall unit W 90 H 36 D 33,4 tip-on opening, side same as door	E210090T
1	Wall unit W 60 H 48 D 33,4 sides same as door	E2040601/2
1	Living base unit W 60 H 18 D 50,4 1 drawer with shaped handle, side same as door	EBL03600
1	Living base unit W 60 H 18 D 50,4 1 drawer	EBL03600
1	Living base unit W 60 H 18 D 50,4 1 drawer with shaped handle	EBL03600
2	Living base unit W 60 H 36 D 50,4 1 deep drawer with shaped handle, side same as door	EBL25600
1	Living base unit W 60 H 36 D 50,4 1 deep drawer	EBL25600
1	Matt lacquered open unit W 120 H 24 4 compartments	E7701708
2	Matt lacquered finish panel W 120 H 40 Th.2,2	per m ² 094532
2	Veneered shelf W 120 D 31 Th.3,8	per lm 091723
2	Veneered worktop W 180 D 50,4 Th.2,2	per lm TLH225
2	Wall unit fixing strip lm 2	08610501

LIVING LL 04



ANTA
door

ELEMENTI A GIORNO
open units

STRUTTURA
carcass

IMPIALLACCIATO
veneered

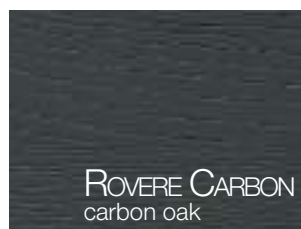

IMPIALLACCIATO
veneered



NOBILITATO
melamine-coated

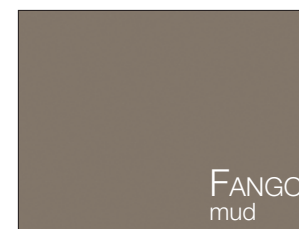

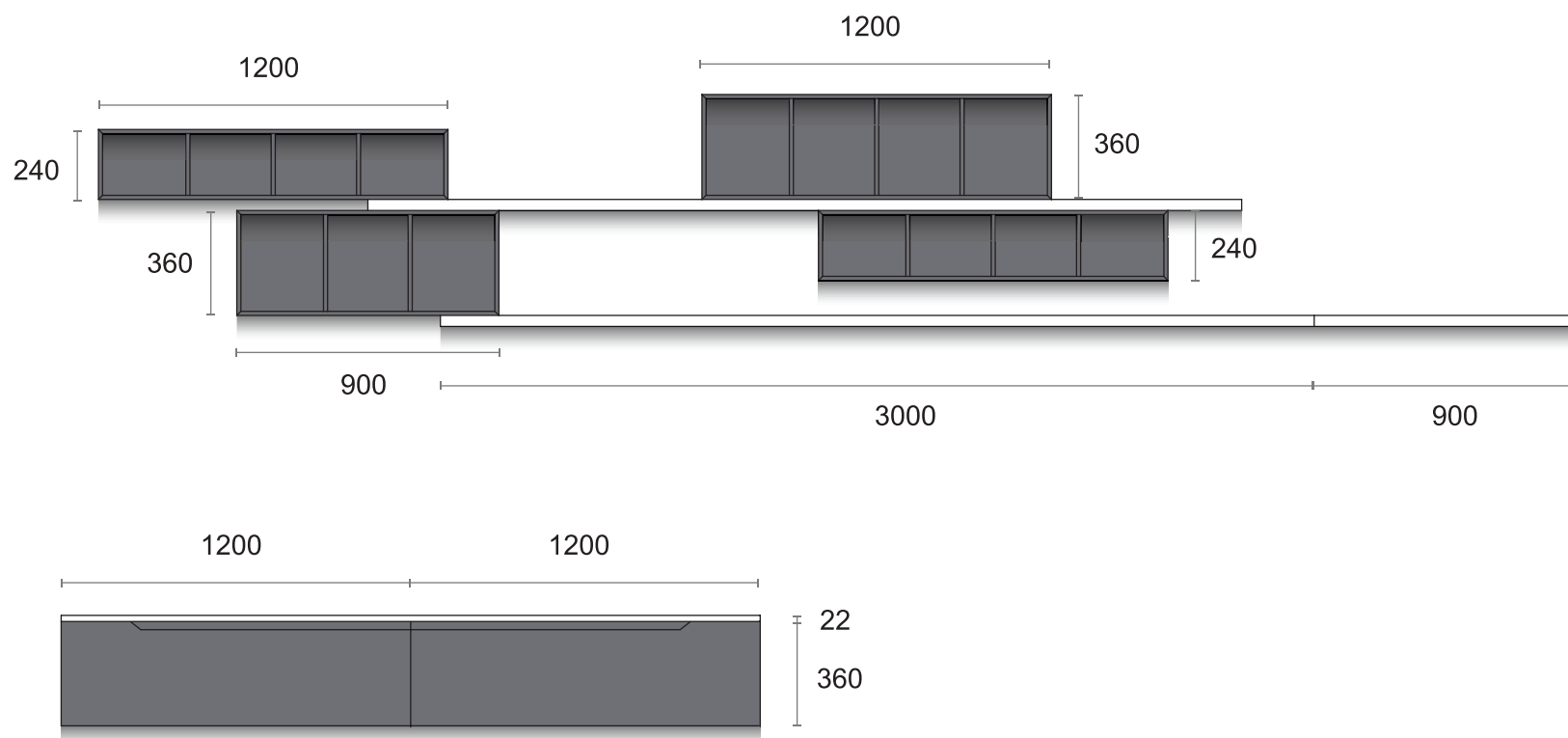

NR. ELEMENTI	DESCRIZIONE	CODICE
2	Elemento a giorno L 120 H 24 P 31 4 vani impiallacciato	E7702708
1	Elemento a giorno L 120 H 36 P 31 4 vani impiallacciato	E7702713
1	Elemento a giorno L 90 H 36 P 31 3 vani impiallacciato	E7702712
1	Base living sospesa L 120 H 36 P 50,4 1 cestone con presa sagomata, 1 fianco come anta	EBL76200
1	Base living sospesa L 120 H 36 P 50,4 1 cestone con presa sagomata	EBL76200
2	Mensola laccata L 300 P 31 SP. 3,8	al ml 091733
1	Mensola laccata L 90 P 31 SP. 3,8	al ml 091733
1	Top laccato L 240 P 50,4 SP. 2,2	al ml TLC225
No. of ELEMENTS	DESCRIPTION	CODE
2	Veneered open unit W 120 H 24 D 31 4 compartments	E7702708
1	Veneered open unit W 120 H 36 D 31 4 compartments	E7702713
1	Veneered open unit W 90 H 36 D 31 3 compartments	E7702712
1	Hanging living base unit W 120 H 36 D 50,4 1 deep drawer with shaped handle, side same as door	EBL76200
1	Hanging living base unit W 120 H 36 D 50,4 1 deep drawer with shaped handle	EBL76200
2	Lacquered shelf W 300 D 31 Th.3,8	per lm 091733
1	Lacquered shelf W 90 D 31 Th.3,8	per lm 091733
1	Lacquered worktop W 240 D 50,4 Th.2,2	per lm TLC225

LIVING LL 05



ANTA
door

ELEMENTI A GIORNO
open units

STRUTTURA
carcass

IMPIALLACCIATO
veneered



LACCATO OPACO
matt lacquered



NOBILITATO
melamine-coated

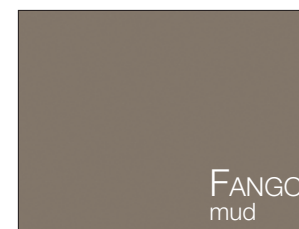

LIVING LL 05

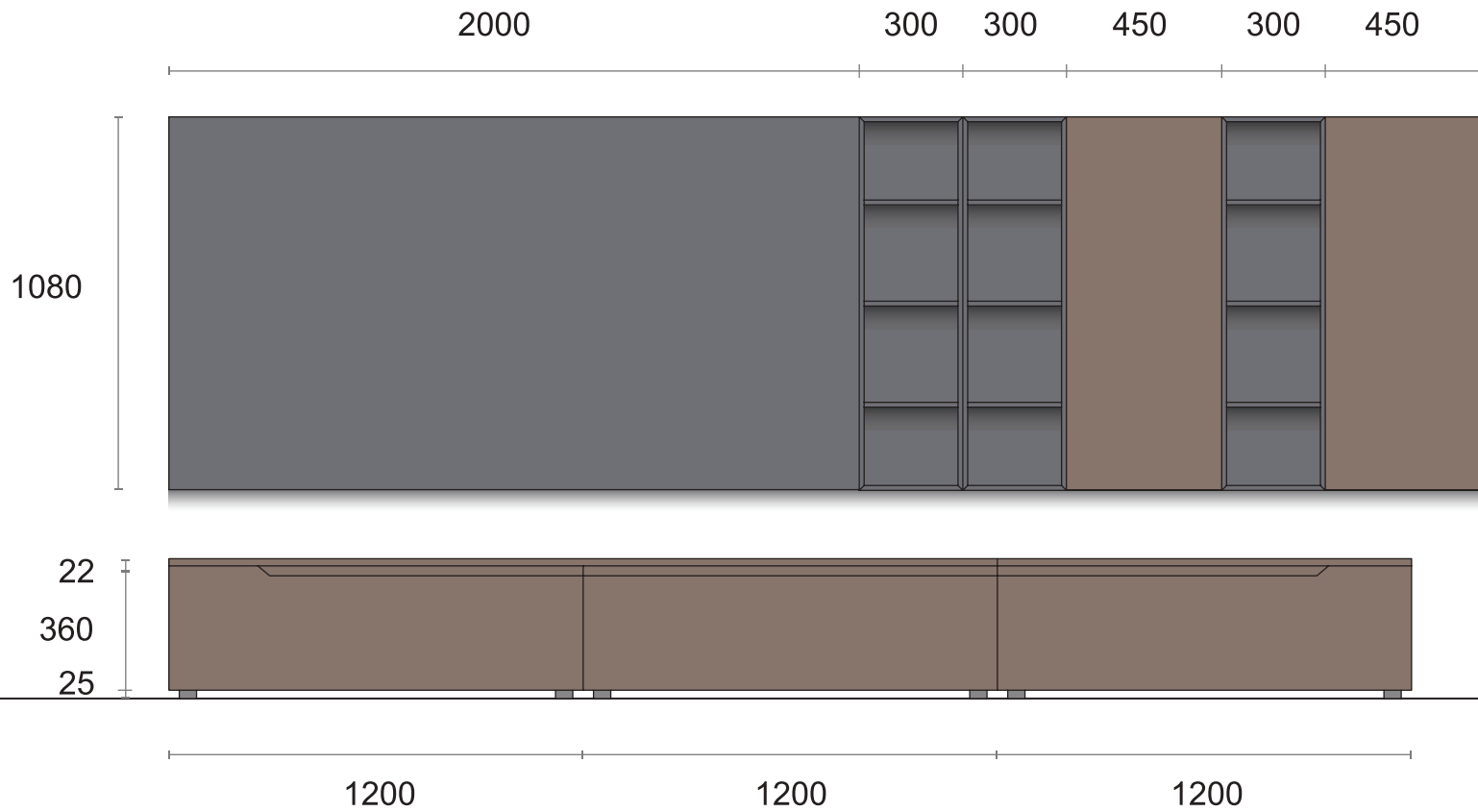

NR. ELEMENTI	DESCRIZIONE	CODICE
1	Pensile L 45 H 108 P 33,4 apertura DX/SX	E2144451/2
1	Pensile L 45 H 108 P 33,4 apertura DX/SX, 1 fianco come anta	E2144451/2
3	Elemento a giorno L 30 H 108 P 31 4 vani, laccato opaco	E7701738
2	Base living L 120 H 38,5 P 50,4 1 cestone con presa sagomata, 1 fianco come anta	EBL26200
1	Base living L 120 H 38,5 P 50,4 1 cestone	EBL26200
1	Pannello di finitura L 200 H 108 SP. 2,2 laccato opaco	al mq 094532
1	Top impiallacciato L 240 P 50,4 SP. 2,2	al ml TLH225
1	Top impiallacciato L 120 P 50,4 SP. 2,2	al ml TLH225
1	Asta appendipensili ml 2	08610501
No. of ELEMENTS	DESCRIPTION	CODE
1	Wall unit W 45 H 108 D 33,4 RH/LH opening	E2144451/2
1	Wall unit W 45 H 108 D 33,4 RH/LH opening side same as door	E2144451/2
3	Matt lacquered open unit W 30 H 108 D 31 4 compartments	E7701738
2	Living base unit W 120 H 38,5 D 50,4 1 deep drawer with shaped handle, side same as door	EBL26200
1	Living base unit W 120 H 38,5 D 50,4 1 deep drawer	EBL26200
1	Matt lacquered finishing panel W 200 H 108 Th.2,2	per m ² 094532
1	Veneered worktop W 240 D 50,4 Th.2,2	per lm TLH225
1	Veneered worktop W 120 D 50,4 Th.2,2	per lm TLH225
1	Wall unit fixing strip lm 2	08610501

LIVING LL 06



ANTE
doors

LACCATO OPACO
matt lacquered



CENERE
ash

IMPIALLACCIATO
veneered



ROVERE GRIGIO REALE
royal grey oak

STRUTTURA
carcass

NOBILITATO
melamine-coated



BIANCO
white

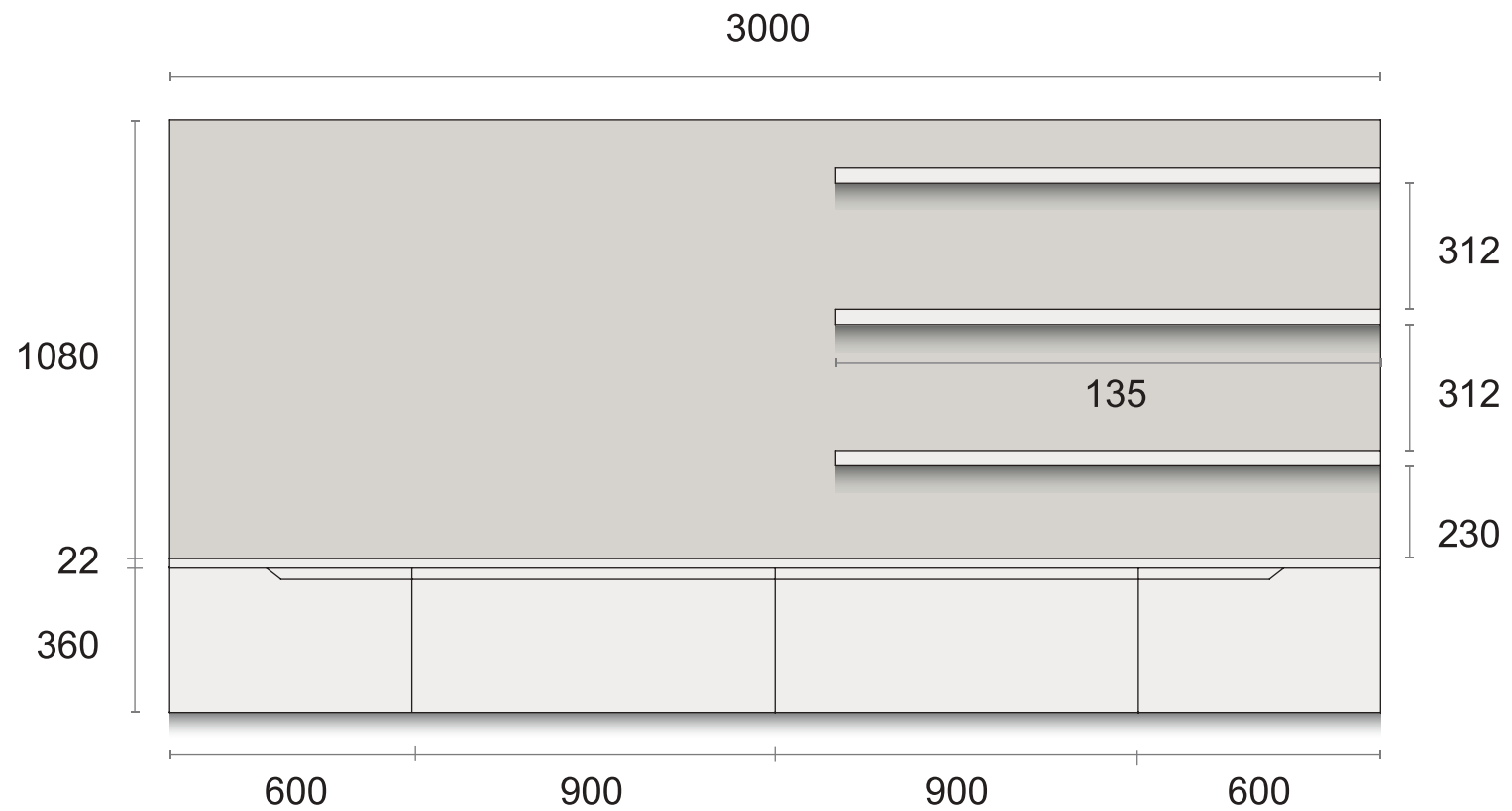

NR. ELEMENTI	DESCRIZIONE	CODICE
2	Base living sospesa L 60 H 36 P 50,4 1 cestone con presa sagomata	EBL75600
2	Base living sospesa L 90 H 36 P 50,4 1 cestone	EBL75900
3	Mensola laccata L 135 P 31 SP. 3,8	al ml 091733
2	Coprifianco laccato H 36 P 48 colore come anta	T983382
1	Pannello di finitura impiallacciato L 300 H 108 SP. 2,2	al mq 094524
1	Top laccato L 300 P 50,4 SP. 2,2	al ml TLC225
No. of ELEMENTS	DESCRIPTION	CODE
2	Hanging living base unit W 60 H 36 D 50,4 1 deep drawer with shaped handle	EBL75600
2	Hanging living base unit W 90 H 36 D 50,4 1 deep drawer	EBL75900
3	Lacquered shelf W 135 D 31 Th.3,8	per lm 091733
2	Lacquered side panel H 36 D 48 same colour as door	T983382
1	Veneered finishing panel W 300 H 108 Th.2,2	per m ² 094524
1	Lacquered worktop W 300 D 50,4 Th.2,2	per lm TLC225

LIVING A SPALLA LL 07



ANTE
doors

LACCATO OPACO
matt lacquered

BIANCO ASSOLUTO
absolute white

IMPIALLACCIATO
veneered

ROVERE NATUR
natur oak

STRUTTURE
carcasses

NOBILITATO
melamine-coated

BIANCO
white

LACCATO OPACO
matt lacquered

BIANCO
white

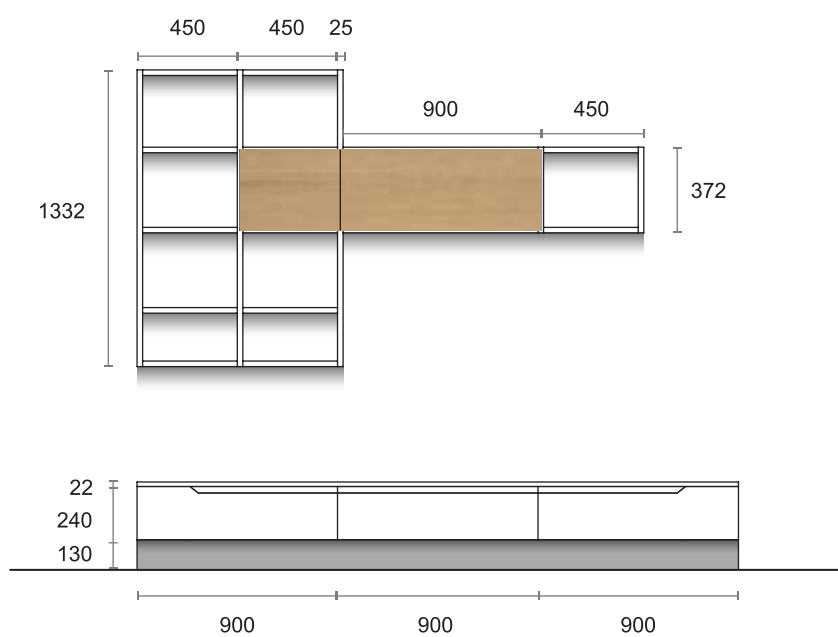

LIVING A SPALLA LL 08



ANTE
doors

LACCATO OPACO
matt lacquered

BIANCO ASSOLUTO
absolute white

IMPIALLACCIATO
veneered

ROVERE MORESCO
moorish oak

STRUTTURE
carcasses

NOBILITATO
melamine-coated

FANGO
mud

LACCATO OPACO
matt lacquered

BIANCO
white

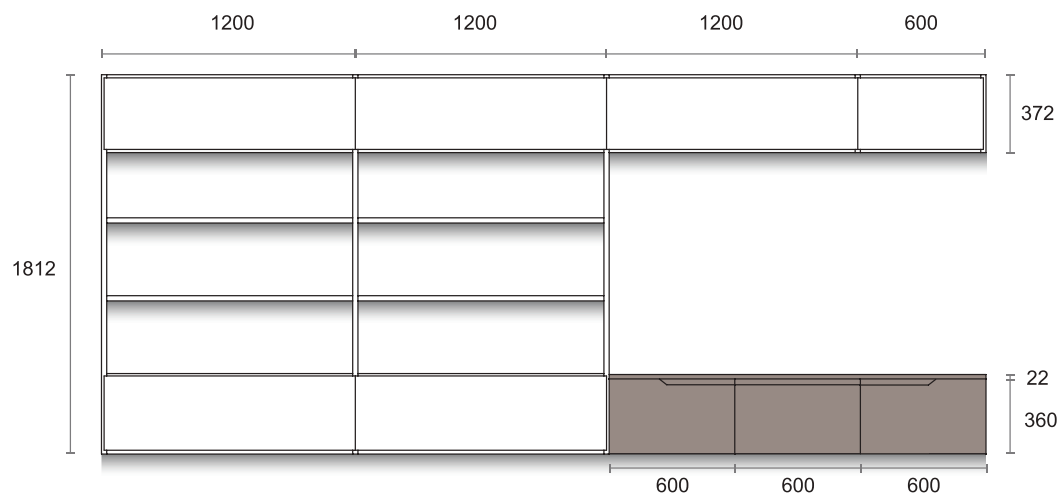

LIVING A SPALLA LL 09



ANTE
doors

IMPIALLACCIATO
veneered



STRUTTURE
carcasses

NOBILITATO
melamine-coated



LACCATO OPACO
matt lacquered

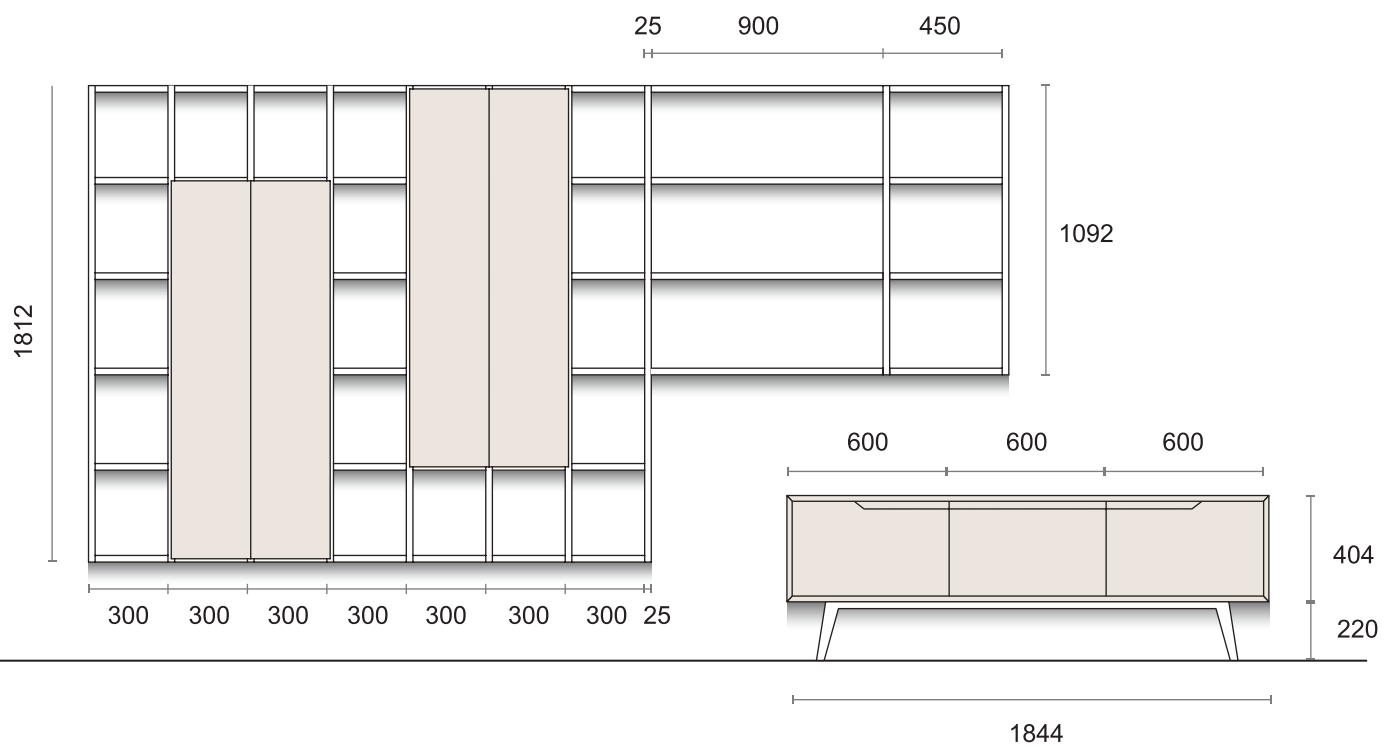

LIVING A SPALLA LL 10



ANTE
doors

LACCATO OPACO
matt lacquered



IMPIALLACCIATO
veneered

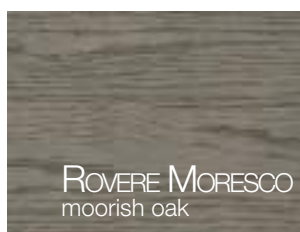

STRUTTURE
carcasses

NOBILITATO
melamine-coated

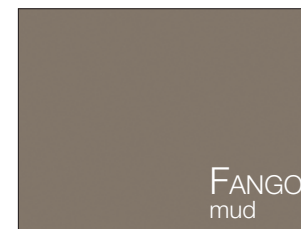

LACCATO OPACO
matt lacquered

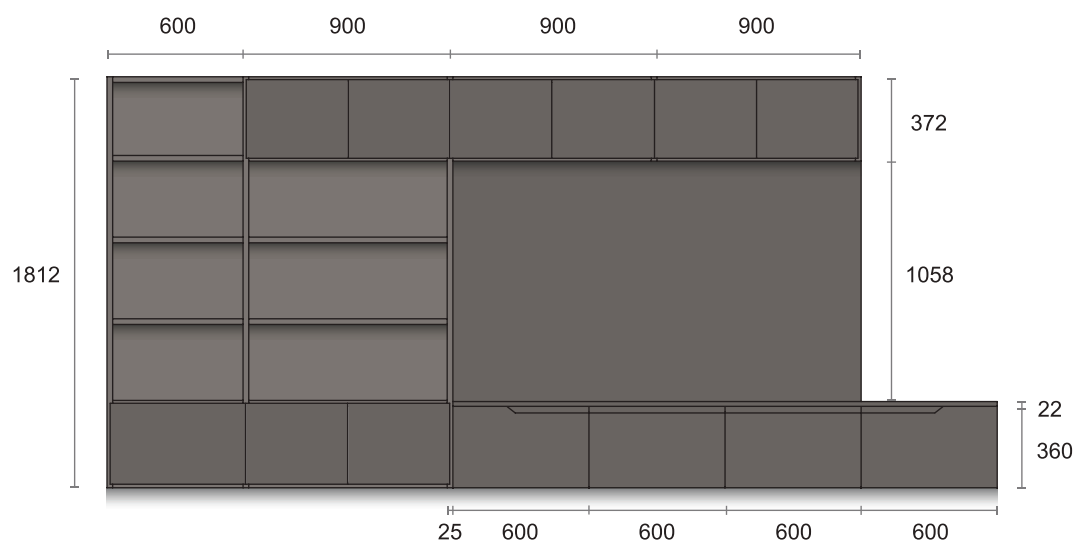
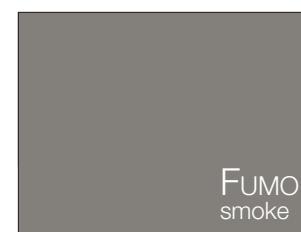

COMPOSIZIONE L 300

COMPOSITION W 300



COMPOSIZIONE L 420

COMPOSITION W 420



COMPOSIZIONE L 300

COMPOSITION W 300

COMPONENTI

COMPONENTS

Colonna 60 H 217 frigo-freezer 315 classe A+

60 cm column H 217 fridge-freezer 315 class "A+"

Base 60 2 cassette e cestone

60 cm base unit with 2 drawers and deep drawer

Base 60 forno multifunzione inox

60 cm base unit for stainless steel multifunctional oven

Piano cottura 60 4 gas inox con valvola

60 cm stainless steel hob with 4 burners with safety valve

Base 60

60 cm base unit

Sottolavello 60

60 cm sink unit

Lavello ad incasso 86 x 50 1 vasca inox

86x50 cm built-in sink with 1 stainless steel bowl

Top 240 P 61 in laminato H 4 bordo ABS1

240 cm laminate worktop D 61 H 4 with ABS1 edge

Pensile 60 H 72

60 cm wall unit H 72

Cappa 60 "Mod.29"

60 cm "Mod.29" hood

Pensile 60 H 72

60 cm wall unit H 72

Scolapiatti 60 H 72

60 cm plate rack H 72

Asta appendipensili ml 4

4 lm wall unit fixing strip

(Elettrodomestici Hotpoint)

(Hotpoint appliances)

COMPOSIZIONE L 420

COMPOSITION W 420

COMPONENTI

COMPONENTS

Colonna 60 H 217 frigo-freezer 315 classe A+

60 cm column H 217 fridge-freezer 315 class "A+"

Colonna 60 H 217 forno multifunzione inox

60 cm column H 217 for stainless steel multifunctional oven

Base 60

60 cm base unit

Piano cottura 75 5 gas inox con valvola

75 cm stainless steel hob with 5 burners with safety valve

Base 90 2 cassette e cestone predisposta piano cottura

90 cm base unit with 2 drawers and deep drawer configured for hob

Base 60

60 cm base unit

Sottolavello 90

90 cm sink unit

Lavello ad incasso 86 x 50 1 vasca inox

86x50 cm built-in sink with 1 stainless steel bowl

Top 300 P 61 in laminato H 4 bordo ABS1

300 cm laminate worktop D 61 H 4 with ABS1 edge

Pensile 60 H 72

60 cm wall unit H 72

Cappa 90 "STILO" inox

90 cm "STILO" stainless steel hood

Pensile 60 H 72

60 cm wall unit H 72

Scolapiatti 90 H 72

90 cm plate rack H 72

Asta appendipensili ml 4

4 lm wall unit fixing strip

(Elettrodomestici Hotpoint)

(Hotpoint appliances)