

# OLTRE



## FINITURE MATERICHE TEXTURED FINISHES

Rigorosa nella sua linearità ma ricca nella sua essenza Oltre presenta, finiture particolari ed accessori che la rendono assolutamente unica nel suo genere. I colori ed i materiali sono tanti e studiati per essere abbinati elegantemente insieme, raffinati e pregiati come le ante realizzate con malta stesa a mano, con effetto cemento, oppure in legno impiallacciato dalla forte tattilità. Caratterizzata dalla meticolosa cura del dettaglio e da un'ampia modularità, Oltre diventa protagonista anche nello spazio living e dining con esclusive soluzioni arredative di design.

Oltre offers rigorous lines and a rich essence, with many different finishes, details and accessories that make it unique in its genre. There are many colours and materials available, all designed to blend together elegantly to create a refined and exclusive look, such as doors with cement-effect hand-applied mortar and those with highly tactile wood veneer. Characterised by a meticulous attention to detail and a high level of modularity, Oltre is also a star of the living room and dining area, offering exclusive designer furnishing solutions.

L'ANTA QUADRATA SI ABBINA ALLA GOLA AD "ELLE" PER CREARE LA COLLEZIONE NECK. UN' ANTA PRESENTATA IN UN' AMPIA GAMMA DI COLORI E FINITURE CHE POSSONO PERSONALIZZARE LA GOLA.

THE SQUARE DOOR MATCHES WITH THE "L" FINGER RAIL OPENING TO CREATE THE NECK COLLECTION. THE DOOR IS PRESENTED ON A WIDE RANGE OF COLOURS AND FINISHES THAT CAN CUSTOMIZE THE FINGER RAIL OPENING.

# OLTRE

## Neck

ANTA QUADRATA  
CON MANIGLIA A GOLA  
SQUARE DOOR WITH FINGER  
RAIL OPENING



L'ERGONOMIA DELLA FORMA DELL'ANTA CARATTERIZZA LA COLLEZIONE LUX. L'ANTA CON PROFILO INCLINATO IN CORRISPONDENZA DELLA GOLA, OFFRE UNA PRESA ED UN'APERTURA MIGLIORI. L'ANTA PUO' ESSERE DOTATA DI UN PROFILO DI PROTEZIONE COORDINATO ALLE FINITURE E COLORI DELLA GOLA.

THE LUX COLLECTION IS CHARACTERIZED BY THE DOORS ERGONOMIC FORM. THE DOOR WITH AN INCLINED PROFILE NEAR THE FINGER RAIL OPENING SYSTEM, OFFERS THE BEST POSSIBLE GRIP AND OPENING. THE DOOR MAY BE EQUIPPED WITH A PROTECTION PROFILE COORDINATED WITH THE FINGER RAIL OPENING SYSTEM FINISHES AND COLOURS.

# OLTRE

## LUX

ANTA INCLINATA  
CON MANIGLIA A GOLA  
INCLINED DOOR WITH FINGER  
RAIL OPENING



# APERTURA CON GOLLA OPENING BY FINGER RAIL

Neck

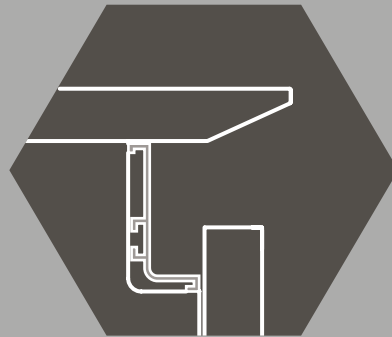

GOLA TIPO "ELLE"  
"ELLE" TYPE FINGER RAIL

ANTA SQUADRATA  
DOOR SQUARED

LUX

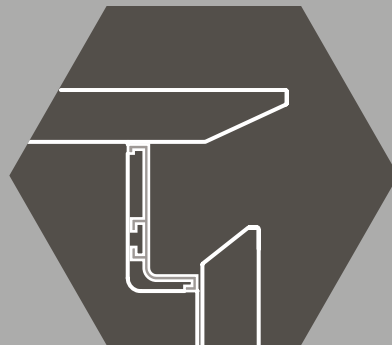

GOLA TIPO "ELLE"  
"ELLE" TYPE FINGER RAIL

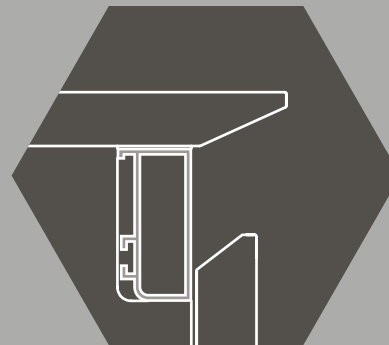

GOLA PIATTA  
FLAT FINGER RAIL

ANTA INCLINATA  
SENZA PROFILO  
INCLINED EDGE DOOR  
WITHOUT PROFILE

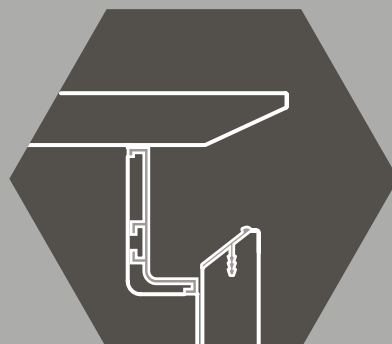

GOLA TIPO "ELLE"  
"ELLE" TYPE FINGER RAIL

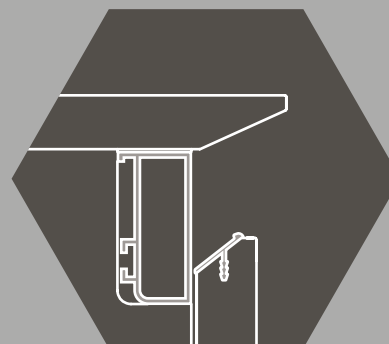

GOLA PIATTA  
FLAT FINGER RAIL

ANTA INCLINATA  
CON PROFILO  
ALLUMINIO  
(OPZ. PI + COD. COLORE)  
INCLINED EDGE DOOR  
WITH ALUMINIUM PROFILE



FINITURE GOLE SPAZZOLATE DISPONIBILI SOLO PER GOLA TIPO "ELLE"  
 MATT FINGER RAILS BRUSHED FINISHES, AVAILABLE ONLY FOR "ELLE" TYPE FINGER RAIL



FINITURE GOLE E PROFILO SPAZZOLATI  
 FINGER RAILS AND PROFILE BRUSHED FINISHES



N.B.: ABBINAMENTO CONSIGLIATO  
 CON L'ANTA BRONZO BRUNITO  
 NOTE: BEST MATCHING WITH THE  
 BURNISHED BRONZE DOOR









\* opz. 412 brill non disponibile per profili

FINITURE GOLE E PROFILO VERNICIATI A POLVERE OPACHI  
 MATT FINGER RAILS AND PROFILE POWDER COATED FINISHES

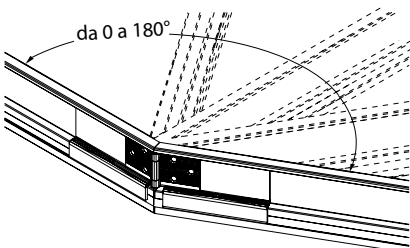

# GOLA "ELLE" ORIZZONTALE SOTTOTOP

UNDERMOUNT HORIZONTAL "ELLE" FINGER RAIL





	COD.			COD.		
<p><b>Gola sottotop tipo "A"</b> Type "A" undermount finger rail</p>  <p style="text-align: right;"><b>al ml</b> per lm</p>	G950010			<p><b>Angolo interno a 90° per gola tipo "A"</b> 90° interior corner for "A" type finger rail</p>  <p style="text-align: right;"><b>cadauno</b> each</p>	G950050	
<p><b>Terminale aperto dx o sx per gola tipo "A" da utilizzare a fine composizione</b> RH or LH open end for type "A" finger rail to be placed at the end of the composition</p>  <p style="text-align: right;"><b>terminale DX</b> RH end</p> <p style="text-align: right;"><b>terminale SX</b> LH end</p>	G950021			<p><b>Angolare con snodo per unione fuori squadra per gola tipo "A"</b> Corner piece with joint for out-of-plumb joining for type "A" finger rail</p>  		
<p><b>Terminale chiuso dx o sx per gola tipo "A" da utilizzare solo tra basi e colonne</b> RH or LH closure for type "A" finger rail to be placed only between base units and column</p>  <p style="text-align: right;"><b>terminale DX</b> RH end</p> <p style="text-align: right;"><b>terminale SX</b> LH end</p>	G950031					
<p><b>Terminale chiuso dx o sx per gola tipo "A" da utilizzare solo tra basi e colonne</b> RH or LH closure for type "A" finger rail to be placed only between base units and column</p>  <p style="text-align: right;"><b>terminale DX</b> RH end</p> <p style="text-align: right;"><b>terminale SX</b> LH end</p>	G950032					G950060
<p><b>Coppia angolari per kit raccordo base angolo 110x110</b> Couple corner piece for fitting kit corner base unit 110x110</p>  <p style="text-align: center;">SX LH                      DX RH</p> <p style="text-align: right;"><b>in alluminio</b> aluminium</p> <p style="text-align: right;"><b>angolare DX</b> RH corner piece</p> <p style="text-align: right;"><b>angolare SX</b> LH corner piece</p>	G950058					
	G950059					





# GOLA "ELLE" ORIZZONTALE INTERMEDIA

INTERMEDIATE HORIZONTAL "ELLE" FINGER RAIL

# GOLE "ELLE" VERTICALI PER COLONNE

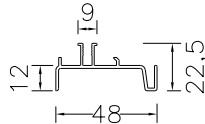
VERTICAL "ELLE" FINGER RAILS FOR COLUMNS

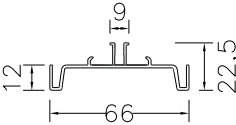
	COD.	
<p><b>Gola intermedia tipo "B"</b> Type "B" intermediate finger rail</p>  <p style="text-align: right;"><b>al ml</b> per lm</p>	G950110	
<p><b>Terminale aperto dx o sx per gola tipo "B" da utilizzare a fine composizione</b> RH or LH open end for type "B" finger rail to be placed at the end of the composition</p>  <p style="text-align: right;"><b>terminale DX</b> RH end <b>terminale SX</b> LH end</p>	G950121 G950122	
<p><b>Terminale chiuso dx o sx per gola tipo "B" da utilizzare solo tra cassettiere e lavastoviglie/colonne</b> RH or LH closure for type "B" finger rail to be placed only between drawer units and dishwasher/columns</p>  <p style="text-align: right;"><b>terminale DX</b> RH end <b>terminale SX</b> LH end</p>	G950131 G950132	
<p><b>Angolo interno a 90° per gola tipo "B"</b> 90° interior corner for "B" type finger rail</p>  <p style="text-align: right;"><b>cadauno</b> each</p>	G950150	

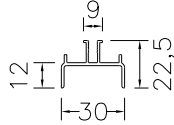
	COD.	
<p><b>Mezza gola verticale tipo "C" (completa di distanziale)</b> Type "C" half vertical finger rail (complete with spacer)</p>   <p style="text-align: center;"><b>sezione mezza gola tipo "C"</b> cross section of type "C" finger rail</p> <p><b>Piedi H 13</b> H 96 H 132 H 204 H 228</p> <p><b>Piedi H 6</b> H 108 H 144 H 216</p>	G950310 G950330 G950350 G950370 G950320 G950340 G950360	
<p><b>Gola verticale intermedia tipo "D" (completa di distanziale)</b> Type "D" intermediate vertical finger rail (complete with spacer)</p>   <p style="text-align: center;"><b>sezione gola tipo "D"</b> cross section of type "D" finger rail</p> <p><b>Piedi H 13</b> H 96 H 132 H 204 H 228</p> <p><b>Piedi H 6</b> H 108 H 144 H 216</p>	G950410 G950430 G950450 G950470 G950420 G950440 G950460	
<p><b>Gola verticale laterale tipo "E" (completa di distanziale)</b> Type "E" lateral vertical finger rail (complete with spacer)</p>   <p style="text-align: center;"><b>sezione gola tipo "E"</b> cross section of type "E" finger rail</p> <p><b>Piedi H 13</b> H 96 H 132 H 204 H 228</p> <p><b>Piedi H 6</b> H 108 H 144 H 216</p>	G950510 G950530 G950550 G950570 G950520 G950540 G950560	

# NOZIONI UTILI - gole "elle" orizzontali per basi

USEFUL INFORMATION - HORIZONTAL "ELLE" FINGER RAILS FOR BASE UNITS

## VISTA FRONTALE ZOCCOLO H 6 PER BASI H 90

FRONT VIEW PLINTH H 6 FOR BASE UNITS H 90

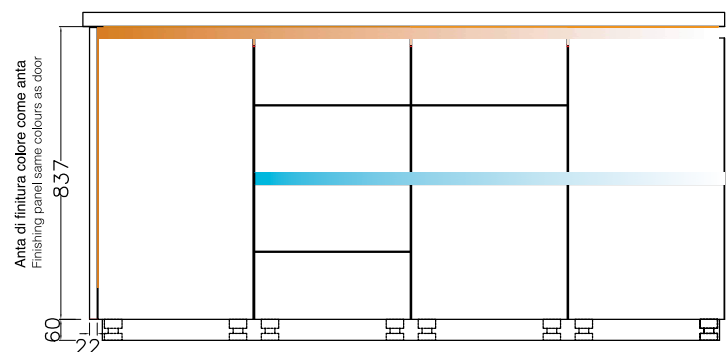
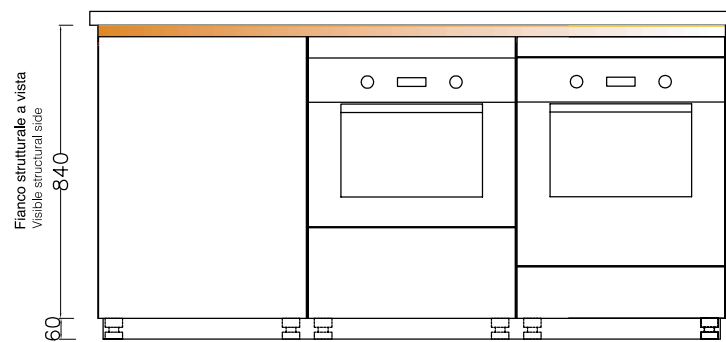

## VISTA LATERALE (sezione) ZOCCOLO H 6 PER BASI H 90

SIDE VIEW (CROSS SECTION) PLINTH H 6 FOR BASE UNITS H 90

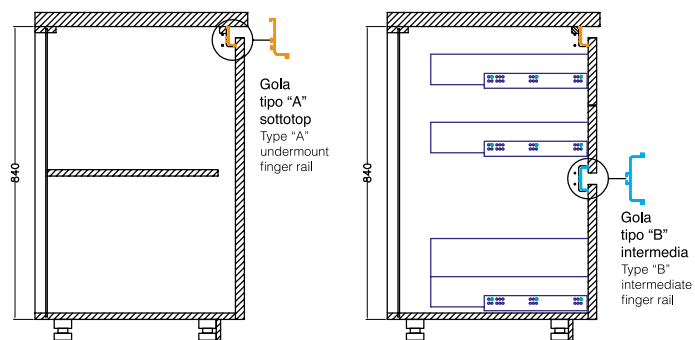

## VISTA DALL'ALTO

TOP VIEW

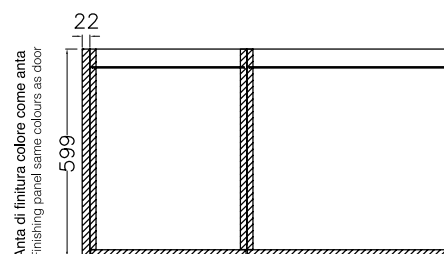
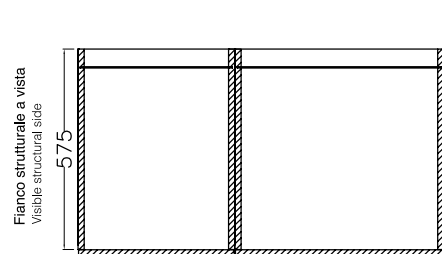

Composizione con ante di finitura laterali: alla dimensione finale della cucina, sommare sempre lo spessore delle ante di finitura (ogni anta 2,2 cm)

Composition with side finishing panels: to the final size of the kitchen, always add the thickness of the finishing panels (each panel 22 mm)



# NOZIONI UTILI - gole "elle" verticali per colonne

USEFUL INFORMATION - VERTICAL "ELLE" FINGER RAILS FOR COLUMNS

## VISTA FRONTALE ZOCCOLO H 6

FRONT VIEW PLINTH H 6

**N.B.: per la versione Lux sulle colonne il profilo anta è sempre inclinato verticale**

**Note: door always with vertical inclined profile for the Lux versions' columns**

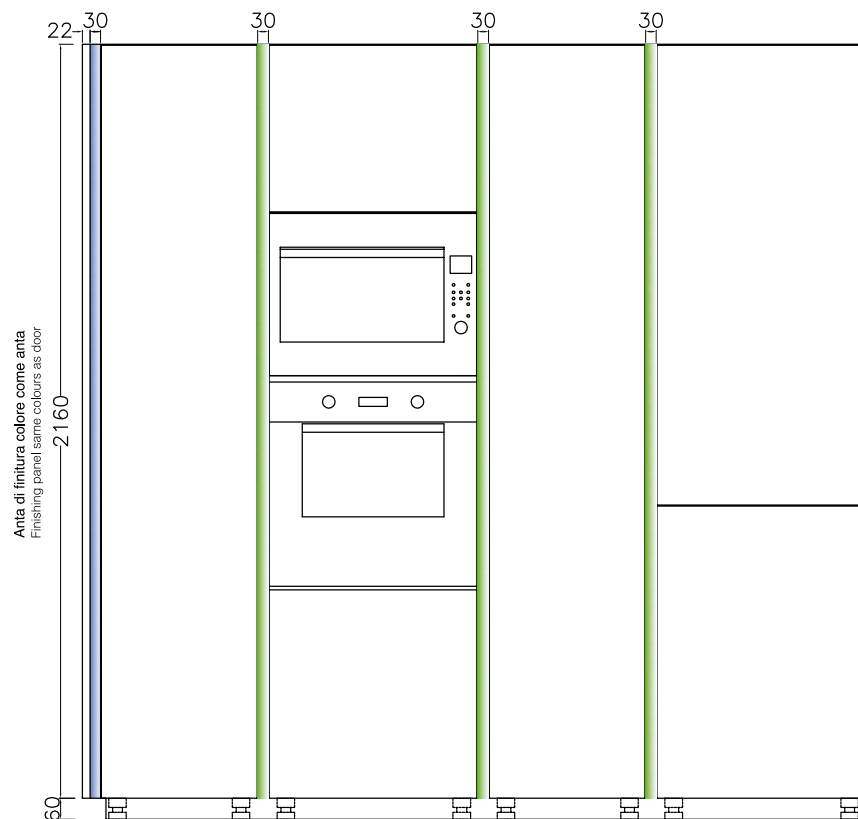

## VISTA DALL'ALTO

TOP VIEW

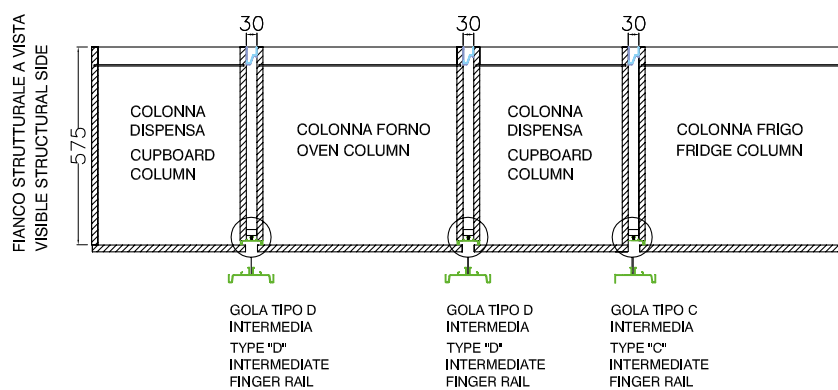

Composizione fianco strutturale a vista come anta: alla dimensione finale della cucina, sommare sempre lo spessore dei distanziali tra le colonne (ogni distanziale 3 cm)

Composition with visible side panel to match door: to the final size of the kitchen, always add the thickness of the spacers between the two columns (each spacer 3 cm)

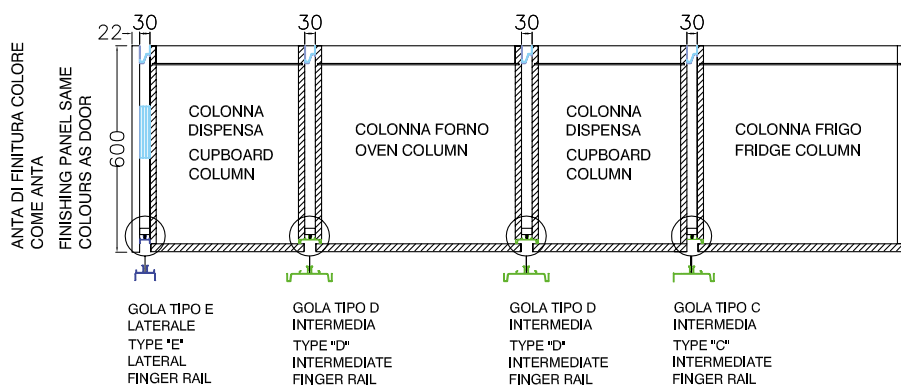





Composizione con ante di finitura laterali, alla dimensione finale della cucina, sommare sempre lo spessore dei distanziali tra le colonne (ogni distanziale 3 cm) e lo spessore delle ante di finitura (ogni anta 2,2 cm)

Composition with side finishing panels to the final size of the kitchen, always add the thickness of the spacer between the two columns (each spacer 3 cm) and the thickness of the finishing panels (each panel 22 mm)

# GOLA PIATTA ORIZZONTALE SOTTOTOP

UNDERMOUNT HORIZONTAL **FLAT** FINGER RAIL

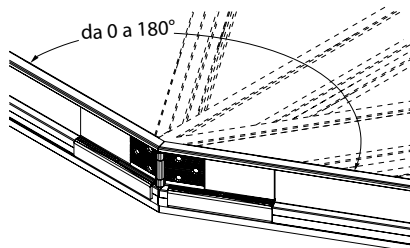
	COD.			COD.	
<p><b>Gola piatta sottotop tipo "AP"</b> Type "AP" undermount flat finger rail</p> 				<p><b>Angolo interno a 90° per gola tipo "AP"</b> 90° interior corner for "AP" type finger rail</p> 	
	al ml per lm	G960010		cadauno each	G960050
<p><b>Terminale chiuso "T1" dx o sx per gola tipo "AP" da utilizzare a fine composizione</b> "T1" RH or LH closure for type "AP" finger rail to be placed at the end of the composition</p> 				<p><b>Angolare con snodo per unione fuori squadra per gola tipo "AP"</b> Corner piece with joint for out-of-plumb joining for type "AP" finger rail</p> 	
	<b>terminale DX</b> RH end	G960021			
	<b>terminale SX</b> LH end	G960022			
<p><b>Terminale chiuso "T2" dx o sx per gola tipo "AP" da utilizzare solo tra basi e colonne</b> "T2" RH or LH closure for type "AP" finger rail to be placed only between base units and column</p> 				 <p>da 0 a 180°</p>	
	<b>terminale DX</b> RH end	G960031			
	<b>terminale SX</b> LH end	G960032			
					G950060



# NOZIONI UTILI - gole orizzontali **piatte** per basi

USEFUL INFORMATION - HORIZONTAL **FLAT** FINGER RAILS FOR BASE UNITS

## VISTA FRONTALE ZOCCOLO H 6 PER BASI H 90

FRONT VIEW PLINTH H 6 FOR BASE UNITS H 90

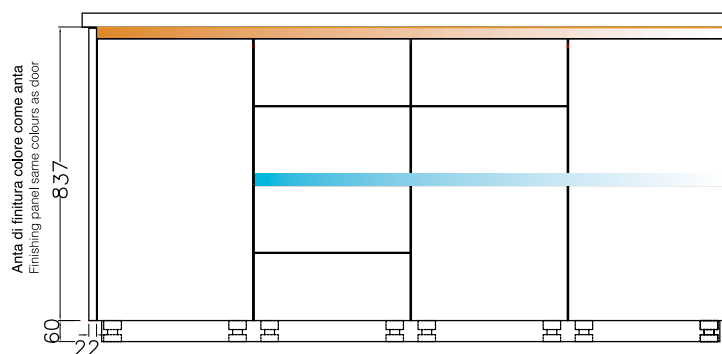
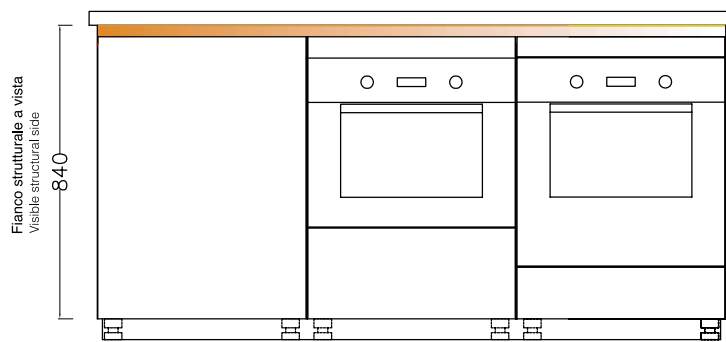

## VISTA LATERALE (sezione) ZOCCOLO H 6 PER BASI H 90

SIDE VIEW (CROSS SECTION) PLINTH H 6 FOR BASE UNITS H 90

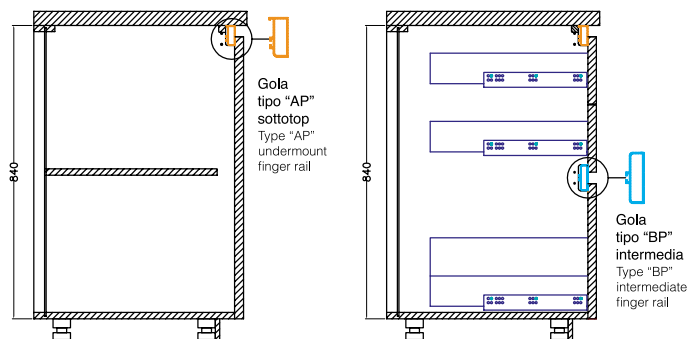

## VISTA DALL'ALTO

TOP VIEW

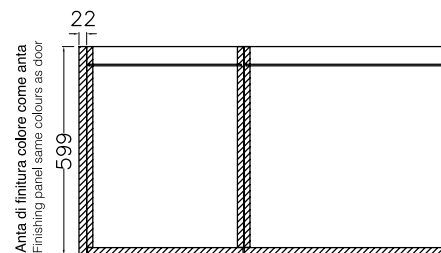
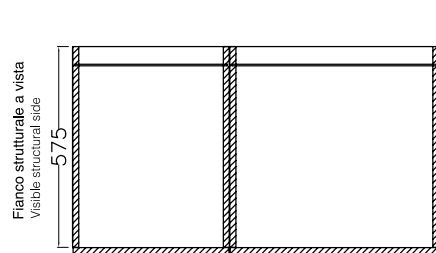

Composizione con ante di finitura laterali: alla dimensione finale della cucina, sommare sempre lo spessore delle ante di finitura (ogni anta 2,2 cm)

Composition with side finishing panels: to the final size of the kitchen, always add the thickness of the finishing panels (each panel 22 mm)

# NOZIONI UTILI - gole verticali **piatte** per colonne

USEFUL INFORMATION - VERTICAL **FLAT** FINGER RAILS FOR COLUMNS

## VISTA FRONTALE ZOCCOLO H 6

FRONT VIEW PLINTH H 6

**N.B.:** per la versione Lux sulle colonne il profilo anta è sempre inclinato verticale

Note: door always with vertical inclined profile for the Lux versions' columns

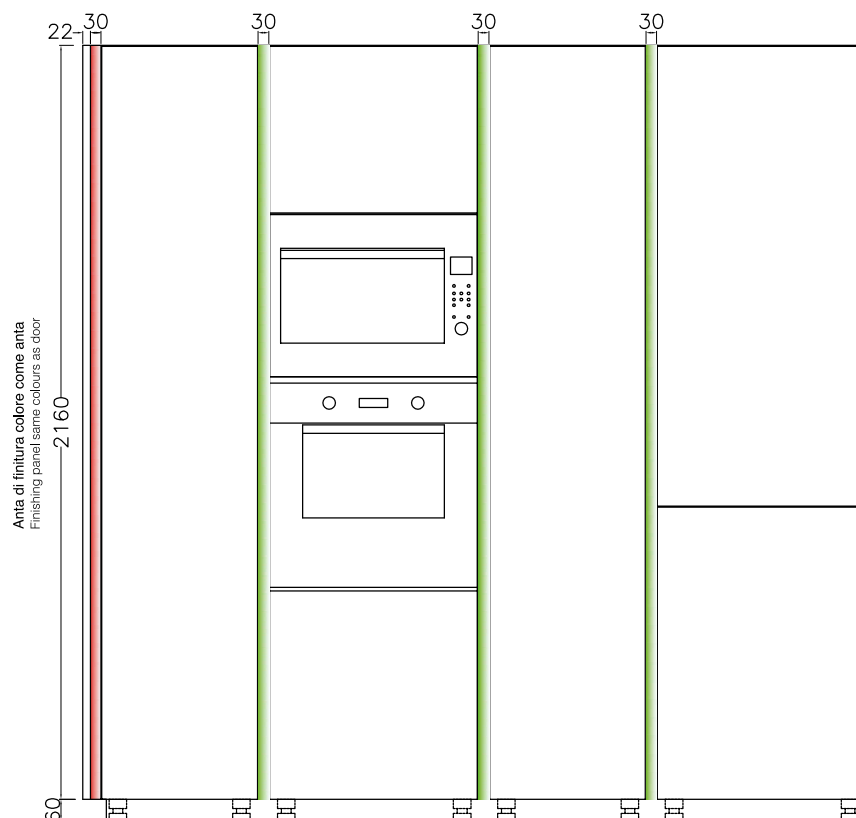

## VISTA DALL'ALTO

TOP VIEW

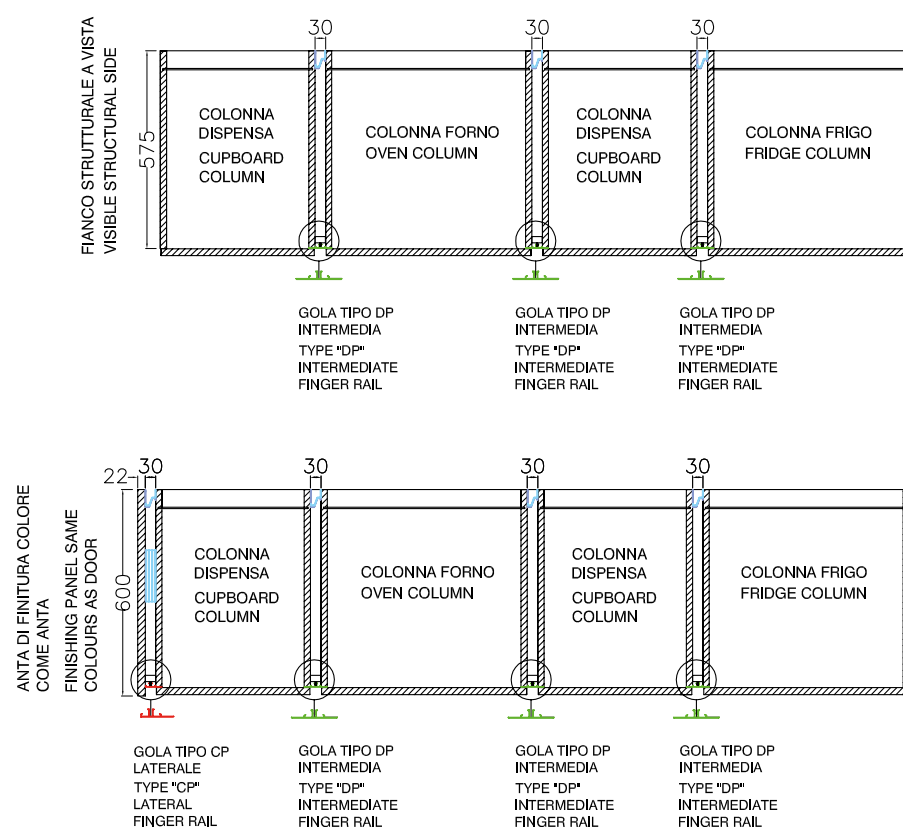

Composizione fianco strutturale  
a vista come anta:  
alla dimensione finale della cucina,  
sommare sempre lo spessore dei  
distanziali tra le colonne  
(ogni distanziale 3 cm)

Composition with visible side panel to match door:  
to the final size of the kitchen, always add the thickness  
of the spacers between the two columns (each spacer 3 cm)

Composizione con ante di finitura  
laterali, alla dimensione finale della  
cucina, sommare sempre lo spessore  
dei distanziali tra le colonne  
(ogni distanziale 3 cm) e lo spessore  
delle ante di finitura (ogni anta 2,2 cm)

Composition with side finishing panels to the final size of the  
kitchen, always add the thickness of the spacer between the  
two columns (each spacer 3 cm) and the thickness of the  
finishing panels (each panel 2,2 mm)

SP. 22 MM

OLTRE **N**eck  
**L**ux

## CARATTERISTICHE TECNICHE

### ANTE E FRONTALI CASSETTI

anta sp.22 mm impiallacciata **rovere vintage con nodi e stuccature venatura verticale finitura materica** nei colori: rovere bianco invecchiato (opz.5380), rovere juta invecchiato (opz.5381), rovere corteccia invecchiato (opz.5382), rovere mielato invecchiato (opz.5383), rovere antracite invecchiato (opz.5384), rovere argilla invecchiato (opz.5385), rovere moro invecchiato (opz.5386), rovere naturale invecchiato parquettato (opz.5387), rovere grigio terra (opz.5389) rovere madera termocotto con finto tarlo (opz.5388)

### VERSIONE **NECK**

anta squadrata, per gola ad "ELLE"



### VERSIONE **LUX** PROFILI E GOLE

di serie: anta profilo inclinata per gola ad "ELLE"  
a richiesta: anta profilo inclinata per gola piatta

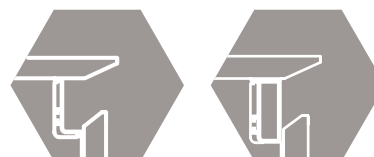

a richiesta: anta profilo alluminio inclinata per gola ad "ELLE"  
anta profilo alluminio inclinata per gola piatta

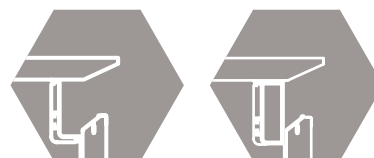

### STRUTTURE

**ANTE: rovere argilla invecchiato**

di serie : nobilitato bianco (opz.001) schiena e ripiano bianco (opz.001)

**ANTE: rovere bianco invecchiato, rovere juta invecchiato**

di serie : nobilitato visone (opz.948M) schiena e ripiano visone (opz.948M)

**ANTE: rovere antracite invecchiato**

di serie : nobilitato lavagna (opz.9620) schiena e ripiano lavagna (opz.9620)

**ANTE: rovere corteccia invecchiato, rovere mielato invecchiato, rovere moro invecchiato,**

**rovere naturale parquettato, rovere madera termocotto, rovere grigio terra**

di serie : nobilitato fango (opz.8860) schiena e ripiano fango (opz.8860)

a richiesta : nobilitato perla d'oriente (opz.940) schiena e ripiano bianco (opz.001)

nobilitato conchiglia (opz.8910) schiena e ripiano conchiglia (opz.8910)

nobilitato argilla (opz.9690) schiena e ripiano argilla (opz.9690)



### MENSOLE

di serie: altezza cm 3,8 in laminato come strutture: bianco (opz.001), perla d'oriente (opz.940), visone (opz.948M), lavagna (opz.9620), fango (opz.8860), argilla (opz.9690), conchiglia (opz.8910)

a richiesta: altezza cm 3,8 impiallacciata finiture come ante

### ZOCCOLI

vedi pag.49



TH. 22 MM

# OLTRE **N**eck **L**UX

## TECHNICAL FEATURES

### DOORS AND DRAWER FRONTS

22 mm th. veneered door **vintage oak with knots and filler vertical grain textured finish** in the following colours: white aged oak (opt.5380), jute aged oak (opt.5381), bark aged oak (opt.5382), honey aged oak (opt.5383), anthracite aged oak (opt.5384), clay aged oak (opt.5385), dark aged oak (opt.5386), parquet-effect natural aged oak (opt.5387) grey earth oak (opt.5389), heat treated madera oak with worm-eaten effect (opt.5388)

### NECK VERSION

square edge door, for "L-SHAPED" finger rail

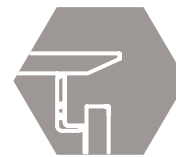

### PROFILES AND FINGER RAILS LUX VERSION

**standard:** inclined edge door, for "L-SHAPED" finger rail  
**on request:** inclined edge door, for flat finger rail

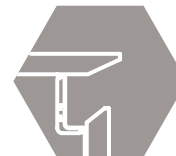

**on request:** aluminium inclined edge door, for "L-SHAPED" finger rail  
aluminium inclined edge door, for flat finger rail

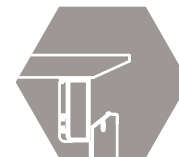
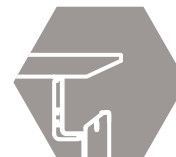

### STRUCTURES

**DOORS: clay aged oak**

**standard:** melamine-coated white (opt.001), white back panel and shelf (opt.001)

**DOORS: white aged oak, jute aged oak**

**standard:** melamine-coated mink (opt.948M), mink back panel and shelf (opt.948M)

**DOORS: anthracite aged oak**

**standard:** melamine-coated slate grey (opt.9620), slate grey back panel and shelf (opt.9620)

**DOORS: bark aged oak, honey aged oak, dark aged oak, parquet-effect natural aged oak, heat treated madera oak, grey earth oak**

**standard:** melamine-coated mud (opt.8860), mud back panel and shelf (opt.8860)

**on request:** melamine-coated oriental pearl (opt.940), white back panel and shelf (opt.001)

melamine-coated shell (opt.8910), shell back panel and shelf (opt.8910)

melamine-coated clay (opt.9690), clay back panel and shelf (opt.9690)

### SHELVES

**standard:** height 3.8 cm, in laminate to match structure: white (opt.001), oriental pearl (opt.940), mink (opt.948M), slate grey (opt.9620), mud (opt.8860), clay (opt.9690), shell (opt.8910)

**on request:** height 3.8 cm, veneered to match doors

### PLINTHS

see page 49

cod.

# G50<sub>Neck</sub> G60<sub>Lux</sub> Impiallacciato Veneered

SP. 22 MM TH. 22 MM

## OLTRE **N**eck **L**UX

anta finitura materica vintage  
door with textured vintage finish



rovere bianco invecchiato  
(opz.5380)  
white aged oak (opt.5380)



rovere juta invecchiato  
(opz.5381)  
jute aged oak (opt.5381)



rovere corteccia invecchiato  
(opz.5382)  
bark aged oak (opt.5382)



rovere mielato invecchiato  
(opz.5383)  
honey aged oak (opt.5383)

**N**eck



particolare anta squadrata  
squared edge door detail



rovere antracite invecchiato  
(opz.5384)  
anthracite aged oak  
(opt.5384)



rovere argilla invecchiato  
(opz.5385)  
clay aged oak (opt.5385)



rovere moro invecchiato  
(opz.5386)  
dark aged oak (opt.5386)



rovere naturale invecchiato  
parquettato (opz.5387)  
parquet-effect natural aged  
oak (opt.5387)

**L**UX



particolare anta inclinata  
inclined edge door detail



particolare anta inclinata  
con profilo alluminio  
inclined edge door with  
aluminium profile detail



rovere maderia termocotto  
con finto tarlo (opz.5388)  
heat treated maderia oak  
with worm-eaten effect  
(opt.5388)



particolare anta con finto tarlo  
door with worm-eaten effect detail



rovere grigio terra (opz.5389)  
grey earth oak (opt.5389)





SP. 22 MM

OLTRE Neck  
LUX

## CARATTERISTICHE TECNICHE

ANTE E FRONTALI  
CASSETTI

anta sp.22 mm con pannello in truciolare E1 rivestito lato esterno con fenix spessore 9/10 lato interno in laminato spessore 9/10 in tinta come esterno, bordata in polipropilene con incollaggio laser spessore 10/10; nella versione Lux con presa maniglia il lato inclinato è bordato in polipropilene spessore 10/10 incollaggio poliuretano nei colori: bianco caldo (opz.7446), castoro (opz.8864), nero (opz.7861), grigio bromo (opz.9628), fumo (opz.9629), cacao orinoco (opz.8865), beige arizona (opz.7705), grigio efeso (opz.9630), blu fes (opz.8301), bianco dover (opz.7449)

VERSIONE **NECK**

anta squadrata, per gola ad "ELLE"

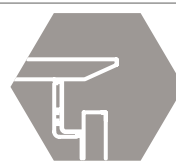
VERSIONE **LUX**  
PROFILI E GOLE

di serie: anta profilo inclinata per gola ad "ELLE"  
a richiesta: anta profilo inclinata per gola piatta

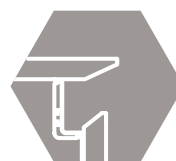

a richiesta: anta profilo alluminio inclinata per gola ad "ELLE"  
anta profilo alluminio inclinata per gola piatta

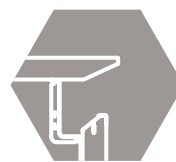

## STRUTTURE

**ANTE: bianco caldo, bianco dover**

di serie : nobilitato bianco (opz.001) schiena e ripiano bianco (opz.001)

**ANTE: fumo, beige arizona**

di serie : nobilitato visone (opz.948M) schiena e ripiano visone (opz.948M)

**ANTE: nero, grigio bromo, blu fes**

di serie : nobilitato lavagna (opz.9620) schiena e ripiano lavagna (opz.9620)

**ANTA: castoro**

di serie : nobilitato conchiglia (opz.8910) schiena e ripiano conchiglia (opz.8910)

**ANTA: cacao orinoco**

nobilitato fango (opz.8860) schiena e ripiano fango (opz.8860)

**ANTA: grigio efeso**

nobilitato argilla (opz.9690) schiena e ripiano argilla (opz.9690)

a richiesta : nobilitato perla d'oriente (opz.940) schiena e ripiano bianco (opz.001)



## MENSOLE

di serie: altezza cm 3,8 in laminato come strutture: bianco (opz.001), perla d'oriente (opz.940), visone (opz.948M), lavagna (opz.9620), fango (opz.8860), argilla (opz.9690), conchiglia (opz.8910)

a richiesta: altezza cm 3,8 finiture come ante

## ZOCOLI

vedi pag.49



TH. 22 MM

# OLTRE Neck LUX

## TECHNICAL FEATURES

### DOORS AND DRAWER FRONTS

22 mm th. door with E1 chipboard panel with exterior coated in 9/10 thickness Fenix and interior in 9/10 thickness laminate in the same colour as the exterior. Edge in 10/10 thickness polypropylene with laser gluing. The Lux version with handle grip has 10/10 thickness polypropylene edging on the inclined side with polyurethane gluing in the following colours: warm white (opt.7446), beaver (opt.8864), black (opt.7861), bromine grey (opt.9628), smoke (opt.9629), cocoa orinoco (opt.8865), arizona beige (opt.7705), ephesus grey (opt.9630), blue fes (opt.8301), dover white (opt.7449)

### NECK VERSION

square edge door, for "L-SHAPED" finger rail



### PROFILES AND FINGER RAILS LUX VERSION

**standard:** inclined edge door, for "L-SHAPED" finger rail  
**on request:** inclined edge door, for flat finger rail

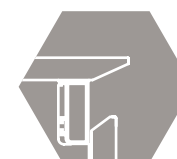
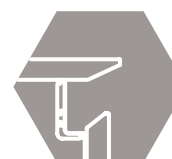

**on request:** aluminium inclined edge door, for "L-SHAPED" finger rail  
aluminium inclined edge door, for flat finger rail

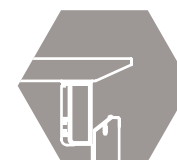
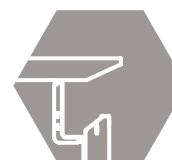

### STRUCTURES

**DOORS: warm white, dover white**  
**standard:** melamine-coated white (opt.001), white back panel and shelf (opt.001)  
**DOORS: smoke, arizona beige**  
**standard:** melamine-coated mink (opt.948M), mink back panel and shelf (opt.948M)  
**DOORS: black, bromine grey, fles blue**  
**standard:** melamine-coated slate grey (opt.9620), slate grey back panel and shelf (opt.9620)  
**DOOR: beaver**  
**standard:** melamine-coated shell (opt.8910), shell back panel and shelf (opt.8910)  
**DOOR: orinoco cocoa**  
**standard:** melamine-coated mud (opt.8860), mud back panel and shelf (opt.8860)  
**DOOR: ephesus grey**  
**standard:** melamine-coated clay (opt.9690), clay back panel and shelf (opt.9690)

**on request:** melamine-coated oriental pearl (opt.940), white back panel and shelf (opt.001)

### SHELVES

**standard:** height 3.8 cm, in laminate to match structure: white (opt.001) oriental pearl (opt.940), mink (opt.948M), slate grey (opt.9620), mud (opt.8860), clay (opt.9690), shell (opt.8910)

**on request:** height 3.8 cm, finished to match doors

### PLINTHS

see page 49

**SP. 22 MM TH. 22 MM**

anta finitura fenix

door with fenix finish

# OLTRE **N**eck **L**UX

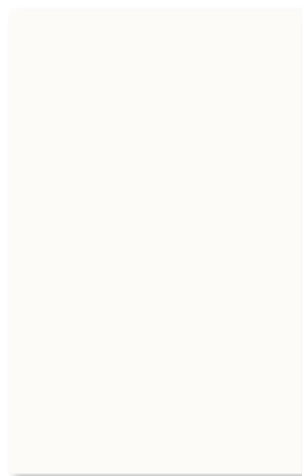

bianco caldo (opz.7446)  
warm white (opt.7446)



castoro (opz.8864)  
beaver (opt.8864)



nero (opz.7861)  
black (opt.7861)



grigio bromo (opz.9628)  
bromine grey (opt.9628)



fumo (opz.9629)  
smoke (opt.9629)



cacao orinoco (opz.8865)  
cocoa orinoco (opt.8865)



beige arizona (opz.7705)  
arizona beige (opt.7705)



grigio efeso (opz.9630)  
ephesus grey (opt.9630)



blu fes (opz.8301)  
blue fes (opt.8301)

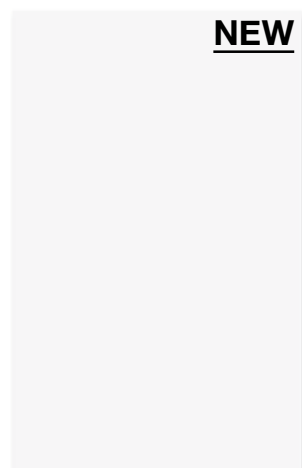

bianco dover (opz.7449)  
dover white (opt.7449)

**N**eck

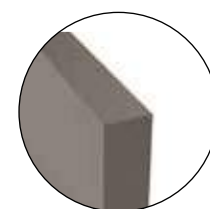

particolare anta squadrata  
squared edge door detail

**L**UX

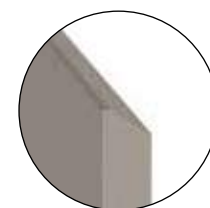

particolare anta inclinata  
inclined edge door detail



particolare anta inclinata  
con profilo alluminio  
inclined edge door with  
aluminium profile detail

# Informazioni tecniche

## FENIX NTM™

È un nuovissimo prodotto per l'interior design sviluppato da Arpa Industriale.

Prodotto grazie a resine di nuova generazione, questo materiale intelligente si contraddistingue per una superficie dalle proprietà straordinarie.

Con una bassa riflessione della luce, la sua superficie è estremamente opaca (valore di riflessione speculare: 1,5 e 60°) e anti impronte digitali.

Grazie all'utilizzo della nanotecnologia, eventuali micrograffi possono essere riparati termicamente ed è inoltre piacevolmente soft touch.

FENIX NTM™ è Made in Italy.

FENIX NTM™ è un materiale innovativo di Arpa Industriale creato per l'interior design prodotto mediante

l'applicazione simultanea di calore (circa 150°C) e alta pressione specifica (> 7 MPa) per ottenere un prodotto omogeneo non poroso con densità elevata.

Il suo core è composto da carta impregnata in resina termoindurente mentre la superficie decorativa, ottenuta con l'ausilio di nanotecnologie, è costituita da una carta decorativa trattata con resine di nuova generazione frutto della ricerca di Arpa Industriale.

FENIX NTM™ è un materiale che si distingue per particolari caratteristiche quali: alta resistenza al graffio e al calore, anti impronta, morbidezza al tatto, bassa riflessione della luce, riparabilità termica dei micrograffi, alta attività di abbattimento della carica batterica.

FENIX NTM™ è un marchio registrato da Arpa Industriale.

FENIX NTM™ è placcato su truciolare idrorepellente e il top è bordato sui lati a vista con polipropilene spessore 1 mm in tinta.

# Technical information

## FENIX NTM™

It is a brand new interior design product developed by Arpa Industriale.

Using the most modern resins, this intelligent material stands out for the extraordinary characteristics of its surface.

The matt surface has an exceptionally low reflectivity (specular reflection index: 1.5 and 60°) and is highly resistant to hand and finger prints.

The material uses nanotechnology to enable micro-scratches to be healed thermally, and it also has a very pleasant soft touch effect.

FENIX NTM™ is Made in Italy.

FENIX NTM™ is an innovative interior design product from Arpa Industriale, made by applying heat (around 150°C) and high pressure (> 7 MPa) to obtain a non-porous very dense material.





















Its core is composed of paper impregnated with thermosetting resin, while the surface, which employs nanotechnology processes, is composed of a decorative paper treated with the most recently developed resins from the Arpa Industriale research labs.

FENIX NTM™ stands out for its exceptional resistance to scratching, heat and hand and finger prints, soft touch, low reflectivity, thermal healing of micro-scratches, and effective anti-bacterial action.

FENIX NTM™ is a registered trademark of Arpa Industriale.

FENIX NTM™ is fixed on waterproof fiberboard and the top is trimmed on visible sides with 1 mm polypropylene in matching colour.

## FENIX NTM™

	<b>Resistenza ai graffi e all'abrasione</b> Resistance to scratches and abrasion		<b>Stabilità dimensionale in presenza di elevata variazione termica</b> Dimensional stability even at high temperature changes
	<b>Alta attività di abbattimento della carica batterica</b> Enhanced anti-bacterial properties		<b>Resistenza all'urto</b> Resistance to impact
	<b>Igienico</b> Hygienic		<b>Stabilità alla luce</b> Lightfastness
	<b>Idoneo al contatto con gli alimenti</b> Suitable for contact with food		<b>Resistenza al calore secco</b> Resistance to dry heat
	<b>Facile da pulire</b> Easy to clean		<b>Eccellente intensità e profondità del colore</b> Excellent intensity and colour depth
	<b>Antimuffa</b> Mold-resistant		<b>Resistenza allo strofinamento</b> Rub resistance
	<b>Antistatico</b> Antistatic		<b>Elevata resistenza a solventi acidi e ai reagenti di uso domestico</b> High resistance to acid solvents and household reagents
	<b>Idrorepellente</b> Water proof		<b>Autoportante (solo per gli spessori 10 e 12 mm)</b> Self-supporting (only for 10 and 12 mm)
	<b>Bassa riflessione della luce, superficie estremamente opaca</b> Low light reflection, extremely matt surface		<b>Riparabilità termica dei micrograffi</b> Repairability thermal micro-scratches
	<b>Anti-impronta</b> Anti-huella digital		<b>Morbidezza al tatto</b> Soft to the touch

## FENIX NTM™

**RIPARABILITÀ TERMICA DEI MICROGRAFFI**  
Nanotech matt material for interior design



**ISTRUZIONI PER LA MANUTENZIONE:**  
MAINTENANCE

**FERRO DA STIRO:**  
CLOTHES IRON

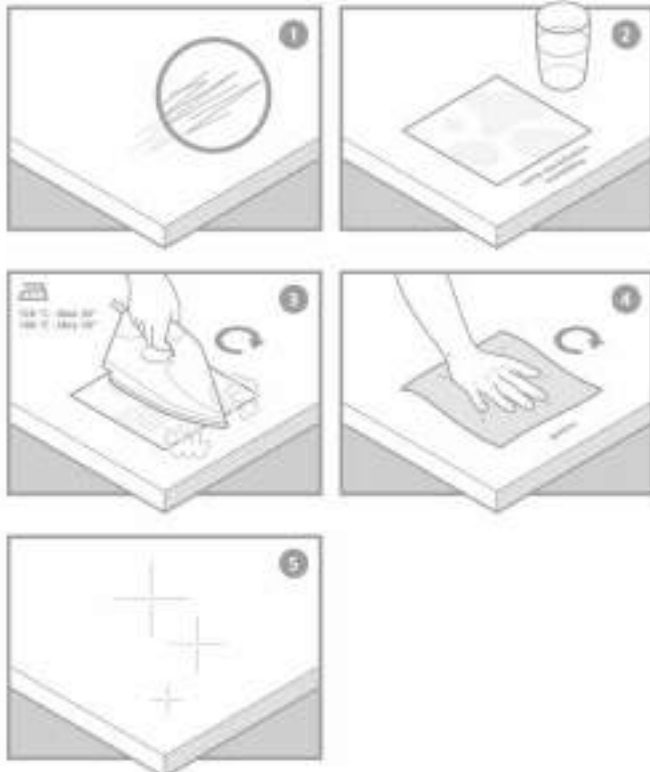

**ISTRUZIONI PER LA MANUTENZIONE:**  
MAINTENANCE

**SPUGNA DI SCHEUMA MELAMMINICA:**  
MELAMINE FOAM SPONGE

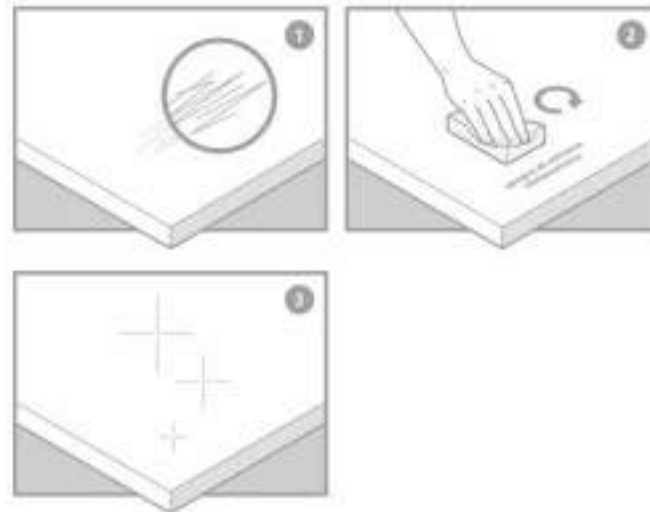

Visita [fenixntm.com](http://fenixntm.com)  
go to [fenixntm.com](http://fenixntm.com)

per scoprire tutte le proprietà  
for further details

made in Italy by Arpa Industriale

**SP. 22 MM**

# OLTRE **N**eck **L**UX

## CARATTERISTICHE TECNICHE

### ANTE E FRONTALI CASSETTI

anta sp.22 mm composta da un supporto in agglomerato di legno rivestito su due lati con pannelli in HDF classe E1, ricoperto in malta cementizia nei colori: old white (opz.MA11), old grey (opz.MA12), old dark (opz.MA13), old black (opz.MA14)

### VERSIONE **NECK**

anta squadrata, per gola ad "ELLE"

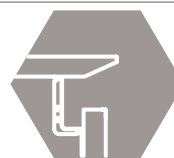

### VERSIONE **LUX** PROFILI E GOLE

di serie: anta profilo inclinata per gola ad "ELLE"  
a richiesta: anta profilo inclinata per gola piatta

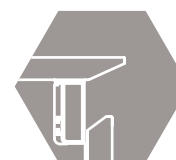
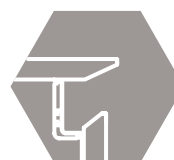

a richiesta: anta profilo alluminio inclinata per gola ad "ELLE"  
anta profilo alluminio inclinata per gola piatta

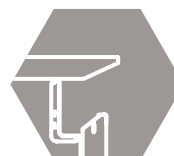

**N.B.:** maggiorazione per profilo vedi prezzi fascia F18

### STRUTTURE

#### ANTA: old white

di serie : nobilitato conchiglia (opz.8910) schiena e ripiano conchiglia (opz.8910)

#### ANTA: old grey, old black

di serie : nobilitato lavagna (opz.9620) schiena e ripiano lavagna (opz.9620)

#### ANTA: old dark

di serie : nobilitato fango (opz.8860) schiena e ripiano fango (opz.8860)

a richiesta : nobilitato perla d'oriente (opz.940) schiena e ripiano bianco (opz.001)  
nobilitato bianco (opz.001) schiena e ripiano bianco (opz.001)  
nobilitato visone (opz.948M) schiena e ripiano visone (opz.948M)  
nobilitato argilla (opz.9690) schiena e ripiano argilla (opz.9690)



### MENSOLE

di serie: altezza cm 3,8 in laminato come strutture: bianco (opz.001), perla d'oriente (opz.940), visone (opz.948M), lavagna (opz.9620), fango (opz.8860), argilla (opz.9690), conchiglia (opz.8910)

a richiesta: altezza cm 3,8 finiture come ante

### ZOCCOLI

vedi pag.49



TH. 22 MM

# OLTRE **N**eck **L**UX

## TECHNICAL FEATURES

### DOORS AND DRAWER FRONTS

22 mm th. door comprised of a support in wood composite covered on two sides with class E1 HDF panels, covered in cement mortar in the following colours: old white (opt.MA11), old grey (opt.MA12), old dark (opt.MA13), old black (opt.MA14)

### NECK VERSION

square edge door, for "L-SHAPED" finger rail

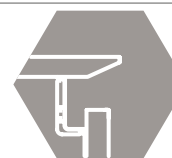

### PROFILES AND FINGER RAILS LUX VERSION

**standard:** inclined edge door, for "L-SHAPED" finger rail  
**on request:** inclined edge door, for flat finger rail

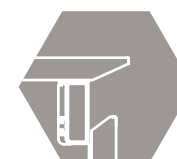
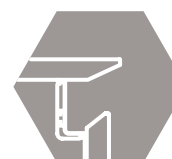

**on request:** aluminium inclined edge door, for "L-SHAPED" finger rail  
aluminium inclined edge door, for flat finger rail

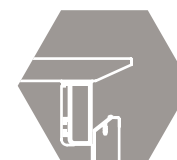
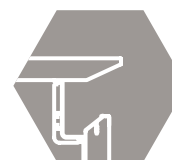

**N.B.:** surcharge for edge, see category F18 prices

### STRUCTURES

**DOOR: old white**  
**standard:** melamine-coated shell (opt.8910), shell back panel and shelf (opt.8910)  
**DOORS: old grey, old black**  
**standard:** melamine-coated slate grey (opt.9620), slate grey back panel and shelf (opt.9620)  
**DOOR: old dark**  
**standard:** melamine-coated mud (opt.8860), mud back panel and shelf (opt.8860)

**on request:** melamine-coated oriental pearl (opt.940), white back panel and shelf (opt.001)  
melamine-coated white (opt.001), white back panel and shelf (opt.001)  
melamine-coated mink (opt. 948M), mink back panel and shelf (opt.948M)  
melamine-coated clay (opt.9690), clay back panel and shelf (opt.9690)

### SHELVES

**standard:** : height 3.8 cm, in laminate to match structure: white (opt.001) oriental pearl (opt.940), mink (opt.948M), slate grey (opt.9620), mud (opt.8860), clay (opt.9690), shell (opt.8910)

**on request:** height 3.8 cm, finished to match doors

### PLINTHS

see page 49

**SP. 22 MM TH. 22 MM**

**OLTRE** Neck  
Lux

anta finitura malta  
door with mortar finish



old white (opz.MA11)



old grey (opz.MA12)



old dark (opz.MA13)



old black (opz.MA14)

**N**eck



particolare anta squadrata  
squared edge door detail

**L**UX



particolare anta inclinata  
inclined edge door detail



particolare anta inclinata  
con profilo alluminio  
vedi maggiorazione prezzi F18  
inclined edge door with  
aluminium profile detail  
see surcharge on "F18" band  
of the pricelist

## Informazioni tecniche

La malta cementizia è realizzata con impasti derivati da miscele, attentamente studiate, di leganti idraulici ed inerti, a base di farine di quarzo e sabbie minerali a granulometria controllata, esente da sali ed impurezze. A questo formulato viene aggiunta una percentuale (1÷2%) di polimeri elastomerici stabilizzanti, per evitare tensioni o crepe generate da sbalzi di temperatura e sollecitazioni dinamiche particolari. Prima dell'applicazione le superfici vengono trattate per poter permettere l'applicazione del rasante. Quest'ultimo viene applicato rigorosamente a mano da esperti artigiani su pannelli compositi. Sulla superficie, una volta asciutta, vengono applicate più mani di rivestimento acrilico trasparente: questo trattamento protegge la superficie da infiltrazioni di unto e sporco.

La particolarità del prodotto e soprattutto il modo di applicazione, ne determinano un aspetto cementizio con alcune caratteristiche proprie della sua natura, quali piccole imperfezioni, piccoli fori ed angoli non perfettamente squadrate e segni disomogenei della spatola, che esaltano la lavorazione artigianale.

## Uso e manutenzione

La collezione è caratterizzata da un'adeguata resistenza alle abrasioni, ai graffi e alle possibili macchie. È comunque molto importante un corretto trattamento e una corretta manutenzione del prodotto.

Per quanto concerne la pulizia delle superfici è indicato l'uso di detersivi neutri diluiti in acqua tiepida (proporzione 1:10, ad esempio 0,1 L di prodotto pulente e 1 L di acqua) e passati con dei semplici panni in microfibra. È consigliato risciacquare i detersivi usati, in quanto si riduce notevolmente il rischio di usura dello strato di rivestimento a protezione della superficie. È altamente sconsigliato l'utilizzo di prodotti concentrati e di sistemi di pulizia a vapore.

## Technical Information

Cement mortar is made from pastes derived from carefully blended mixtures of inert hydraulic bonding agents, comprised of quartz and mineral sands with controlled granule sizes free from salts and impurities. This formula is then blended with a percentage (1-2%) of stabilising elastomeric polymers to prevent tensions and cracks caused by temperature changes and dynamic stresses. The surfaces are treated before application to allow the coating to adhere. The coating is then applied by hand by expert craftsmen onto the composite panels. Once dry, the surface is then treated with a transparent acrylic coating: this treatment protects the surface against grease and dirt.

The special qualities of the product, and in particular the application method, create a cement effect that has certain inherent properties, such as small imperfections, tiny holes, and corners that aren't perfectly square. There may also be uneven trowel marks, all of which highlight the craft manufacture.

## Use and maintenance

This collection is characterised by good resistance to abrasion, scratches and stains.

It is nonetheless very important to treat and maintain the product correctly.

With regards to cleaning surfaces, we recommend the use of neutral detergents diluted in tepid water (dilution 1:10, e.g. 0.1 L of cleaning product in 1 L of water) applied using a micro-fibre cloth.

We recommend rinsing off any detergents used as this considerably reduces the wear on the coating protecting the surface. The use of concentrated cleaning products and steam cleaning systems should be strictly avoided.

sezione anta  
door section

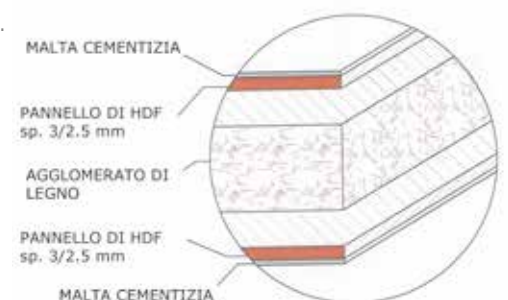





SP. 22 MM

OLTRE **N**eck  
**L**UX

## CARATTERISTICHE TECNICHE

ANTE E FRONTALI  
CASSETTI

anta sp.22 mm in mdf laccata **finitura opaca testurizzata soft nei colori**

 [CLICCA QUI PER LA GAMMA COLORI DISPONIBILI](#)

 [CLICK HERE FOR THE RANGE OF AVAILABLE COLORS](#)

VERSIONE **NECK**

anta squadrata, per gola ad "ELLE"

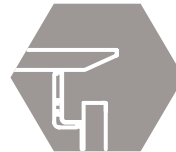

VERSIONE **LUX**  
PROFILI E GOLE

**di serie:** anta profilo inclinata per gola ad "ELLE"  
**a richiesta:** anta profilo inclinata per gola piatta

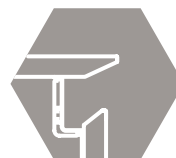

**a richiesta:** anta profilo alluminio inclinata per gola ad "ELLE"  
anta profilo alluminio inclinata per gola piatta

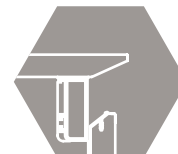

STRUTTURE

**di serie:** nobilitato bianco (opz.001) schiena e ripiano bianco (opz.001)

**a richiesta:** nobilitato visone (opz.948M) schiena e ripiano visone (opz.948M)  
nobilitato lavagna (opz.9620) schiena e ripiano lavagna (opz.9620)  
nobilitato perla d'oriente (opz.940) schiena e ripiano bianco (opz.001)  
nobilitato fango (opz.8860) schiena e ripiano fango (opz.8860)  
nobilitato conchiglia (opz.8910) schiena e ripiano conchiglia (opz.8910)  
nobilitato argilla (opz.9690) schiena e ripiano argilla (opz.9690)



MENSOLE

**di serie:** altezza cm 3,8 in laminato come strutture: bianco (opz.001), perla d'oriente (opz.940), visone (opz.948M), lavagna (opz.9620), fango (opz.8860), argilla (opz.9690), conchiglia (opz.8910)

**a richiesta:** altezza cm 3,8 laccate opache finiture come ante

ZOCCOLI

[vedi pag.49](#)



SP. 22 MM

OLTRE **N**eck  
**L**UX

## CARATTERISTICHE TECNICHE

### ANTE E FRONTALI CASSETTI

anta sp.22 mm in mdf laccata **finitura lucida spazzolata nei colori**

 [CLICCA QUI PER LA GAMMA COLORI DISPONIBILI](#)

 [CLICK HERE FOR THE RANGE OF AVAILABLE COLORS](#)

### VERSIONE **NECK**

anta squadrata, per gola ad "ELLE"



### VERSIONE **LUX** PROFILI E GOLE

**di serie:** anta profilo inclinata per gola ad "ELLE"  
**a richiesta:** anta profilo inclinata per gola piatta

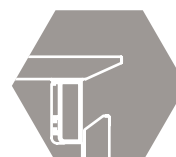

**a richiesta:** anta profilo alluminio inclinata per gola ad "ELLE"  
anta profilo alluminio inclinata per gola piatta

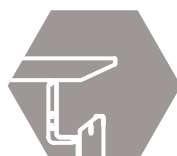

### STRUTTURE

**di serie:** nobilitato bianco (opz.001) schiena e ripiano bianco (opz.001)

**a richiesta:** nobilitato visone (opz.948M) schiena e ripiano visone (opz.948M)  
nobilitato lavagna (opz.9620) schiena e ripiano lavagna (opz.9620)  
nobilitato perla d'oriente (opz.940) schiena e ripiano bianco (opz.001)  
nobilitato fango (opz.8860) schiena e ripiano fango (opz.8860)  
nobilitato conchiglia (opz.8910) schiena e ripiano conchiglia (opz.8910)  
nobilitato argilla (opz.9690) schiena e ripiano argilla (opz.9690)



### MENSOLE

**di serie:** altezza cm 3,8 in laminato come strutture: bianco (opz.001), perla d'oriente (opz.940), visone (opz.948M), lavagna (opz.9620), fango (opz.8860), argilla (opz.9690), conchiglia (opz.8910)

**a richiesta:** altezza cm 3,8 laccate lucide finiture come ante

### ZOCCOLI

[vedi pag.49](#)



cod.

**G53**Neck **G63**Lux

Matt Lacquered

TH. 22 MM

OLTRE **N**eck  
**L**ux

## TECHNICAL FEATURES

### DOORS AND DRAWER FRONTS

22 mm th. MDF door, with **soft textured matt lacquered finish in the following colours:**

 [CLICCA QUI PER LA GAMMA COLORI DISPONIBILI](#)

 [CLICK HERE FOR THE RANGE OF AVAILABLE COLORS](#)

### NECK VERSION

square edge door, for "L-SHAPED" finger rail

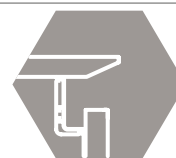

### PROFILES AND FINGER RAILS LUX VERSION

**standard:** inclined edge door, for "L-SHAPED" finger rail  
**on request:** inclined edge door, for flat finger rail

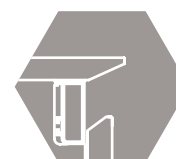
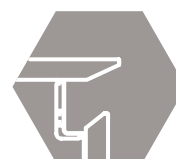

**on request:** aluminium inclined edge door, for "L-SHAPED" finger rail  
aluminium inclined edge door, for flat finger rail

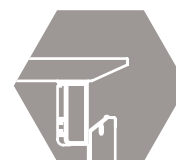
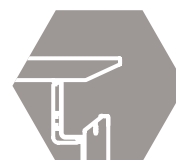

### STRUCTURES

**standard:** melamine-coated white (opt.001), white back panel and shelf (opt.001)

**on request:** melamine-coated mink (opt.948M), mink back panel and shelf (opt.948M)  
melamine-coated slate grey (opt.9620), slate grey back panel and shelf (opt.9620)  
melamine-coated oriental pearl (opt.940), white back panel and shelf (opt.001)  
melamine-coated mud (opt.8860), mud back panel and shelf (opt.8860)  
melamine-coated shell (opt.8910), shell back panel and shelf (opt.8910)  
melamine-coated clay (opt.9690), clay back panel and shelf (opt.9690)

### SHELVES

**standard:** : height 3.8 cm, in laminate to match structure: white (opt.001) oriental pearl (opt.940), mink (opt.948M), slate grey (opt.9620), mud (opt.8860), clay (opt.9690), shell (opt.8910)

**on request:** height 3.8 cm, matt lacquered finish to match doors

### PLINTHS

[see page 49](#)

TH. 22 MM

# OLTRE

Neck  
LUX

## TECHNICAL FEATURES

### DOORS AND DRAWER FRONTS

22 mm th. MDF door, with **brushed glossy lacquered finish in the following colours:**

[CLICCA QUI PER LA GAMMA COLORI DISPONIBILI](#)

[CLICK HERE FOR THE RANGE OF AVAILABLE COLORS](#)

### NECK VERSION

square edge door, for "L-SHAPED" finger rail

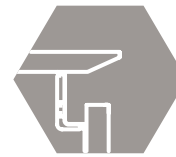

### PROFILES AND FINGER RAILS LUX VERSION

**standard:** inclined edge door, for "L-SHAPED" finger rail  
**on request:** inclined edge door, for flat finger rail

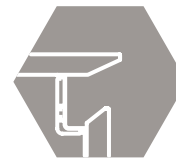

**on request:** aluminium inclined edge door, for "L-SHAPED" finger rail  
aluminium inclined edge door, for flat finger rail

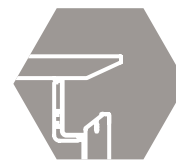

### STRUCTURES

**standard:** melamine-coated white (opt.001), white back panel and shelf (opt.001)

**on request:** melamine-coated mink (opt.948M), mink back panel and shelf (opt.948M)  
melamine-coated slate grey (opt.9620), slate grey back panel and shelf (opt.9620)  
melamine-coated oriental pearl (opt.940), white back panel and shelf (opt.001)  
melamine-coated mud (opt.8860), mud back panel and shelf (opt.8860)  
melamine-coated shell (opt.8910), shell back panel and shelf (opt.8910)  
melamine-coated clay (opt.9690), clay back panel and shelf (opt.9690)

### SHELVES

**standard:** : height 3.8 cm, in laminate to match structure: white (opt.001) oriental pearl (opt.940), mink (opt.948M), slate grey (opt.9620), mud (opt.8860), clay (opt.9690), shell (opt.8910)

**on request:** height 3.8 cm, glossy lacquered finish to match doors

### PLINTHS

[see page 49](#)

cod. **G53**<sub>Neck</sub> **G63**<sub>Lux</sub>

Laccato Opaco  
Matt Lacquered

**SP. 22 MM TH. 22 MM**

ante laccate opache matt doors lacquered

**OLTRE** **N**eck  
**L**UX



**N**eck

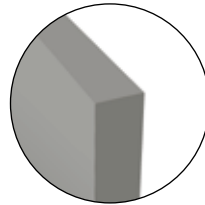

particolare anta squadrata  
squared edge door detail

**L**UX

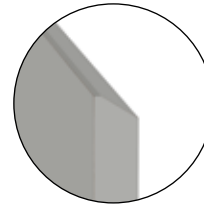

particolare anta inclinata  
inclined edge door detail



particolare anta inclinata  
con profilo alluminio  
inclined edge door with  
aluminium profile detail

cod. **G54**<sub>Neck</sub> **G64**<sub>Lux</sub>

Laccato Lucido Spazzolato  
Brushed Glossy Lacquered

**SP. 22 MM** TH. 22 MM

ante laccate lucide glossy doors lacquered



cassetto grigio bromo (opz.9534)  
bromine grey drawer (opt.9534)



# OLTRE **N**eck **L**UX

**N**eck

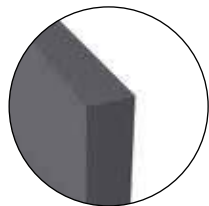

particolare anta squadrata  
squared edge door detail

**L**UX

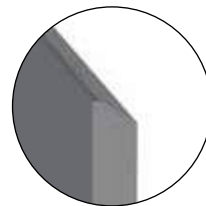

particolare anta inclinata  
inclined edge door detail

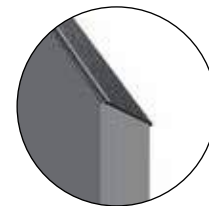

particolare anta inclinata  
con profilo alluminio  
inclined edge door with  
aluminium profile detail

SP. 22 MM

OLTRE **N**eck  
**L**UX

## CARATTERISTICHE TECNICHE

### ANTE E FRONTALI CASSETTI

anta sp.22 mm in mdf laccata **finitura semilucida effetto metallo vintage** nei colori:  
peltro (opz.9549), ferro (opz.9506), bronzo (opz.8904)

anta sp.22 mm in mdf laccata **finitura semilucida effetto metallo vintage spazzolato** nei colori:  
bronzo anticato (opz.8909), rame anticato (opz.8159), nichel (opz.9505), bronzo brunito (opz.8903), grafite (opz.9508), urban (opz.7894)

### VERSIONE **NECK**

anta squadrata, per gola ad "ELLE"

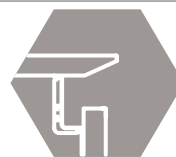

### VERSIONE **LUX** PROFILI E GOLE

**di serie:** anta profilo inclinata per gola ad "ELLE"  
**a richiesta:** anta profilo inclinata per gola piatta

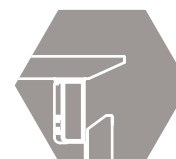
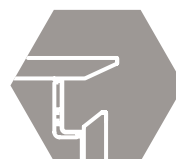

**a richiesta:** anta profilo alluminio inclinata per gola ad "ELLE"  
anta profilo alluminio inclinata per gola piatta

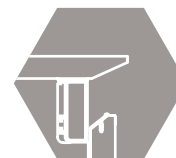
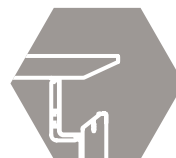

### STRUTTURE

**ANTE: peltro, ferro, urban, grafite**

**di serie:** nobilitato lavagna (opz.9620) schiena e ripiano lavagna (opz.9620)

**ANTE: bronzo, rame anticato, bronzo brunito, bronzo anticato**

**di serie:** nobilitato fango (opz.8860) schiena e ripiano fango (opz.8860)

**ANTA: nichel**

**di serie:** nobilitato visone (opz.948M) schiena e ripiano visone (opz.948M)

**a richiesta:** nobilitato bianco (opz.001) schiena e ripiano bianco (opz.001)  
nobilitato perla d'oriente (opz.940) schiena e ripiano bianco (opz.001)  
nobilitato conchiglia (opz.8910) schiena e ripiano conchiglia (opz.8910)  
nobilitato argilla (opz.9690) schiena e ripiano argilla (opz.9690)



### MENSOLE

**di serie:** altezza cm 3,8 in laminato come strutture: bianco (opz.001), perla d'oriente (opz.940), visone (opz.948M), lavagna (opz.9620), fango (opz.8860), argilla (opz.9690), conchiglia (opz.8910)

**a richiesta:** altezza cm 3,8 finiture come ante

### ZOCCOLI

**vedi pag.49**





TH. 22 MM

# OLTRE **N**eck **L**UX

## TECHNICAL FEATURES

### DOORS AND DRAWER FRONTS

22 mm th. door in mdf with **vintage metal effect semi-gloss lacquer finish** in the following colours: pewter (opt. 9549), iron (opt. 9506), bronze (opt. 8904)

22 mm th. door in mdf with **vintage metal effect semi-gloss lacquer brushed finish** in the following colours: antique bronze (opt. 8909), antique copper (opt. 8159), nickel (opt. 9505), burnished bronze (opt. 8903), graphite (opt. 9508), urban (opt. 7894)

### NECK VERSION

square edge door, for "L-SHAPED" finger rail

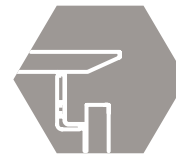

### PROFILES AND FINGER RAILS **LUX** VERSION

**standard:** inclined edge door, for "L-SHAPED" finger rail  
**on request:** inclined edge door, for flat finger rail

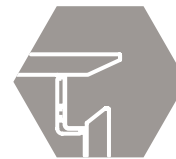

**on request:** aluminium inclined edge door, for "L-SHAPED" finger rail  
aluminium inclined edge door, for flat finger rail

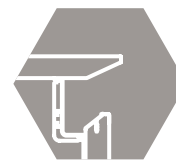

### STRUCTURES

**DOORS:** pewter, iron, urban, graphite

**standard:** melamine-coated slate grey (opt.9620), slate grey back panel and shelf (opt.9620)

**DOORS:** bronze, antique copper, burnished bronze, antique bronze

**standard:** melamine-coated mud (opt.8860), mud back back panel and shelf (opt.8860)

**DOOR:** nickel

**standard:** melamine-coated mink (opt.948M), mink back panel and shelf (opt.948M)

**on request:** melamine-coated white (opt.001), white back panel and shelf (opt.001)

melamine-coated oriental pearl (opt.940), white back panel and shelf (opt.001)

melamine-coated shell (opt.8910), shell back panel and shelf (opt.8910)

melamine-coated clay (opt.9690), clay back panel and shelf (opt.9690)

### SHELVES

**standard:** : height 3.8 cm, in laminate to match structure: white (opt. 001) oriental pearl (opt. 940), mink (opt. 948M), slate grey (opt. 9620), mud (opt. 8860), clay (opt.9690), shell (opt.8910)

**on request:** height 3.8 cm, finished to match doors

### PLINTHS

see page 49

SP. 22 MM TH. 22 MM

ante laccate vintage effetto metallo  
lacquered vintage doors metal effect

OLTRE **N**eck  
**L**UX



peltro (opz.9549)  
pewter (opt.9549)



ferro (opz.9506)  
iron opt.9506)



bronzo (opz.8904)  
bronze (opt.8904)

ante laccate vintage effetto spazzolato  
lacquered vintage doors brushed effect



bronzo brunito (opz.8903)  
burnished bronze (opt.8903)



grafite (opz.9508)  
graphite (opt.9508)



nichel (opz.9505)  
nickel (opt.9505)



bronzo anticato (opz.8909)  
antique bronze (opt.8909)



rame anticato (opz.8159)  
antique copper (opt.8159)



urban (opz.7894)  
urban (opt.7894)

**N**eck

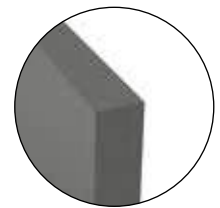

particolare anta squadrata  
squared edge door detail

**L**UX

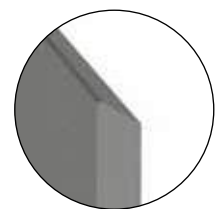

particolare anta inclinata  
inclined edge door detail



particolare anta inclinata  
con profilo alluminio  
inclined edge door with  
aluminium profile detail

# OLTRE Neck Telaio alluminio

Aluminium frame

Vetro  
Glass

**abbinabile alle versioni: G50-G51-G52-G53-G54**

matched with versions: G50-G51-G52-G53-G54

**di serie:** telaio alluminio sp.22 mm verniciato a polvere nero,  
vetro temperato bronzo o fumè trasparente sp.4 mm

**standard:** 22mm th. aluminium frame with black powder coating,  
4mm th. tempered bronze or smoked transparent glass

**NEW**



vetro bronzo (opz.NBZ)  
bronze glass (opt.NBRZ)

**NEW**



vetro fumè (opz.NFUM)  
smoked glass (opt.NFUM)



particolare telaio svasatura esterna  
detail frame with external flared

Neck



particolare anta squadrata  
squared edge door detail

SP. 22 MM TH. 22 MM

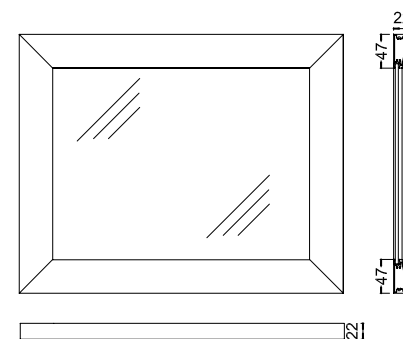

**a richiesta:** telaio alluminio sp.22 mm finitura urban ossidato  
vetro temperato bronzo o fumè trasparente sp.4 mm

on request: 22 mm th. aluminium frame with urban oxidized finish,  
4mm th. tempered bronze or smoked transparent glass

**NEW**



vetro bronzo (opz.NUBZ)  
bronze glass (opt.NUBZ)

**NEW**



vetro fumè (opz.NUFM)  
smoked glass (opt.NUFM)

Neck

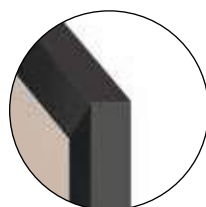

particolare anta squadrata  
squared edge door detail

SP. 22 MM TH. 22 MM

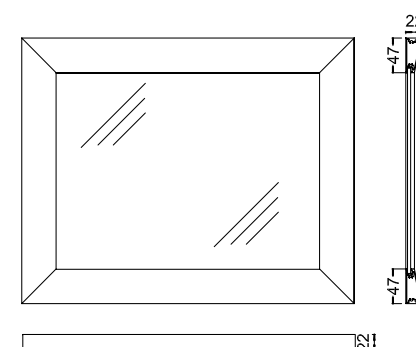

TELAIO  
ALLUMINIO  
ALUMINIUM FRAME

**abbinabile alle versioni: G50-G51-G52-G53-G54**

matched with versions: G50-G51-G52-G53-G54

**di serie:** telaio alluminio sp.22 mm verniciato a polvere nero,  
vetro temperato master line sp.4 mm (opz.NML)

**standard:** 22mm th. aluminium frame with black powder coating, 4mm th. master line tempered glass (opt.NML)



particolare telaio svasatura esterna  
detail frame with external flared

**N**eck



particolare anta squadrata  
squared edge door detail

**SP. 22 MM TH. 22 MM**

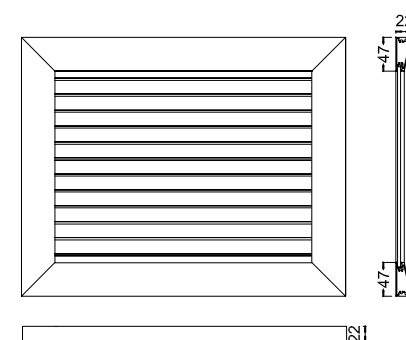

a richiesta: telaio alluminio sp.22 mm finitura urban ossidato

vetro bronzo temperato serigrafato in glitter decoro retinato sp.4 mm (opz.NUBR)

on request: 22 mm th. aluminium frame with urban oxidized finish, 4mm th. screen-printed tempered bronze glass with glitter mesh decor (opt.NUBR)



**N**eck



particolare anta squadrata  
squared edge door detail

**SP. 22 MM TH. 22 MM**

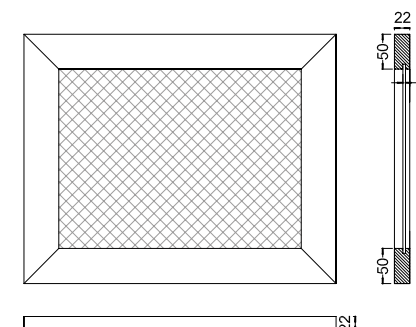

**abbinabile alle versioni: G50-G51-G52-G53-G54**

matched with versions: G50-G51-G52-G53-G54

a richiesta: telaio alluminio sp.22 mm finitura urban ossidato con pannello in lamiera stirata in alluminio effetto rete anodizzata nera (opz.NUR)

on request: 22 mm th. aluminium frame with urban oxidized finish and aluminium stretched metal sheet panel with black anodised mesh effect (opt.NUR)



**Neck**

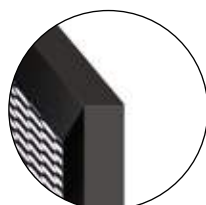

particolare anta squadrata  
squared edge door detail

**SP. 22 MM TH. 22 MM**

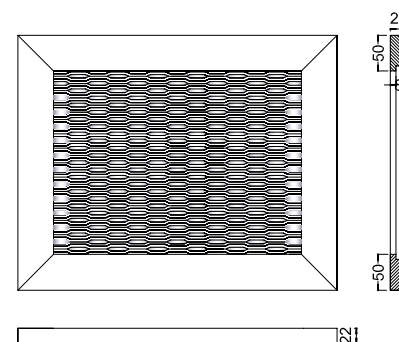

a richiesta: telaio alluminio sp.22 mm finitura urban ossidato con pannello in mdf idro placcato 2 lati in laminato lavagna nero (opz.NUL)

on request: 22 mm th. aluminium frame with urban oxidized finish, with idro mdf plated with blackboard laminate on both sides (opt.NUL)



**Neck**



particolare anta squadrata  
squared edge door detail

**SP. 22 MM TH. 22 MM**

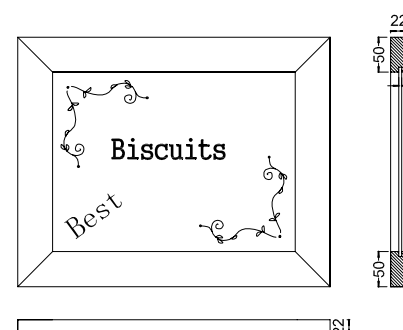

SP. 22 MM

# OLTRE

**N**eck  
**L**ux

## CARATTERISTICHE TECNICHE

### ANTE E FRONTALI CASSETTI

telaio alluminio sp.22 mm verniciato a polvere finitura opaca in tinta con il vetro, tamburato nella parte posteriore con pannello in HDF grigio cenere sp.3 mm.

Vetro temperato satinato sp.4 mm laccato nei colori **freddi**:  
bianco assoluto (opz.V740S), cenere (opz.V9547), grigio bromo (opz.V9533), nero (opz.V7892)

Vetro temperato satinato sp.4 mm laccato nei colori **caldi**:  
bianco caldo (opz.V7401), canapa (opz.V8531), castoro (opz.V8907), fumo (opz.V9531), verde lichene (opz.V8463), bistro (opz.V9535), rosso toscano (opz.V8157), giallo ambra (opz.V327S), grigio piombo (opz.V9537), verde positano (opz.V8471), bronzo (opz.V8903)

### VERSIONE **NECK**

anta squadrata, per gola ad "ELLE"

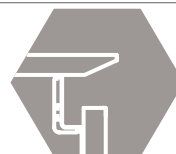

### VERSIONE **LUX** PROFILI E GOLE

**di serie:** anta profilo inclinata per gola ad "ELLE"  
**a richiesta:** anta profilo inclinata per gola piatta

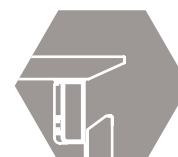

### STRUTTURE

**di serie:** nobilitato bianco (opz.001) schiena e ripiano bianco (opz.001)

**a richiesta:** nobilitato visone (opz.948M) schiena e ripiano visone (opz.948M)  
nobilitato lavagna (opz.9620) schiena e ripiano lavagna (opz.9620)  
nobilitato perla d'oriente (opz.940) schiena e ripiano bianco (opz.001)  
nobilitato fango (opz.8860) schiena e ripiano fango (opz.8860)  
nobilitato conchiglia (opz.8910) schiena e ripiano conchiglia (opz.8910)  
nobilitato argilla (opz.9690) schiena e ripiano argilla (opz.9690)



### MENSOLE

**di serie:** altezza cm 3,8 in laminato come strutture: bianco (opz.001), perla d'oriente (opz.940), visone (opz.948M), lavagna (opz.9620), fango (opz.8860), argilla (opz.9690), conchiglia (opz.8910)

**a richiesta:** altezza cm 3,8 laccate opache finitura come ante laccate

### ZOCCOLI

vedi pag.49



SP. 22 MM

# OLTRE **N**eck **L**UX

## CARATTERISTICHE TECNICHE

### ANTE E FRONTALI CASSETTI

telaio alluminio sp.22 mm verniciato a polvere finitura opaca in tinta con il vetro, tamburato nella parte posteriore con pannello in HDF grigio cenere sp.3 mm.

Vetro temperato lucido sp.4 mm laccato nei colori **freddi**: bianco assoluto (opz.V741), cenere (opz.V9548), grigio bromo (opz.V9534), nero (opz.V7893)

Vetro temperato lucido sp.4 mm laccato nei colori **caldi**: bianco caldo (opz.V7402), canapa (opz.V8532), castoro (opz.V8908), fumo (opz.V9532), verde lichene (opz.V8464), bistro (opz.V9536), rosso toscano (opz.V8158), giallo ambra (opz.V328), grigio piombo (opz.V9538), verde positano (opz.V8472), bronzo (opz.V8904)

### VERSIONE **NECK**

anta squadrata, per gola ad "ELLE"

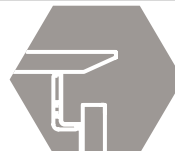

### VERSIONE **LUX** PROFILI E GOLE

**di serie:** anta profilo inclinata per gola ad "ELLE"  
**a richiesta:** anta profilo inclinata per gola piatta



### STRUTTURE

**di serie:** nobilitato bianco (opz.001) schiena e ripiano bianco (opz.001)

**a richiesta:** nobilitato visone (opz.948M) schiena e ripiano visone (opz.948M)  
nobilitato lavagna (opz.9620) schiena e ripiano lavagna (opz.9620)  
nobilitato perla d'oriente (opz.940) schiena e ripiano bianco (opz.001)  
nobilitato fango (opz.8860) schiena e ripiano fango (opz.8860)  
nobilitato conchiglia (opz.8910) schiena e ripiano conchiglia (opz.8910)  
nobilitato argilla (opz.9690) schiena e ripiano argilla (opz.9690)



### MENSOLE

**di serie:** altezza cm 3,8 in laminato come strutture: bianco (opz.001), perla d'oriente (opz.940), visone (opz.948M), lavagna (opz.9620), fango (opz.8860), argilla (opz.9690), conchiglia (opz.8910)

**a richiesta:** altezza cm 3,8 laccate lucide finitura come ante laccate

### ZOCCOLI

vedi pag.49



TH. 22 MM

**OLTRE** Neck  
LUX

**TECHNICAL FEATURES**

**DOORS AND DRAWER FRONTS**

Aluminium frame Th.22 mm dust painted with matt finish matching with the glass and back coated with an HDF panel colour ash grey

Hardened satin glass, lacquered in the following **cold** colours:  
absolute white (opt.V740S), ash (opt.V9547), bromine grey (opt.V9533), black (opt.V7892)

Hardened satin glass, lacquered in the following **hot** colours:  
warm white (opt.V7401), hemp (opt.V8531), beaver (opt.V8907), smoke (opt.V9531), lichen green (opt.V8463), bistro (opt.V9535), tuscan red (opt.V8157), amber yellow (opt.V327S), lead grey (opt.V9537), positano green (opt.V8471), bronze (opt.V8903)

**NECK VERSION**

square edge door, for "L-SHAPED" finger rail

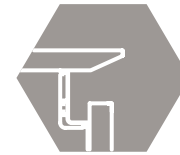

**PROFILES AND FINGER RAILS LUX VERSION** **standard:** inclined edge door, for "L-SHAPED" finger rail  
**on request:** inclined edge door, for flat finger rail

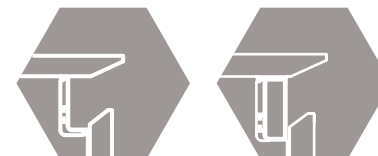

**STRUCTURES**

**standard:** melamine-coated white (opt.001), white back panel and shelf (opt.001)

**on request:** melamine-coated mink (opt.948M), mink back panel and shelf (opt.948M)  
melamine-coated slate grey (opt.9620), slate grey back panel and shelf (opt.9620)  
melamine-coated oriental pearl (opt.940), white back panel and shelf (opt.001)  
melamine-coated mud (opt.8860), mud back panel and shelf (opt.8860)  
melamine-coated shell (opt.8910), shell back panel and shelf (opt.8910)  
melamine-coated clay (opt.9690), clay back panel and shelf (opt.9690)

**SHELVES**

**standard:** : height 3.8 cm, in laminate to match structure: white (opt.001) oriental pearl (opt.940), mink (opt.948M), slate grey (opt.9620), mud (opt.8860), clay (opt.9690), shell (opt.8910)

**on request:** height 3.8 cm, matt lacquered same finish as laquered doors

**PLINTHS**

see page 49



TH. 22 MM

**OLTRE** **N**eck  
**L**UX

**TECHNICAL FEATURES**

**DOORS AND  
DRAWER FRONTS**

aluminium frame Th.22 mm dust painted with matt finish matching with the glass and back coated with an HDF panel colour ash grey

Hardened glossy glass, lacquered in the following **cold** colours:  
absolute white (opt.V741), ash (opt.V9548), bromine grey (opt.V9534), black (opt.V7893)

Hardened glossy glass, lacquered in the following **hot** colours:  
warm white (opt.V7402), hemp (opt.V8532), beaver (opt.V8908), smoke (opt.V9532), lichen green (opt.V8464), bistro (opt.V9536), tuscan red (opt.V8158), amber yellow (opt.V328), lead grey (opt.V9538), positano green (opt.V8472), bronze (opt.V8904)

**NECK VERSION**

square edge door, for "L-SHAPED" finger rail

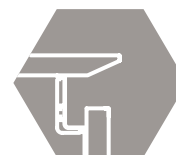

**PROFILES AND FINGER  
RAILS LUX VERSION**

**standard:** inclined edge door, for "L-SHAPED" finger rail  
**on request:** inclined edge door, for flat finger rail

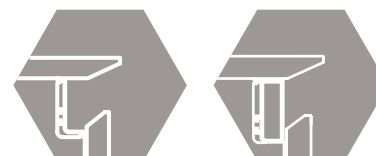

**STRUCTURES**

**standard:** melamine-coated white (opt.001), white back panel and shelf (opt.001)

**on request:** melamine-coated mink (opt.948M), mink back panel and shelf (opt.948M)  
melamine-coated slate grey (opt.9620), slate grey back panel and shelf (opt.9620)  
melamine-coated oriental pearl (opt.940), white back panel and shelf (opt.001)  
melamine-coated mud (opt.8860), mud back panel and shelf (opt.8860)  
melamine-coated shell (opt.8910), shell back panel and shelf (opt.8910)  
melamine-coated clay (opt.9690), clay back panel and shelf (opt.9690)

**SHELVES**

**standard:** : height 3.8 cm, in laminate to match structure: white (opt.001) oriental pearl (opt.940), mink (opt.948M), slate grey (opt.9620), mud (opt.8860), clay (opt.9690), shell (opt.8910)

**on request:** height 3.8 cm, glossy lacquered same finish as laquered doors

**PLINTHS**

see page 49

cod. **G55** Neck **G65** Lux

Vetro Satinato  
Satin Glass

OLTRE **N**eck  
**L**UX

SP. 22 MM TH. 22 MM

anta vetro satinato  
satin glass door



telaio alluminio, vetro fumo (opz.V9531)  
aluminum frame, smoke glass (opt.V9531)



particolare retro anta grigio cenere  
detail of the back side of the door,  
ash grey colour

**N**eck

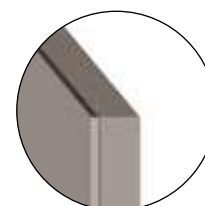

particolare anta squadrata  
squared edge door detail

**COLORI FREDDI SATINATI SATIN COLD COLOURS**



bianco assoluto  
satinato (opz.V740S)  
satin absolute white

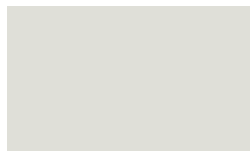

cenere satinato  
(opz.V9547)  
satin ash



grigio bromo satinato  
(opz.V9533)  
satin bromine grey

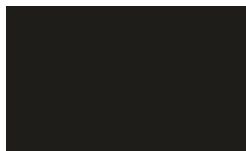

nero satinato  
(opz.V7892)  
satin black

**L**UX

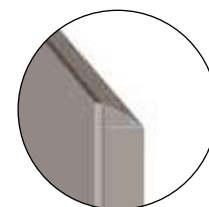

particolare anta inclinata  
inclined edge door detail

**COLORI CALDI SATINATI SATIN HOT COLOURS**

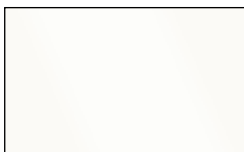

bianco caldo satinato  
(opz.V7401)  
satin warm white



canapa satinato  
(opz.V8531)  
satin hemp



castoro satinato  
(opz.V8907)  
satin beaver



fumo satinato  
(opz.V9531)  
satin smoke



verde lichene satinato  
(opz.V8463)  
satin lichen green



bistro satinato  
(opz.V9535)  
satin bistro



rosso toscano satinato  
(opz.V8157)  
satin tuscan red



giallo ambra satinato  
(opz.V327S)  
satin amber yellow



grigio piombo satinato  
(opz.V9537)  
satin lead grey



verde positano satinato  
(opz.V8471)  
satin positano green



bronzo satinato  
(opz.V8903)  
satin bronze

SP. 22 MM TH. 22 MM

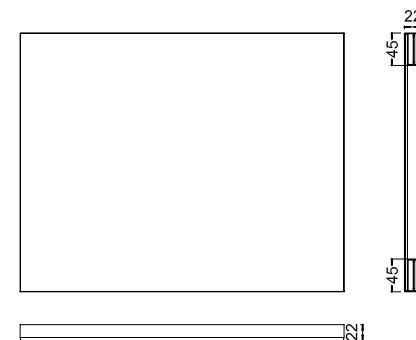

cod. **G56** Neck **G66** Lux

Vetro Lucido  
Glossy Glass

OLTRE **N**eck  
**L**ux

SP. 22 MM TH. 22 MM

anta vetro lucido  
glossy glass doors



telaio alluminio, vetro fumo (opz.V9532)  
aluminum frame, smoke glass (opt.V9532)



particolare retro anta grigio cenere  
detail of the back side of the door,  
ash grey colour

**N**eck

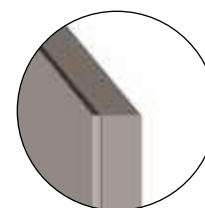

particolare anta squadrata  
squared edge door detail

**L**ux

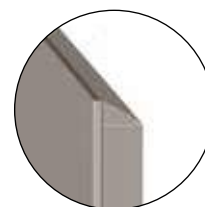

particolare anta inclinata  
inclined edge door detail

**COLORI FREDDI LUCIDO GLOSSY COLD COLOURS**



bianco assoluto lucido (opz.V741) glossy absolute white  
cenere lucido (opz.V9548) glossy ash  
grigio bromo lucido (opz.V9534) glossy bromine grey  
nero lucido (opz.V7893) glossy black

**COLORI CALDI LUCIDO GLOSSY HOT COLOURS**



bianco caldo lucido (opz.V7402) glossy warm white  
canapa lucido (opz.V8532) glossy hemp  
castoro lucido (opz.V8908) glossy beaver  
fumo lucido (opz.V9532) glossy smoke

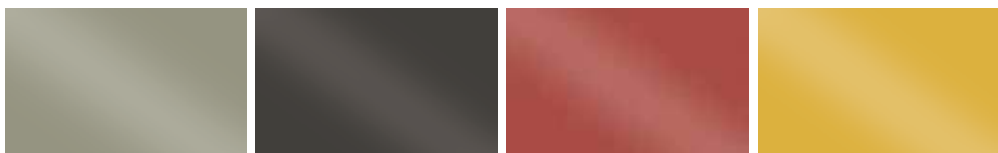

verde lichene lucido (opz.V8464) glossy lichen green  
bistro lucido (opz.V9536) glossy bistro  
rosso toscano lucido (opz.V8158) glossy tuscan red  
giallo ambra lucido (opz.V328) glossy amber yellow



grigio piombo lucido (opz.V9538) glossy lead grey  
verde positano lucido (opz.V8472) glossy positano green  
bronzio lucido (opz.V8904) glossy bronze

SP. 22 MM TH. 22 MM

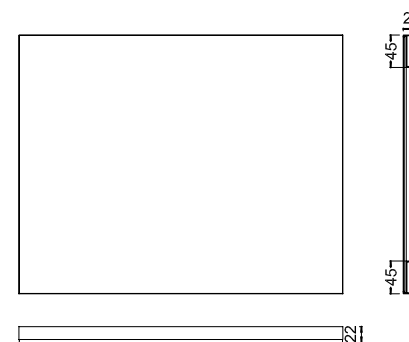

## strutture carcasses

**NEW**

**NEW**



bianco (opz.001)  
schiena e ripiano bianco  
(opz.001)  
white (opt.001)  
white back panel and shelf  
(opt.001)



perla d'oriente (opz.940)  
schiena e ripiano bianco  
(opz.001)  
oriental pearl (opt.940)  
white back panel and shelf  
(opt.001)



conchiglia (opz.8910)  
schiena e ripiano conchiglia  
(opz.8910)  
shell (opt.8910)  
shell back panel and shelf  
(opt.8910)



argilla (opz.9690)  
schiena e ripiano argilla  
(opz.9690)  
clay (opt.9690)  
clay back panel and shelf  
(opt.9690)



lavagna (opz.9620)  
schiena e ripiano lavagna  
(opz.9620)  
slate grey (opt.9620)  
slate grey back panel  
and shelf (opt.9620)



fango (opz.8860)  
schiena e ripiano fango  
(opz.8860)  
mud (opt.8860)  
mud back panel and  
shelf (opt.8860)



visone (opz.948M)  
schiena e ripiano visone  
(opz.948M)  
mink (opt.948M)  
mink back panel and shelf  
(opt.948M)



### LUBE ECOLOGIC

IL GRUPPO LUBE HA SCELTO DI UTILIZZARE PER I COMPONENTI COSTITUENTI LE STRUTTURE DELLE CUCINE SOLO MATERIALE A BASSISSIMA EMISSIONE DI FORMALDEIDE: CONFORMI ALLO STANDARD F\*\*\*\* SECONDO LA NORMA JIS, CERTIFICATO DAL MINISTERO GIAPPONESE, IL PIU' SEVERO IN MERITO ALLE NORMATIVE DI SALVAGUARDIA AMBIENTALE.

LUBE GROUP HAS CHOSEN TO EXCLUSIVELY USE MATERIALS WITH VERY LOW FORMALDEHYDE EMISSIONS FOR THE COMPONENTS MAKING UP THE KITCHEN CARCASSES: THESE ELEMENTS COMPLY WITH THE F4 STAR STANDARD ACCORDING TO JIS, CERTIFIED BY THE JAPANESE GOVERNMENT - THE MOST STRINGENT WHEN IT COMES TO ENVIRONMENTAL PROTECTION.

## mensole in laminato P 31-61 come strutture same colours as carcasses laminated shelves D 31-61



bianco (opz.001)  
white (opt.001)



perla d'oriente (opz.940)  
oriental pearl (opt.940)



fango (opz.8860)  
mud (opt.8860)



visone (opz.948M)  
mink (opt.948M)



lavagna (opz.9620)  
slate grey (opt.9620)

**NEW**

**NEW**



argilla (opz.9690)  
clay (opt.9690)



conchiglia (opz.8910)  
shell (opt.8910)

## mensole impialacciate veneered shelves



impialacciata come anta  
N.B.: per le finiture vedi pagina 20  
veneered same finish as door  
Note: for the finishes see page 20

## mensole fenix fenix shelves



fenix come anta  
N.B.: per le finiture vedi pagina 24  
fenix as door  
Note: for the finishes see page 24

## mensole laccate lacquered shelves



laccate opache e lucide come anta  
N.B.: per le finiture vedi pagine 34-35  
matt and glossy lacquered as door  
Note: for the finishes see pages 34-35

## mensole laccate vintage vintage lacquered shelves



laccate vintage come anta  
N.B.: per le finiture vedi pagina 38  
vintage lacquered as door  
Note: for the finishes see page 38

## zoccoli in alluminio H 6 aluminium plinth H 6

di serie  
standard



alluminio finitura titanio  
ossidato (opz.414)  
aluminium titanium  
oxidized finish (opt.414)

**N.B.: ABBINAMENTO CONSIGLIATO  
CON L'ANTA BRONZO BRUNITO  
NOTE: BEST MATCHING WITH THE  
BURNISHED BRONZE DOOR**

## zoccoli in alluminio H 6 aluminium plinth H 6

a richiesta  
on request



alluminio finitura urban  
ossidato (opz.NU)  
aluminium urban  
oxidized finish (opt.NU)



alluminio  
finitura brill (opz.412)  
aluminium  
brill finish (opt.412)

**NEW**



alluminio finitura rame  
anticato (opz.422)  
aluminium antique  
copper finish  
(opt.422)

**NEW**



alluminio finitura  
grafite (opz.421)  
aluminium graphite  
finish (opt.421)

**NEW**



alluminio finitura nichel  
(opz.420)  
aluminium nickel  
finish (opt.420)

**NEW**



alluminio finitura  
bronzo anticato  
(opz.423)  
aluminium antique  
bronze finish (opt.423)

## zoccoli in alluminio H 6 verniciati a polvere finitura opaca aluminum plinth height H 6 powder coated matt finish



alluminio finitura nero  
(opz.7892)  
aluminium  
black finish (opt.7892)



alluminio finitura fumo  
(opz.9531)  
aluminium  
smoke finish  
(opt.9531)



alluminio finitura  
bianco caldo (opz.7401)  
aluminium warm white  
finish (opt.7401)



alluminio finitura  
bianco assoluto (opz.740S)  
aluminium absolute  
white finish (opt.740S)



alluminio finitura  
verde positano  
(opz.8471)  
aluminium positano  
green finish (opt.8471)



alluminio finitura  
acquamarina  
(opz.8323)  
aluminium  
aquamarine finish  
(opt.8323)



alluminio finitura  
castoro (opz.8907)  
aluminium beaver  
finish (opt.8907)



alluminio finitura rosso  
toscano (opz.8157)  
aluminium tuscan red  
finish (opt.8157)



alluminio finitura grigio  
bromo (opz.9533)  
aluminium bromine  
grey finish (opt.9533)



alluminio finitura  
silver dark (opz.9507)  
aluminium dark silver  
finish (opt.9507)



alluminio finitura  
argilla (opz.9503)  
aluminium clay  
finish (opt.9503)

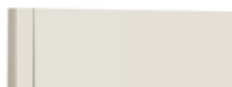

alluminio finitura  
conchiglia (opz.7403)  
aluminium shell  
finish (opt.7403)



alluminio finitura  
ghisa (opz.9509)  
aluminium cast iron  
finish (opt.9509)



alluminio bistro  
(opz.9535)  
aluminium bistro  
finish (opt.9535)



alluminio finitura  
grigio selce (opz.SE)  
aluminium flint grey  
finish (opt.SE)

# MODULARITÀ E COMPONIBILITÀ MODULARITY AND FITTING SOLUTIONS

- ESCLUSO 65 \* SOLO 90 ONLY 90
- ESCLUSO 65 EXCLUDING 65
- ESCLUSO 45 EXCLUDING 45
- ESCLUSO 45 EXCLUDING 45
- ESCLUSO 120 EXCLUDING 120

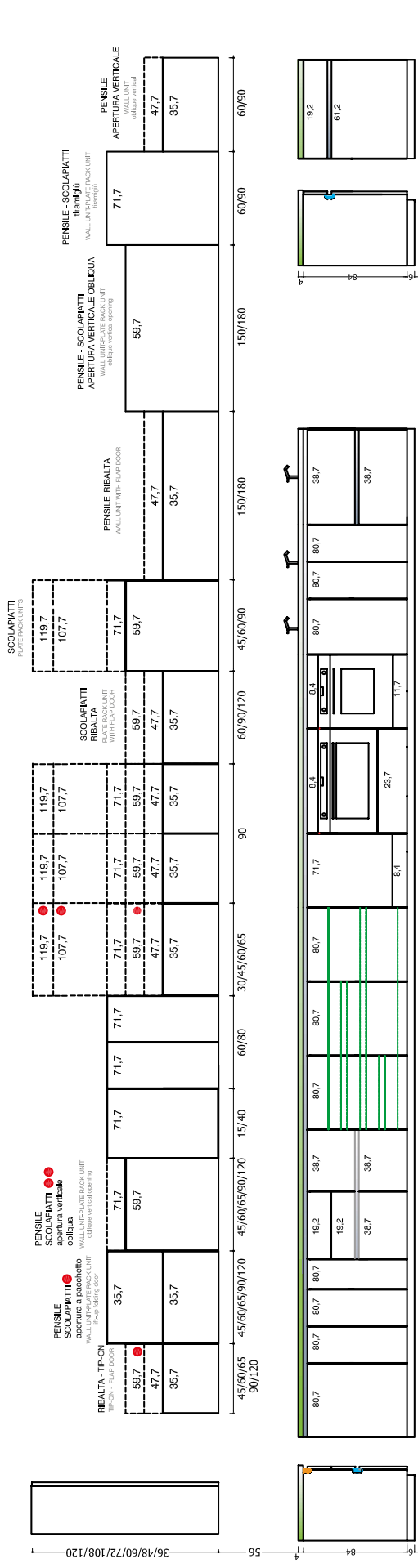

**BASH 75**  
BASE UNIT WITH 75

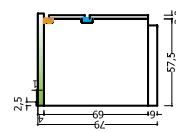

**BASI SOSPENSE**  
HANGING BASE UNITS

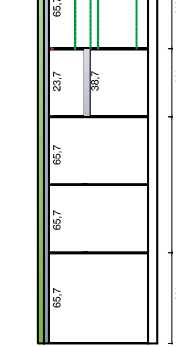

**BASI LIVING**  
ROOM UNITS

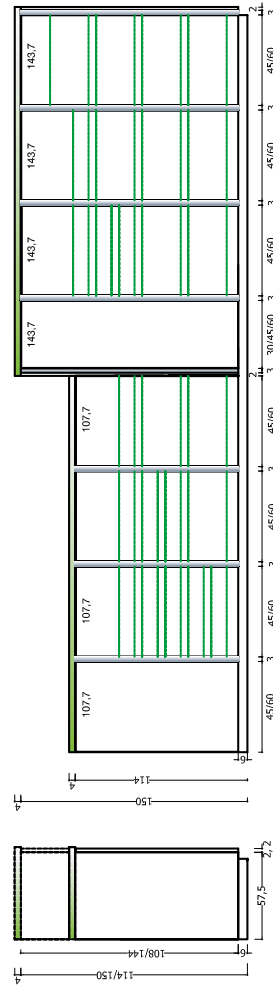
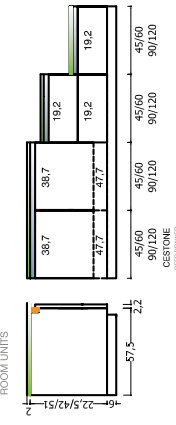



# MECCANISMI MOTORIZZATI SERVO-DRIVE

SERVO-DRIVE MOTORISED  
MECHANISMS

**Estrema facilità di apertura e chiusura ante**  
Extreme ease in opening and closing the doors

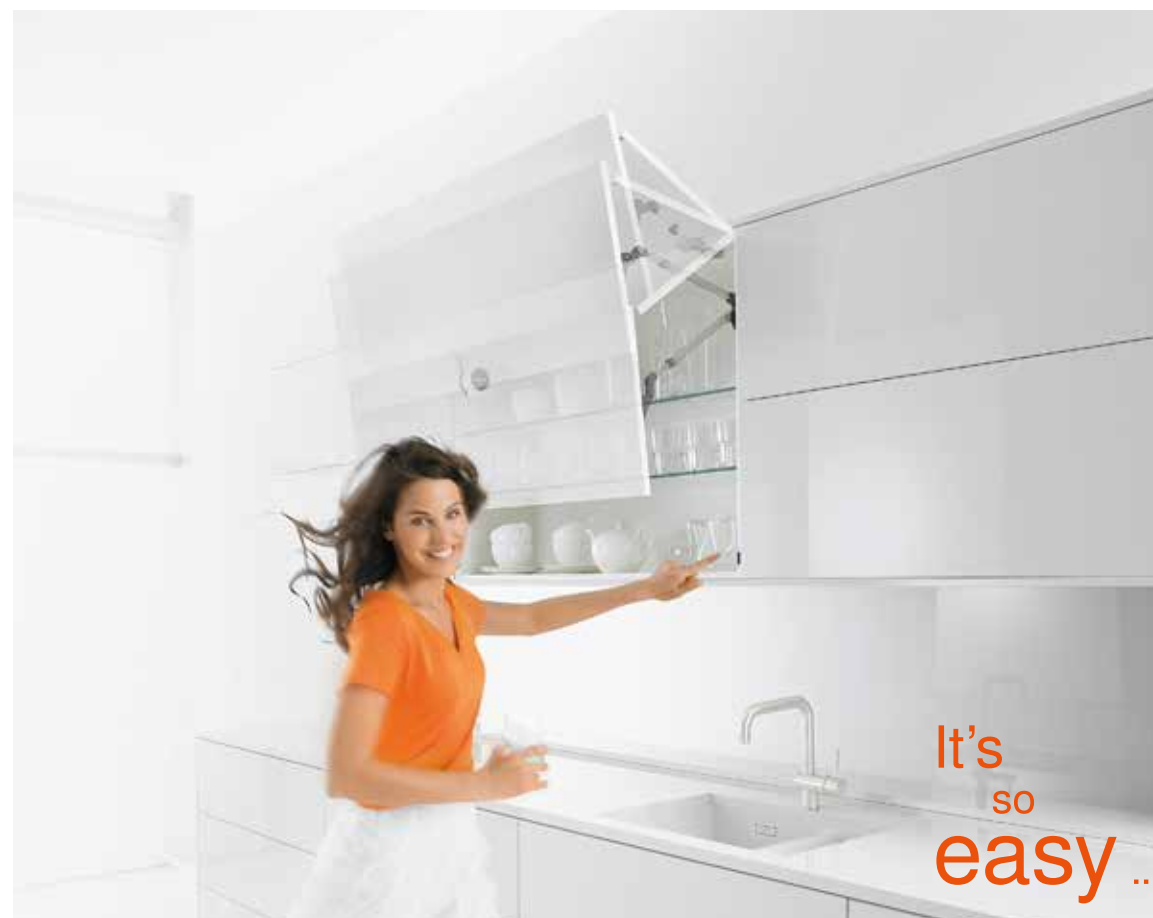

# OLTRE

**N.B.: il SERVO-DRIVE non può essere installato successivamente ma deve essere richiesto contemporaneamente all'ordine del pensile. Motorizzato SERVO-DRIVE (Opz.007)**

NOTE: SERVO-DRIVE cannot be installed at a later date but must be ordered at the same time with the wall unit. SERVO-DRIVE motorised (Opt.007)

**APERTURA ANTE A PACCHETTO**  
LIFT-UP FOLDING DOOR OPENING



**APERTURA VERTICALE OBLIQUA**  
OBLIQUE VERTICAL OPENING



**APERTURA RIBALTA**  
FLAPDOOR OPENING



**APERTURA VERTICALE**  
VERTICAL OPENING





# ESTREMAMENTE FACILE DA UTILIZZARE

EXTREMELY EASY TO USE

# OLTRE



Grazie a **SERVO-DRIVE** basta una leggera pressione sul fronte con la mano o il gomito per aprire automaticamente le ante a ribalta.

Persino i frontali grandi e pesanti si aprono verso l'alto come in totale assenza di gravità. Inoltre, l'utilizzatore della cucina può godere di un accesso ottimale all'interno del mobile.

Thanks to **SERVO-DRIVE**, just apply light pressure to the front panel with the hand or elbow to automatically open the folding doors.

Even large front panels open upwards with a complete lack of gravity. In addition, the opening provides optimum access to the cabinet interior.



Chiusura comoda e semplice, assicurata dall'interruttore facilmente raggiungibile, montato sul fianco del corpo mobile.

Le chiusure delle ante a ribalta risulta così estremamente comoda ed ergonomica, mentre la rinomata funzione **BLUMOTION** garantisce una chiusura dolce e silenziosa.

Simple and comfortable closure by using an easy-to-reach switch fitted on the side of the cabinet.

Closing the folding doors is so easy, comfortable and ergonomic. The renowned **BLUMOTION** function also ensures gentle and silent closing.



# KIT TRASFORMATORE

## POWER SUPPLY KIT

# OLTRE

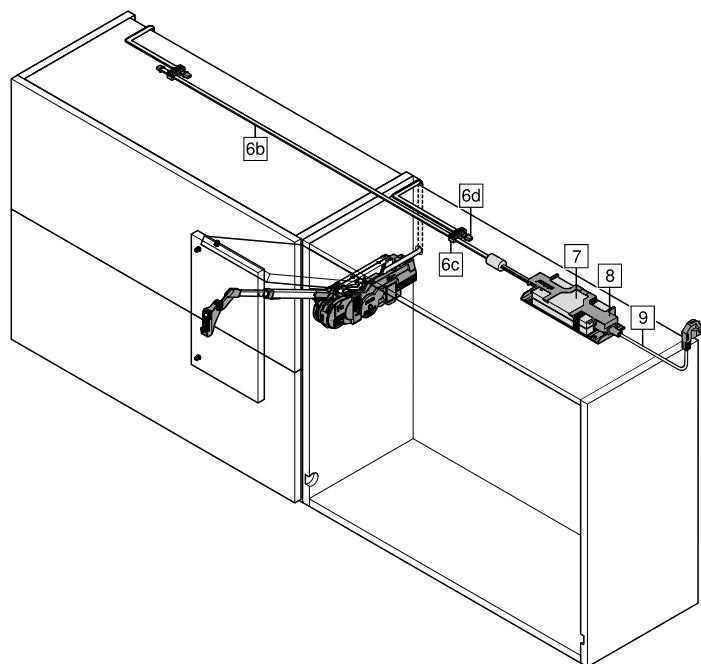

**Kit trasformatore composto da:**  
Power supply kit includes:

- 6b** Cavo di distribuzione lunghezza 8 mt  
Power supply cable length 8 m
  - 6c** 1 Connettore  
Connector
  - 6d** Protezione estremità cavo  
Cable end protection
  - 7** Trasformatore universale per tutti paesi del mondo  
72 W completo di supporto per il montaggio  
Universal power supply worldwide,  
72 W complete with mounting bracket
  - 8** Supporto trasformatore  
Power supply mounting bracket
  - 9** Cavo di alimentazione elettrica UE  
EU electrical power supply cable
- i** Per ogni cavo di distribuzione può essere collegato un solo trasformatore Blum.  
Only one Blum power supply may be connected to each power supply cable.

Per il meccanismo elettrico motorizzato SERVO-DRIVE richiedere sempre il kit trasformatore, codice 5615850 -  
Un trasformatore può alimentare fino a 10 motori.

**N.B.:** si potrebbero verificare situazioni dove occorre utilizzare più di un kit trasformatore.

For the motorised electric SERVO-DRIVE mechanism, always request the power supply kit: code 5615850 -

One power supply can power up to 10 motors.

NOTE: in some cases one may use more than one power supply kit.

### PENSILI SU PARETI CONTINUE

CONTINUOUS WALL UNITS

#### COMPOSIZIONE "A"

COMPOSITION "A"

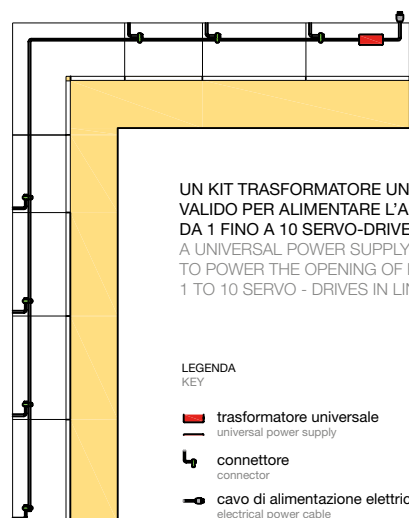

### PENSILI SU PARETI SEPARATE

SEPARATE WALL UNITS

#### COMPOSIZIONE "B"

COMPOSITION "B"

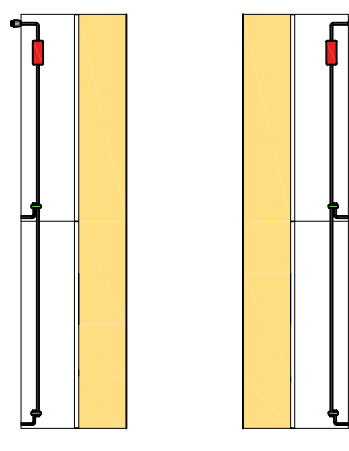

**APERTURA VERTICALE OBLIQUA**

I pensili con questo tipo di meccanismo necessitano per l'apertura di poco spazio libero sopra il mobile grazie al movimento basculante dell'anta che si apre senza difficoltà applicando poca forza anche in presenza di frontali pesanti. Con l'arresto progressivo le ante si fermano in qualsiasi posizione; in questo modo la maniglia è sempre facilmente raggiungibile. La chiusura è ammortizzata ed è possibile regolare la forza di tenuta in base al peso del frontale.

VERTICAL OPENING OBLIQUE

Wall units that mount this type of mechanism require little clearance above the cabinet thanks to the swivelling movement of the door that can be easily opened by applying slight pressure, even with heavy fronts. The doors stop in any position thanks to the gradual stopping movement; in this way, the handle is always easily accessible. The closing movement is cushioned and the closing force can be adjusted according to the weight of the front door.



**DI SERIE  
STANDARD**

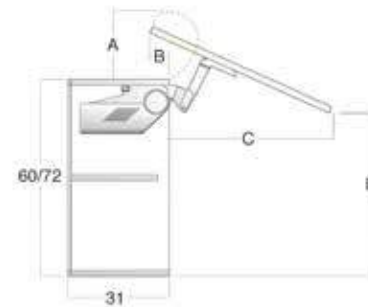

**MOTORIZZATO  
SERVO-DRIVE  
SERVO-DRIVE  
MOTORISED  
(Opz.007)**

	A	B	C	D
H 60	18	9,6	46,5	53,5
H 72	18	9,6	57	61

## APERTURA VERTICALE

L'anta ad apertura verticale, potendo essere sollevata completamente verso l'alto, consente un accesso totale all'interno del pensile. Ideale per l'impiego in mobili a colonna per nascondere ad esempio apparecchi elettrici, o pensili con corpi mobili sovrastanti, ha la chiusura ammortizzata e la possibilità di regolare la forza di tenuta in base al peso del frontale.

### VERTICAL OPENING

Doors with vertical opening movement can be fully raised to fully access the inside of the wall unit.

Ideal for use on column units to conceal electrical appliances for examples, or on wall units surmounted by mobile units.

The closing movement is cushioned and the closing force can be adjusted according to the weight of the front door.



**DI SERIE  
STANDARD**



**MOTORIZZATO  
SERVO-DRIVE  
SERVO-DRIVE  
MOTORISED  
(Opz.007)**

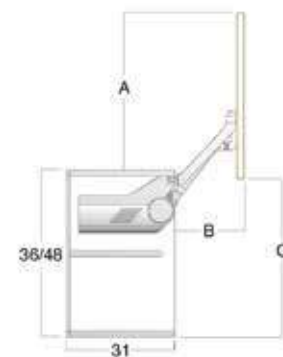

	A	B	C	
H 36	34	23,5	34,5	
H 48	43	28,5	43,5	

## PENSILE CON APERTURA ANTE A PACCHETTO

Il meccanismo d'apertura ante a pacchetto è idoneo sul pensile H 72; la regolazione della forza di apertura può essere impostata in modo esatto in base ai pesi dei frontali, la chiusura è ammortizzata e la cerniera centrale clip si contraddistingue per l'innovativa tecnologia che garantisce la sicurezza per le dita.

### WALL UNIT WITH LIFT-UP FOLDING DOORS

The lift-up folding door opening mechanism is suitable for wall units with H 72; the opening force can be adjusted precisely according to the weight of the fronts, while the closing movement is cushioned and the central clip-on hinge features innovative technology for safeguarding the fingers.



**DI SERIE  
STANDARD**



**MOTORIZZATO  
SERVO-DRIVE  
SERVO-DRIVE  
MOTORISED**

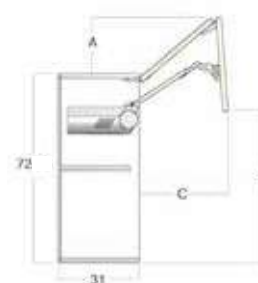

	A	B	C	
H 72	16,5	54	41	

**SCHEMA MONTAGGIO  
LIMITATORE  
LIMITER INSTALLATION  
DIAGRAM**

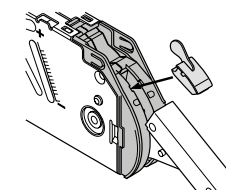

**Per evitare l'interferenza dell'anta in fase di apertura con cornici o mensole, si può richiedere il limitatore dell'angolo di apertura cod. 5620005**

In order to avoid that the door interferes with cornices or shelves during the opening movement, it is possible to request an opening angle limiter: code 5620005

## PENSILE CON APERTURA A RIBALTA

Le ante aprendosi verso l'alto consentono di avere un' ampia visione d'insieme all'interno del mobile. In questo modo è possibile un comodo accesso agli oggetti contenuti al suo interno e, dal punto di vista ergonomico, molto vantaggioso. La regolazione della forza di apertura può essere impostata in modo esatto in base al peso del frontale. Grazie all'arresto progressivo le ante si fermano in qualsiasi posizione; in questo modo la maniglia è sempre facilmente raggiungibile. La chiusura è ammortizzata e un'unica manovra è sufficiente per regolare il frontale tridimensionalmente grazie all'assenza di cerniere e al sistema di aggancio clip.

### WALL UNIT WITH FLAP DOOR

The doors that open upwards guarantee ample overall visibility inside the cabinet. In this way, all objects housed inside the cabinet can be comfortably accessed, making the system highly advantageous from an ergonomic perspective. The opening force can be adjusted precisely according to the weight of the front. The doors stop in any position thanks to the gradual stopping movement; in this way, the handle is always easily accessible. The closing movement is cushioned and a single manoeuvre is required to three-dimensionally adjust the front, thanks to the clip-on system and the absence of hinges.



### DI SERIE STANDARD

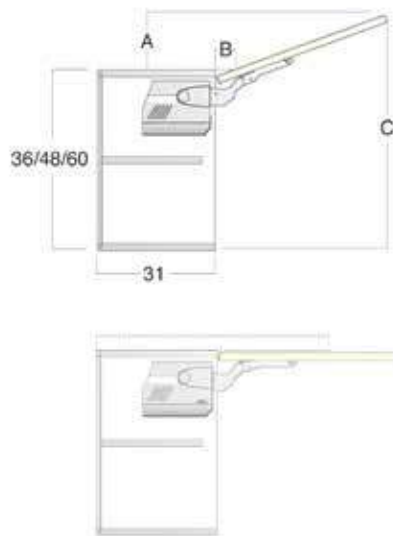

	A	B	C
H 36	11,5	3,5	37
H 48	15	3,5	49
H 60	18,5	3,5	61

### MOTORIZZATO SERVO-DRIVE SERVO-DRIVE MOTORISED (Opz.007)



### SCHEMA MONTAGGIO LIMITATORE PER RIBALTA H 36 FLAP DOOR LIMITER INSTALLATION DIAGRAM H 36

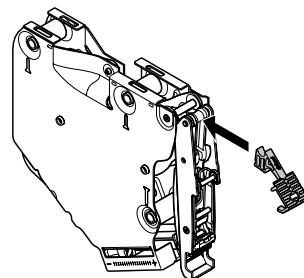

Per evitare l'interferenza dell'anta in fase di apertura con cornici o mensole, si può richiedere il limitatore dell'angolo di apertura cod. 5620010

In order to avoid that the door interferes with cornices or shelves during the opening movement, it is possible to request an opening angle limiter: code 5620010

### SCHEMA MONTAGGIO LIMITATORE PER RIBALTA H 48 FLAP DOOR LIMITER INSTALLATION DIAGRAM H 48

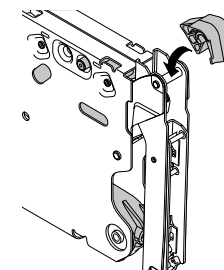

## COLONNE ARMADIO “NOOK” H 222 P 70,4 CON ANTE RIENTRANTI

“NOOK” CLOSET COLUMNS H 222 D 70,4 WITH DOORS INWARDS

Le colonne armadio “Nook” con ante a scomparsa, consentono di inserire all’interno forno, frigo, tavolo e cassetti

“Nook” closet columns with pull-out doors allow to insert oven, fridge, table and drawer on the inside



## COLONNE ARMADIO “NOOK” H 222 P 70,4 CON ANTE RIENTRANTI

“NOOK” CLOSET COLUMNS H 222 D 70,4 WITH DOORS INWARDS

Il tavolo estraibile è disponibile nella versione inox o in laminato, nella finitura oak cognac

The pull-out table it's available in stainless steel version or laminate oak cognac finish



LA COLLEZIONE BRIDGE DEL PROGRAMMA  
OLTRE PRESENTA UNA GRANDE VARIETA' DI  
MANIGLIE, DI VARIE FORME,  
MATERIALI, DIMENSIONI E FINITURE,  
CREATE AD HOC PER DARE UNICITA'  
E PERSONALITA' AD OGNI CUCINA.

THE BRIDGE COLLECTION OF OLTRE PROGRAM PROPOSE A WIDE  
RANGE OF HANDLES, IN VARIOUS FORMS,  
MATERIALS, DIMENSIONS AND FINISHES,  
SPECIFICALLY CREATED TO GIVE UNIQUENESS AND PERSONALITY  
TO EACH KITCHEN.

# OLTRE

## Bridge



**FRONTALE**  
anta con maniglia frontale  
door with front handle



**IN TESTA**  
anta con maniglia in testa  
door with top mounted handle



**FUSION**  
anta con maniglia integrata  
door with built-in handle

ANTA SQUADRATA  
CON MANIGLIA  
SQUARE DOOR WITH HANDLE





# I MODELLI BRIDGE POSSONO ESSERE REALIZZATI ANCHE SENZA MANIGLIA CON DIVERSE TIPOLOGIE DI APERTURE.

BRIDGE MODELS CAN BE REALIZED ALSO WITHOUT HANDLE AND SEVERAL TYPES OF OPENINGS.

## PENSILI APERTURA PRESA SU FONDO WALL UNITS WITH GRIP ON BOTTOM OPENING



PARTICOLARE PRESA SU FONDO  
DETAIL WITH GRIP ON BOTTOM

## ANTA PUSH-PULL PER BASI E COLONNE PUSH-PULL DOOR FOR BASE UNITS AND COLUMNS

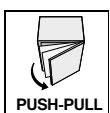

MECCANISMO PUSH-PULL  
PUSH-PULL MACHNISM

## CASSETTO E CESTONE TIP-ON DRAWER AND DEEP DRAWER TIP-ON

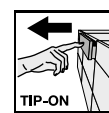

MECCANISMO TIP-ON  
TIP-ON MACHNISM

## LAVASTOVIGLIE CON SERVO-DRIVE FLEX DISHWASHER WITH FLEX SERVO-DRIVE



MECCANISMO SERVO-DRIVE  
SERVO-DRIVE MACHNISM

## FRIGO CON SERVO-DRIVE FLEX FRIDGE WITH FLEX SERVO-DRIVE



MECCANISMO SERVO-DRIVE  
SERVO-DRIVE MACHNISM

**CARATTERISTICHE TECNICHE****ANTE E FRONTALI  
CASSETTI**

anta sp.22 mm impiallacciata **rovere vintage con nodi e stuccature venatura verticale finitura materica** nei colori:  
 rovere bianco invecchiato (opz.5380), rovere juta invecchiato (opz.5381), rovere corteccia invecchiato (opz.5382),  
 rovere mielato invecchiato (opz.5383), rovere antracite invecchiato (opz.5384), rovere argilla invecchiato (opz.5385),  
 rovere moro invecchiato (opz.5386), rovere naturale invecchiato parquetato (opz.5387), rovere grigio terra (opz.5389),  
 rovere madera termocotto con finto tarlo (opz.5388)

**MANIGLIE**

vedi pag.206-215

**STRUTTURE****ANTE: rovere argilla invecchiato**

di serie : nobilitato bianco (opz.001) schiena e ripiano bianco (opz.001)

**ANTE: rovere bianco invecchiato, rovere juta invecchiato**

di serie : nobilitato visone (opz.948M) schiena e ripiano visone (opz.948M)

**ANTE: rovere antracite invecchiato**

di serie : nobilitato lavagna (opz.9620) schiena e ripiano lavagna (opz.9620)

**ANTE: rovere corteccia invecchiato, rovere mielato invecchiato, rovere moro invecchiato,  
rovere naturale parquetato, rovere madera termocotto, rovere grigio terra**

di serie : nobilitato fango (opz.8860) schiena e ripiano fango (opz.8860)

a richiesta : nobilitato perla d'oriente (opz.940) schiena e ripiano bianco (opz.001)  
 nobilitato conchiglia (opz.8910) schiena e ripiano conchiglia (opz.8910)  
 nobilitato argilla (opz.9690) schiena e ripiano argilla (opz.9690)

**MENSOLE**

**di serie:** altezza cm 3,8 in laminato come strutture: bianco (opz.001), perla d'oriente (opz.940),  
 visone (opz.948M), lavagna (opz.9620), fango (opz.8860), argilla (opz.9690), conchiglia (opz.8910)

**a richiesta:** altezza cm 3,8 impiallacciata finiture come ante

**ZOCCOLI**

vedi pag.221



TH. 22 MM

**OLTRE** Bridge**TECHNICAL FEATURES****DOORS AND  
DRAWER FRONTS**

22 mm th. veneered door **vintage oak with knots and filler vertical grain textured finish** in the following colours:  
white aged oak (opt.5380), jute aged oak (opt.5381), bark aged oak (opt.5382), honey aged oak (opt.5383),  
anthracite aged oak (opt.5384), clay aged oak (opt.5385), dark aged oak (opt.5386), parquet-effect natural aged oak (opt.5387)  
grey earth oak (opt.5389), heat treated madera oak with worm-eaten effect (opt.5388)

**HANDLES**

[see page 206-215](#)

**STRUCTURES****DOORS: clay aged oak**

**standard:** melamine-coated white (opt.001), white back panel and shelf (opt.001)

**DOORS: white aged oak, jute aged oak**

**standard:** melamine-coated mink (opt.948M), mink back panel and shelf (opt.948M)

**DOORS: anthracite aged oak**

**standard:** melamine-coated slate grey (opt.9620), slate grey back panel and shelf (opt.9620)

**DOORS: bark aged oak, honey aged oak, dark aged oak, parquet-effect natural aged oak, heat treated madera oak, grey earth oak**

**standard:** melamine-coated mud (opt.8860), mud back panel and shelf (opt.8860)

**on request:** melamine-coated oriental pearl (opt.940), white back panel and shelf (opt.001)

melamine-coated shell (opt.8910), shell back panel and shelf (opt.8910)

melamine-coated clay (opt.9690), clay back panel and shelf (opt.9690)

**SHELVES**

**standard:** height 3.8 cm, in laminate to match structure: white (opt.001), oriental pearl (opt.940),  
mink (opt.948M), slate grey (opt.9620), mud (opt.8860), clay (opt.9690), shell (opt.8910)

**on request:** height 3.8 cm, veneered to match doors

**PLINTHS**

[see page 221](#)

# OLTRE **B**ridge

**SP. 22 MM TH. 22 MM**

anta finitura materica vintage  
door with textured vintage finish



rovere bianco invecchiato  
(opz.5380)  
white aged oak (opt.5380)



rovere juta invecchiato  
(opz.5381)  
jute aged oak (opt.5381)



rovere corteccia invecchiato  
(opz.5382)  
bark aged oak (opt.5382)



rovere mielato invecchiato  
(opz.5383)  
honey aged oak (opt.5383)



rovere antracite invecchiato  
(opz.5384)  
anthracite aged oak  
(opt.5384)



rovere argilla invecchiato  
(opz.5385)  
clay aged oak (opt.5385)



rovere moro invecchiato  
(opz.5386)  
dark aged oak (opt.5386)



rovere naturale invecchiato  
parquettato (opz.5387)  
parquet-effect natural aged  
oak (opt.5387)



rovere mader termocotto  
con finto tarlo (opz.5388)  
heat treated mader oak with  
worm-eaten effect (opt.5388)



particolare anta con finto tarlo  
door with worm-eaten effect detail



rovere grigio terra (opz.5389)  
grey earth oak (opt.5389)



SP. 22 MM

**OLTRE** Bridge**CARATTERISTICHE TECNICHE****ANTE E FRONTALI  
CASSETTI**

anta sp.22 mm con pannello in truciolare E1 rivestito lato esterno con fenix spessore 9/10 lato interno in laminato spessore 9/10 in tinta come esterno, bordata in polipropilene con incollaggio laser spessore 10/10, nei colori:  
bianco caldo (opz.7446), castoro (opz.8864), nero (opz.7861), grigio bromo (opz.9628), fumo (opz.9629), cacao orinoco (opz.8865), beige arizona (opz.7705), grigio efeso (opz.9630), blu fes (opz.8301), bianco dover (opz.7449)

**MANIGLIE**

vedi pag.206-215

**STRUTTURE****ANTE: bianco caldo, bianco dover**

di serie : nobilitato bianco (opz.001) schiena e ripiano bianco (opz.001)

**ANTE: fumo, beige arizona**

di serie : nobilitato visone (opz.948M) schiena e ripiano visone (opz.948M)

**ANTE: nero, grigio bromo, blu fes**

di serie : nobilitato lavagna (opz.9620) schiena e ripiano lavagna (opz.9620)

**ANTA: castoro**

di serie : nobilitato conchiglia (opz.8910) schiena e ripiano conchiglia (opz.8910)

**ANTA: cacao orinoco**

nobilitato fango (opz.8860) schiena e ripiano fango (opz.8860)

**ANTA: grigio efeso**

nobilitato argilla (opz.9690) schiena e ripiano argilla (opz.9690)

a richiesta : nobilitato perla d'oriente (opz.940) schiena e ripiano bianco (opz.001)

**MENSOLE**

di serie: altezza cm 3,8 in laminato come strutture: bianco (opz.001), perla d'oriente (opz.940), visone (opz.948M), lavagna (opz.9620), fango (opz.8860), argilla (opz.9690), conchiglia (opz.8910)

a richiesta: altezza cm 3,8 finiture come ante

**ZOCCOLI**

vedi pag.221



TH. 22 MM

**OLTRE** Bridge**TECHNICAL FEATURES****DOORS AND  
DRAWER FRONTS**

22 mm th. door with E1 chipboard panel with exterior coated in 9/10 thickness Fenix and interior in 9/10 thickness laminate in the same colour as the exterior. Edge in 10/10 thickness polypropylene with laser gluing, in the following colours:  
warm white (opt.7446), beaver (opt.8864), black (opt.7861), bromine grey (opt.9628), smoke (opt.9629),  
cocoa orinoco (opt.8865), arizona beige (opt.7705), ephesus grey (opt.9630), blue fes (opt.8301), dover white (opt.7449)

**HANDLES**

[see page 206-215](#)

**STRUCTURES**

**DOORS: warm white, dover white**  
standard: melamine-coated white (opt.001), white back panel and shelf (opt.001)  
**DOORS: smoke, arizona beige**  
standard: melamine-coated mink (opt.948M), mink back panel and shelf (opt.948M)  
**DOORS: black, bromine grey, fles blue**  
standard: melamine-coated slate grey (opt.9620), slate grey back panel and shelf (opt.9620)  
**DOOR: beaver**  
standard: melamine-coated shell (opt.8910), shell back panel and shelf (opt.8910)  
**DOOR: orinoco cocoa**  
standard: melamine-coated mud (opt.8860), mud back panel and shelf (opt.8860)  
**DOOR: ephesus grey**  
standard: melamine-coated clay (opt.9690), clay back panel and shelf (opt.9690)

**on request:** melamine-coated oriental pearl (opt.940), white back panel and shelf (opt.001)

**SHELVES**

**standard:** height 3.8 cm, in laminate to match structure: white (opt.001) oriental pearl (opt.940),  
mink (opt.948M), slate grey (opt.9620), mud (opt.8860), clay (opt.9690), shell (opt.8910)

**on request:** height 3.8 cm, finished to match doors

**PLINTHS**

[see page 221](#)

**SP. 22 MM TH. 22 MM**

# OLTRE **B**ridge

anta finitura fenix

door with fenix finish

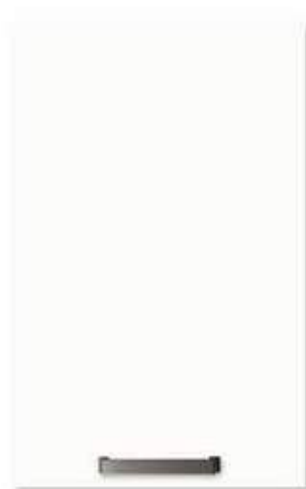

bianco caldo (opz.7446)  
warm white (opt.7446)



castoro (opz.8864)  
beaver (opt.8864)

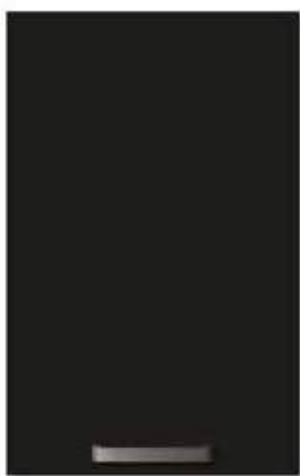

nero (opz.7861)  
black (opt.7861)



grigio bromo (opz.9628)  
bromine grey (opt.9628)



fumo (opz.9629)  
smoke (opt.9629)



cacao orinoco (opz.8865)  
cocoa orinoco (opt.8865)



beige arizona (opz.7705)  
arizona beige (opt.7705)



grigio efeso (opz.9630)  
ephesus grey (opt.9630)



blu fes (opz.8301)  
blue fes (opt.8301)

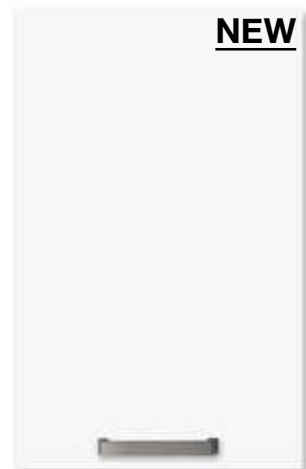

bianco dover (opz.7449)  
dover white (opt.7449)



# Informazioni tecniche

## FENIX NTM™

È un nuovissimo prodotto per l'interior design sviluppato da Arpa Industriale.

Prodotto grazie a resine di nuova generazione, questo materiale intelligente si contraddistingue per una superficie dalle proprietà straordinarie.

Con una bassa riflessione della luce, la sua superficie è estremamente opaca (valore di riflessione speculare: 1,5 e 60°) e anti impronte digitali.

Grazie all'utilizzo della nanotecnologia, eventuali micrograffi possono essere riparati termicamente ed è inoltre piacevolmente soft touch.

FENIX NTM™ è Made in Italy.

FENIX NTM™ è un materiale innovativo di Arpa Industriale creato per l'interior design prodotto mediante

l'applicazione simultanea di calore (circa 150°C) e alta pressione specifica (> 7 MPa) per ottenere un prodotto omogeneo non poroso con densità elevata.

Il suo core è composto da carta impregnata in resina termoindurente mentre la superficie decorativa, ottenuta con l'ausilio di nanotecnologie, è costituita da una carta decorativa trattata con resine di nuova generazione frutto della ricerca di Arpa Industriale.

FENIX NTM™ è un materiale che si distingue per particolari caratteristiche quali: alta resistenza al graffio e al calore, anti impronta, morbidezza al tatto, bassa riflessione della luce, riparabilità termica dei micrograffi, alta attività di abbattimento della carica batterica.

FENIX NTM™ è un marchio registrato da Arpa Industriale.

FENIX NTM™ è placcato su truciolare idrorepellente e il top è bordato sui lati a vista con polipropilene spessore 1 mm in tinta.

# Technical information

## FENIX NTM™

It is a brand new interior design product developed by Arpa Industriale.

Using the most modern resins, this intelligent material stands out for the extraordinary characteristics of its surface.

The matt surface has an exceptionally low reflectivity (specular reflection index: 1.5 and 60°) and is highly resistant to hand and finger prints.

The material uses nanotechnology to enable micro-scratches to be healed thermally, and it also has a very pleasant soft touch effect.

FENIX NTM™ is Made in Italy.

FENIX NTM™ is an innovative interior design product from Arpa Industriale, made by applying heat (around 150°C) and high pressure (> 7 MPa) to obtain a non-porous very dense material.





















Its core is composed of paper impregnated with thermosetting resin, while the surface, which employs nanotechnology processes, is composed of a decorative paper treated with the most recently developed resins from the Arpa Industriale research labs.

FENIX NTM™ stands out for its exceptional resistance to scratching, heat and hand and finger prints, soft touch, low reflectivity, thermal healing of micro-scratches, and effective anti-bacterial action.

FENIX NTM™ is a registered trademark of Arpa Industriale.

FENIX NTM™ is fixed on waterproof fiberboard and the top is trimmed on visible sides with 1 mm polypropylene in matching colour.

## FENIX NTM™

- |   |  |   |  |
|---|--|---|--|
|    | <b>Resistenza ai graffi e all'abrasione</b><br>Resistance to scratches and abrasion                                |    | <b>Stabilità dimensionale in presenza di elevata variazione termica</b><br>Dimensional stability even at high temperature changes    |
|    | <b>Alta attività di abbattimento della carica batterica</b><br>Enhanced anti-bacterial properties                  |    | <b>Resistenza all'urto</b><br>Resistance to impact   |
|    | <b>Igienico</b><br>Hygienic  |    | <b>Stabilità alla luce</b><br>Lightfastness  |
|    | <b>Idoneo al contatto con gli alimenti</b><br>Suitable for contact with food                                       |    | <b>Resistenza al calore secco</b><br>Resistance to dry heat  |
|    | <b>Facile da pulire</b><br>Easy to clean   |    | <b>Eccellente intensità e profondità del colore</b><br>Excellent intensity and colour depth  |
|    | <b>Antimuffa</b><br>Mold-resistant   |    | <b>Resistenza allo strofinamento</b><br>Rub resistance   |
|  | <b>Antistatico</b><br>Antistatic   |  | <b>Elevata resistenza a solventi acidi e ai reagenti di uso domestico</b><br>High resistance to acid solvents and household reagents |
|  | <b>Idrorepellente</b><br>Water proof   |  | <b>Autoportante (solo per gli spessori 10 e 12 mm)</b><br>Self-supporting (only for 10 and 12 mm)                                    |
|  | <b>Bassa riflessione della luce, superficie estremamente opaca</b><br>Low light reflection, extremely matt surface |  | <b>Riparabilità termica dei micrograffi</b><br>Repairability thermal micro-scratches   |
|  | <b>Anti-impronta</b><br>Anti-huella digital  |  | <b>Morbidezza al tatto</b><br>Soft to the touch  |

## FENIX NTM™

**RIPARABILITÀ TERMICA DEI MICROGRAFFI**  
Nanotech matt material for interior design



**ISTRUZIONI PER LA MANUTENZIONE:**  
MAINTENANCE

**FERRO DA STIRO:**  
CLOTHES IRON

**ISTRUZIONI PER LA MANUTENZIONE:**  
MAINTENANCE

**SPUGNA DI SCHEUMA MELAMMINICA:**  
MELAMINE FOAM SPONGE

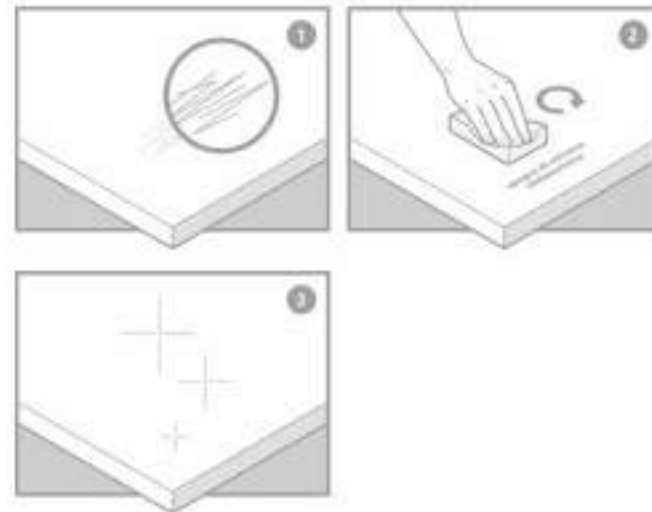
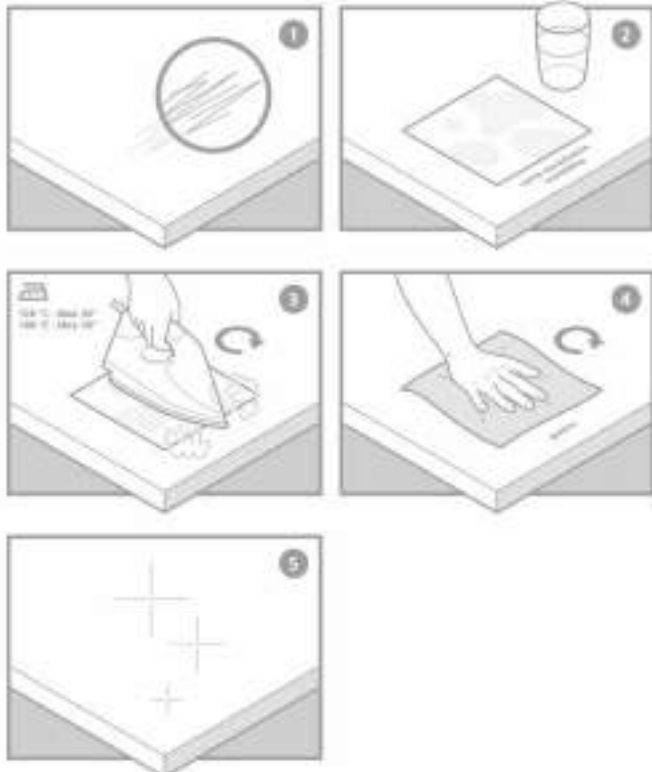

Visita [fenixntm.com](http://fenixntm.com)  
go to [fenixntm.com](http://fenixntm.com)

per scoprire tutte le proprietà  
for further details

made in Italy by Arpa Industriale

## CARATTERISTICHE TECNICHE

### ANTE E FRONTALI CASSETTI

anta sp.22 mm in mdf laccata **finitura opaca testurizzata soft nei colori:**

 [CLICCA QUI PER LA GAMMA COLORI DISPONIBILI](#)

 [CLICK HERE FOR THE RANGE OF AVAILABLE COLORS](#)

### MANIGLIE

[vedi pag.206-215](#)

### STRUTTURE

**di serie:** nobilitato bianco (opz.001) schiena e ripiano bianco (opz.001)

**a richiesta:** nobilitato visone (opz.948M) schiena e ripiano visone (opz.948M)  
 nobilitato lavagna (opz.9620) schiena e ripiano lavagna (opz.9620)  
 nobilitato perla d'oriente (opz.940) schiena e ripiano bianco (opz.001)  
 nobilitato fango (opz.8860) schiena e ripiano fango (opz.8860)  
 nobilitato conchiglia (opz.8910) schiena e ripiano conchiglia (opz.8910)  
 nobilitato argilla (opz.9690) schiena e ripiano argilla (opz.9690)



### MENSOLE

**di serie:** altezza cm 3,8 in laminato come strutture: bianco (opz.001), perla d'oriente (opz.940), visone (opz.948M), lavagna (opz.9620), fango (opz.8860), argilla (opz.9690), conchiglia (opz.8910)

**a richiesta:** altezza cm 3,8 laccate opache finiture come ante

### ZOCCOLI

[vedi pag.221](#)



cod. **284**

# Laccato Lucido Spazzolato

**SP. 22 MM**

# OLTRE **B**ridge

## CARATTERISTICHE TECNICHE

ANTE E FRONTALI  
CASSETTI

anta sp.22 mm in mdf laccata **finitura lucida spazzolata nei colori:**

 [CLICCA QUI PER LA GAMMA COLORI DISPONIBILI](#)

 [CLICK HERE FOR THE RANGE OF AVAILABLE COLORS](#)

MANIGLIE

[vedi pag.206-215](#)

STRUTTURE

**di serie:** nobilitato bianco (opz.001) schiena e ripiano bianco (opz.001)

**a richiesta:** nobilitato visone (opz.948M) schiena e ripiano visone (opz.948M)  
nobilitato lavagna (opz.9620) schiena e ripiano lavagna (opz.9620)  
nobilitato perla d'oriente (opz.940) schiena e ripiano bianco (opz.001)  
nobilitato fango (opz.8860) schiena e ripiano fango (opz.8860)  
nobilitato conchiglia (opz.8910) schiena e ripiano conchiglia (opz.8910)  
nobilitato argilla (opz.9690) schiena e ripiano argilla (opz.9690)



MENSOLE

**di serie:** altezza cm 3,8 in laminato come strutture: bianco (opz.001), perla d'oriente (opz.940), visone (opz.948M), lavagna (opz.9620), fango (opz.8860), argilla (opz.9690), conchiglia (opz.8910)

**a richiesta:** altezza cm 3,8 laccate opache finiture come ante

ZOCCOLI

[vedi pag.221](#)



TH. 22 MM

**OLTRE** Bridge**TECHNICAL FEATURES****DOORS AND  
DRAWER FRONTS**22 mm th. MDF door, with **soft textured matt lacquered finish in the following colours:**[CLICCA QUI PER LA GAMMA COLORI DISPONIBILI](#)[CLICK HERE FOR THE RANGE OF AVAILABLE COLORS](#)**HANDLES**[see page 206-215](#)**STRUCTURES****standard:** melamine-coated white (opt.001), white back panel and shelf (opt.001)**on request:** melamine-coated mink (opt.948M), mink back panel and shelf (opt.948M)  
melamine-coated slate grey (opt.9620), slate grey back panel and shelf (opt.9620)  
melamine-coated oriental pearl (opt.940), white back panel and shelf (opt.001)  
melamine-coated mud (opt.8860), mud back panel and shelf (opt.8860)  
melamine-coated shell (opt.8910), shell back panel and shelf (opt.8910)  
melamine-coated clay (opt.9690), clay back panel and shelf (opt.9690)**SHELVES****standard:** : height 3.8 cm, in laminate to match structure: white (opt.001) oriental pearl (opt.940), mink (opt.948M), slate grey (opt.9620), mud (opt.8860), clay (opt.9690), shell (opt.8910)**on request:** height 3.8 cm, matt lacquered finish to match doors**PLINTHS**[see page 221](#)

cod. **284**

# Brushed Glossy Lacquered

TH. 22 MM

# OLTRE **B**ridge

## TECHNICAL FEATURES

### DOORS AND DRAWER FRONTS

22 mm th. MDF door, with **brushed glossy lacquered finish in the following colours:**

[CLICCA QUI PER LA GAMMA COLORI DISPONIBILI](#)

[CLICK HERE FOR THE RANGE OF AVAILABLE COLORS](#)

### HANDLES

[see page 206-215](#)

### STRUCTURES

**standard:** melamine-coated white (opt.001), white back panel and shelf (opt.001)

**on request:** melamine-coated mink (opt.948M), mink back panel and shelf (opt.948M)  
melamine-coated slate grey (opt.9620), slate grey back panel and shelf (opt.9620)  
melamine-coated oriental pearl (opt.940), white back panel and shelf (opt.001)  
melamine-coated mud (opt.8860), mud back panel and shelf (opt.8860)  
melamine-coated shell (opt.8910), shell back panel and shelf (opt.8910)  
melamine-coated clay (opt.9690), clay back panel and shelf (opt.9690)

### SHELVES

**standard:** : height 3.8 cm, in laminate to match structure: white (opt.001) oriental pearl (opt.940), mink (opt.948M), slate grey (opt.9620), mud (opt.8860), clay (opt.9690), shell (opt.8910)

**on request:** height 3.8 cm, matt lacquered finish to match doors

### PLINTHS

[see page 221](#)

cod. **283**

Laccato Opaco  
Matt Lacquered

**SP. 22 MM TH. 22 MM**

ante laccate opache  
matt doors lacquered

OLTRE **B**ridge

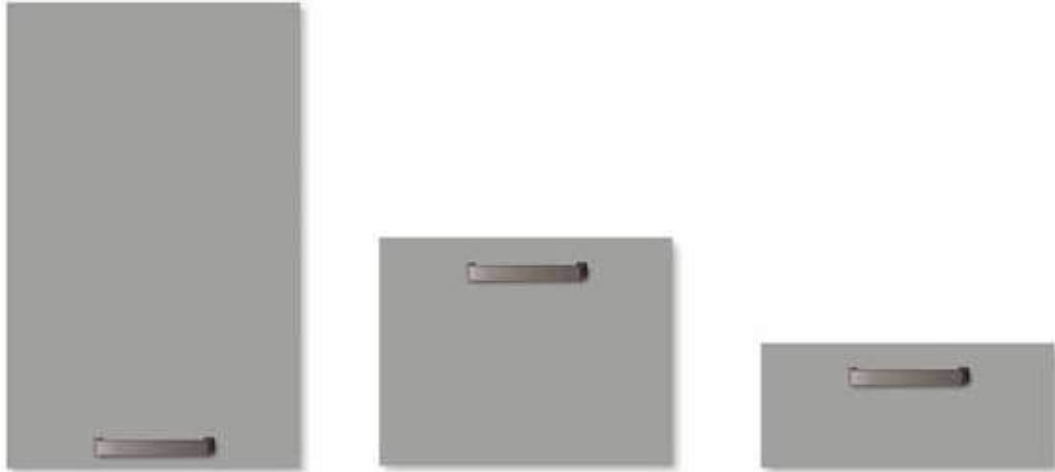

cod. **284**

# Laccato Lucido Spazzolato

Brushed Glossy Lacquered

**SP. 22 MM TH. 22 MM**

ante laccate lucide  
glossy doors lacquered

# OLTRE **B**ridge



**CARATTERISTICHE TECNICHE****ANTE E FRONTALI  
CASSETTI**

anta sp.22 mm in mdf laccata **finitura semilucida effetto metallo vintage** nei colori:  
peltro (opz.9549), ferro (opz.9506), bronzo (opz.8904)

anta sp.22 mm in mdf laccata **finitura semilucida effetto metallo vintage spazzolato** nei colori:  
bronzo anticato (opz.8909), rame anticato (opz.8159), nichel (opz.9505), bronzo brunito (opz.8903), grafite (opz.9508), urban (opz.7894)

**MANIGLIE**

**vedi pag.206-215**

**STRUTTURE**

**ANTE: peltro, ferro, urban, grafite**  
di serie: nobilitato lavagna (opz.9620) schiena e ripiano lavagna (opz.9620)

**ANTE: bronzo, rame anticato, bronzo brunito, bronzo anticato**  
di serie: nobilitato fango (opz.8860) schiena e ripiano fango (opz.8860)

**ANTA: nichel**  
di serie: nobilitato visone (opz.948M) schiena e ripiano visone (opz.948M)

**a richiesta:** nobilitato bianco (opz.001) schiena e ripiano bianco (opz.001)  
nobilitato perla d'oriente (opz.940) schiena e ripiano bianco (opz.001)  
nobilitato conchiglia (opz.8910) schiena e ripiano conchiglia (opz.8910)  
nobilitato argilla (opz.9690) schiena e ripiano argilla (opz.9690)

**MENSOLE**

**di serie:** altezza cm 3,8 in laminato come strutture: bianco (opz.001), perla d'oriente (opz.940), visone (opz.948M), lavagna (opz.9620), fango (opz.8860), argilla (opz.9690), conchiglia (opz.8910)

**a richiesta:** altezza cm 3,8 finiture come ante

**ZOCCOLI**

**vedi pag.221**





TH. 22 MM

**TECHNICAL FEATURES****DOORS AND  
DRAWER FRONTS**

22 mm th. door in mdf with **vintage metal effect semi-gloss lacquer finish** in the following colours:  
pewter (opt. 9549), iron (opt. 9506), bronze (opt. 8904)

22 mm th. door in mdf with **vintage metal effect semi-gloss lacquer brushed finish** in the following colours:  
antique bronze (opt. 8909), antique copper (opt. 8159), nickel (opt. 9505), burnished bronze (opt. 8903),  
graphite (opt. 9508), urban (opt. 7894)

**HANDLES**

[see page 206-215](#)

**STRUCTURES**

**DOORS: pewter, iron, urban, graphite**

**standard:** melamine-coated slate grey (opt.9620), slate grey back panel and shelf (opt.9620)

**DOORS: bronze, antique copper, burnished bronze, antique bronze**

**standard:** melamine-coated mud (opt.8860), mud back panel and shelf (opt.8860)

**DOOR: nickel**

**standard:** melamine-coated mink (opt.948M), mink back panel and shelf (opt.948M)

**on request:** melamine-coated white (opt.001), white back panel and shelf (opt.001)

melamine-coated oriental pearl (opt.940), white back panel and shelf (opt.001)

melamine-coated shell (opt.8910), shell back panel and shelf (opt.8910)

melamine-coated clay (opt.9690), clay back panel and shelf (opt.9690)

**SHELVES**

**standard:** : height 3.8 cm, in laminate to match structure: white (opt. 001) oriental pearl (opt. 940),  
mink (opt. 948M), slate grey (opt. 9620), mud (opt. 8860), clay (opt.9690), shell (opt.8910)

**on request:** height 3.8 cm, finished to match doors

**PLINTHS**

[see page 221](#)

OLTRE **B**ridge

SP. 22 MM TH. 22 MM

ante laccate vintage effetto metallo  
lacquered vintage doors metal effect



peltro (opz.9549)  
pewter (opt.9549)



ferro (opz.9506)  
iron opt.9506



bronzo (opz.8904)  
bronze (opt.8904)

ante laccate vintage effetto spazzolato  
lacquered vintage doors brushed effect



bronzo brunito (opz.8903)  
burnished bronze (opt.8903)



grafite (opz.9508)  
graphite (opt.9508)



nicel (opz.9505)  
nickel (opt.9505)



bronzo antico (opz.8909)  
antique bronze (opt.8909)



rame antico (opz.8159)  
antique copper (opt.8159)



urban (opz.7894)  
urban (opt.7894)

**abbinabile alle versioni: 280-281-282-283-284**

matched with versions: 280-281-282-283-284

di serie: telaio alluminio sp.22 mm verniciato a polvere nero,  
vetro temperato master line sp.4 mm (opz.NML)

standard: 22mm th. aluminium frame with black powder coating,  
4mm th. master line tempered glass (opt.NML)



particolare telaio svasatura esterna  
detail frame with external flared



particolare maniglia  
detail frame with handle

**SP. 22 MM TH. 22 MM**

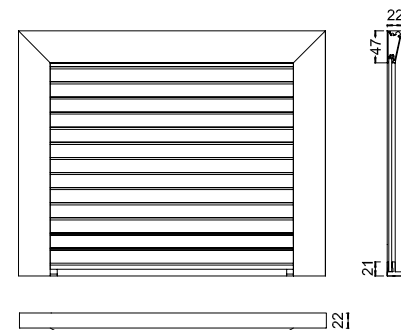

a richiesta: telaio alluminio sp.22 mm verniciato a polvere nero,  
vetro temperato bronzo o fumè trasparente sp.4 mm

on request: 22mm th. aluminium frame with black powder coating,  
4mm th. tempered bronze or smoked transparent glass

**NEW**

**NEW**



vetro bronzo (opz.NBZ)  
bronze glass (opt.NBZ)



vetro fumè (opz.NFUM)  
smoked glass (opt.NFUM)



particolare maniglia  
detail frame with handle

**SP. 22 MM TH. 22 MM**

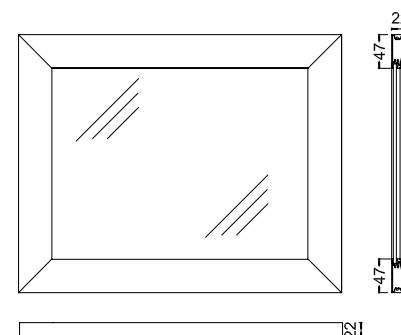

# Vetro Lucido e Satinato

## Glossy and Satin Glass

# OLTRE<sup>B</sup>ridge

abbinata a OLTRE Neck e Lux  
model matched with OLTRE Neck and Lux

**Nelle versioni OLTRE BRIDGE è possibile abbinare i vetri colorati delle versioni NECK e LUX**

The colored glossy of versions NECK and LUX is possible to match in BRIDGE OLTRE versions

## CARATTERISTICHE TECNICHE TECHNICAL FEATURES

Telaio alluminio sp.22 mm verniciato a polvere finitura opaca in tinta con il vetro, tamburato nella parte posteriore con pannello in HDF grigio cenere sp.3 mm.

Vetro temperato satinato sp.4 mm laccato nei colori caldi e freddi.

Vetro temperato lucido sp.4 mm laccato nei colori caldi e freddi.

Aluminium frame Th.22 mm dust painted with matt finish matching with the glass and back coated with an HDF panel colour ash grey.

Hardened satin glass, lacquered in the following hot and cold colours.

Hardened glossy glass, lacquered in the following hot and cold colours.



telaio alluminio, vetro fumo  
aluminum frame, smoke glass



particolare retro anta grigio cenere  
detail of the back side of the door,  
ash grey colour

Neck

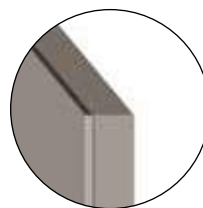

particolare anta squadrata  
squared edge door detail

Lux



particolare anta inclinata  
inclined edge door detail



SP. 22 MM TH. 22 MM

anta vetro satinato satin glass door

# OLTRE **N**eck **G55** **L**ux **G65**

## COLORI FREDDI SATINATI SATIN COLD COLOURS



## COLORI CALDI SATINATI SATIN HOT COLOURS

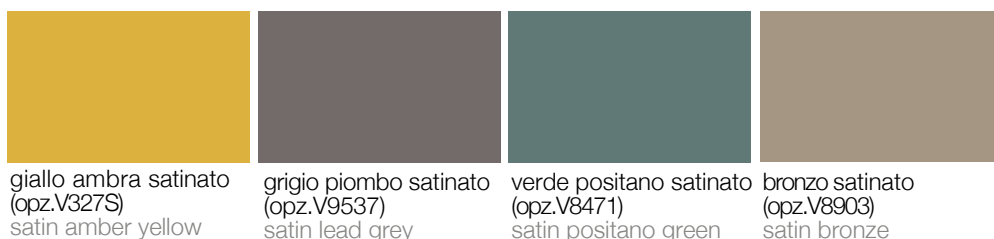

anta vetro lucido glossy glass doors

# OLTRE **N**eck **G56** **L**ux **G66**

## COLORI FREDDI LUCIDO GLOSSY COLD COLOURS



## COLORI CALDI LUCIDO GLOSSY HOT COLOURS



VETRO  
COLORATO  
COLOURED GLASS

## MANIGLIE HANDLES

# OLTRE **B**ridge

### DI SERIE STANDARD



Maniglia 574 finitura acciaio ossidato brown  
anta L 15 → passo 16 mm  
anta da L 30 a L 60 → passo 160 mm  
anta da L 90 a L 120 → passo 320 mm

Handle 574 brown oxidized steel finish  
door W 15 → centre-to-centre distance 16 mm  
door from W 30 to W 60 → centre-to-centre distance 160 mm  
door from W 90 to W 120 → centre-to-centre distance 320 mm



Maniglia 575 finitura ferro  
anta L 15 → passo 64 mm  
anta da L 30 a L 45 → passo 192 mm  
anta da L 60 a L 120 → passo 320 mm

Handle 575 iron finish  
door W 15 → centre-to-centre distance 64 mm  
door from W 30 to W 45 → centre-to-centre distance 192 mm  
door from W 60 to W 120 → centre-to-centre distance 320 mm



Maniglia 491 finitura inox satinato  
anta L 15 → passo 96 mm  
anta da L 30 a L 60 → passo 160 mm  
anta da L 90 a L 120 → passo 320 mm

Handle 491 stainless steel satin finish  
door W 15 → centre-to-centre distance 96 mm  
door from W 30 to W 60 → centre-to-centre distance 160 mm  
door from W 90 to W 120 → centre-to-centre distance 320 mm



Maniglia 477 finitura cromo  
anta L 15 → passo 64 mm  
anta da L 30 a L 45 → passo 160 mm  
anta da L 60 a L 120 → passo 320 mm

Handle 477 chrome finish  
door W 15 → centre-to-centre distance 64 mm  
door from W 30 to W 45 → centre-to-centre distance 160 mm  
door from W 60 to W 120 → centre-to-centre distance 320 mm

### A RICHIESTA ON REQUEST



Maniglia 590 finitura nero martellato  
anta L 15 → passo 96 mm  
anta da L 30 a L 120 → passo 192 mm

Handle 590 hammered black finish  
door W 15 → centre-to-centre distance 96 mm  
door from W 30 to W 120 → centre-to-centre distance 192 mm



Maniglia 576 finitura urban  
anta L 15 → passo 96 mm  
anta da L 30 a L 45 → passo 160 mm  
anta da L 60 a L 120 → passo 320 mm

Handle 576 urban finish  
door W 15 → centre-to-centre distance 96 mm  
door from W 30 to W 45 → centre-to-centre distance 160 mm  
door from W 60 to W 120 → centre-to-centre distance 320 mm



Maniglia 578D finitura old dark  
anta L 15 → passo 64 mm  
anta da L 30 a L 45 → passo 192 mm  
anta da L 60 a L 120 → passo 320 mm

Handle 578D old dark finish  
door W 15 → centre-to-centre distance 64 mm  
door from W 30 to W 45 → centre-to-centre distance 192 mm  
door from W 60 to W 120 → centre-to-centre distance 320 mm



Maniglia 551 finitura cromo  
anta L 15 → passo 64 mm  
anta da L 30 a L 45 → passo 160 mm  
anta da L 60 a L 120 → passo 320 mm

Handle 551 chrome finish  
door W 15 → centre-to-centre distance 64 mm  
door from W 30 to W 45 → centre-to-centre distance 160 mm  
door from W 60 to W 120 → centre-to-centre distance 320 mm



Maniglia 585 finitura acciaio ossidato semiopaco  
anta L 15 → passo 64 mm  
anta da L 30 a L 120 → passo 160 mm

Handle 585 half-matt oxidized steel finish  
door W 15 → centre-to-centre distance 64 mm  
door from W 30 to W 120 → centre-to-centre distance 160 mm



Maniglia 578G finitura old grey  
anta L 15 → passo 64 mm  
anta da L 30 a L 45 → passo 192 mm  
anta da L 60 a L 120 → passo 320 mm

Handle 578G old grey finish  
door W 15 → centre-to-centre distance 64 mm  
door from W 30 to W 45 → centre-to-centre distance 192 mm  
door from W 60 to W 120 → centre-to-centre distance 320 mm

### AD INCASSO RECESSED



Maniglia 581 finitura bronzo titanio  
anta L 15 → passo 64 mm  
anta da L 30 a L 120 → passo 128 mm

Handle 581 titanium bronze finish  
door W 15 → centre-to-centre distance 64 mm  
door from W 30 to W 120 → centre-to-centre distance 128 mm

**A RICHIESTA ON REQUEST**



Maniglia 59RA finitura anodizzato rame anticato  
anta L 15 → passo 32 mm  
anta L 30 a L 45 → passo 160 mm  
anta da L 60 a L 120 → passo 448 mm

Handle 59RA oxidized antique copper finish  
door W 15 → centre-to-centre distance 32 mm  
door W 30 to W 45 → centre-to-centre distance 160 mm  
door from W 60 to W 120 → centre-to-centre distance 448 mm



Maniglia 59BA finitura anodizzato bronzo anticato  
anta L 15 → passo 32 mm  
anta L 30 a L 45 → passo 160 mm  
anta da L 60 a L 120 → passo 448 mm

Handle 59BA oxidized antique bronze finish  
door W 15 → centre-to-centre distance 32 mm  
door W 30 to W 45 → centre-to-centre distance 160 mm  
door from W 60 to W 120 → centre-to-centre distance 448 mm



Maniglia 59BB finitura anodizzato titanio  
anta L 15 → passo 32 mm  
anta L 30 a L 45 → passo 160 mm  
anta da L 60 a L 120 → passo 448 mm

Handle 59BB oxidized titanium finish  
door W 15 → centre-to-centre distance 32 mm  
door W 30 to W 45 → centre-to-centre distance 160 mm  
door from W 60 to W 120 → centre-to-centre distance 448 mm



Maniglia 59F finitura anodizzato grafite  
anta L 15 → passo 32 mm  
anta L 30 a L 45 → passo 160 mm  
anta da L 60 a L 120 → passo 448 mm

Handle 59F oxidized graphite finish  
door W 15 → centre-to-centre distance 32 mm  
door W 30 to W 45 → centre-to-centre distance 160 mm  
door from W 60 to W 120 → centre-to-centre distance 448 mm



Maniglia 59K finitura anodizzato acciaio  
anta L 15 → passo 32 mm  
anta L 30 a L 45 → passo 160 mm  
anta da L 60 a L 120 → passo 448 mm

Handle 59K oxidized stainless steel finish  
door W 15 → centre-to-centre distance 32 mm  
door W 30 to W 45 → centre-to-centre distance 160 mm  
door from W 60 to W 120 → centre-to-centre distance 448 mm



Maniglia 59N finitura anodizzato nero  
anta L 15 → passo 32 mm  
anta L 30 a L 45 → passo 160 mm  
anta da L 60 a L 120 → passo 448 mm

Handle 59N oxidized black finish  
door W 15 → centre-to-centre distance 32 mm  
door W 30 to W 45 → centre-to-centre distance 160 mm  
door from W 60 to W 120 → centre-to-centre distance 448 mm



Maniglia 57RA finitura rame anticato  
anta L 15 → passo 12 mm  
anta L 30 a L 45 → passo 160 mm  
anta da L 60 a L 120 → passo 320 mm

Handle 57RA antique copper finish  
door W 15 → centre-to-centre distance 12 mm  
door W 30 to W 45 → centre-to-centre distance 160 mm  
door from W 60 to W 120 → centre-to-centre distance 320 mm



Maniglia 57BA finitura bronzo anticato  
anta L 15 → passo 12 mm  
anta L 30 a L 45 → passo 160 mm  
anta da L 60 a L 120 → passo 320 mm

Handle 57BA antique bronze finish  
door W 15 → centre-to-centre distance 12 mm  
door W 30 to W 45 → centre-to-centre distance 160 mm  
door from W 60 to W 120 → centre-to-centre distance 320 mm



Maniglia 57BB finitura bronzo brunito  
anta L 15 → passo 12 mm  
anta L 30 a L 45 → passo 160 mm  
anta da L 60 a L 120 → passo 320 mm

Handle 57BB burnished bronze finish  
door W 15 → centre-to-centre distance 12 mm  
door W 30 to W 45 → centre-to-centre distance 160 mm  
door from W 60 to W 120 → centre-to-centre distance 320 mm



Maniglia 57F finitura grafite  
anta L 15 → passo 12 mm  
anta L 30 a L 45 → passo 160 mm  
anta da L 60 a L 120 → passo 320 mm

Handle 57F graphite finish  
door W 15 → centre-to-centre distance 12 mm  
door W 30 to W 45 → centre-to-centre distance 160 mm  
door from W 60 to W 120 → centre-to-centre distance 320 mm



Maniglia 57K finitura nichel  
anta L 15 → passo 12 mm  
anta L 30 a L 45 → passo 160 mm  
anta da L 60 a L 120 → passo 320 mm

Handle 57K nickel finish  
door W 15 → centre-to-centre distance 12 mm  
door W 30 to W 45 → centre-to-centre distance 160 mm  
door from W 60 to W 120 → centre-to-centre distance 320 mm

**MANIGLIA ORIZZONTALE HANDLE HORIZONTAL**

# OLTRE **B**ridge



Maniglia M42 finitura nichel satinata  
 passo in funzione dell'anta  
 Handle M42 nickel satin finish  
 centre-to-centre distance varies according to the door

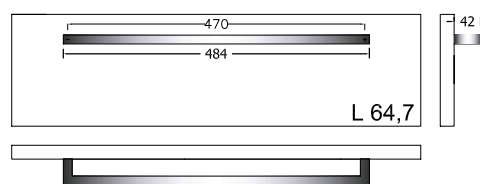
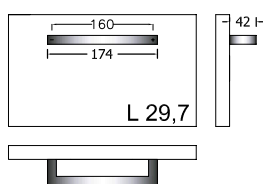
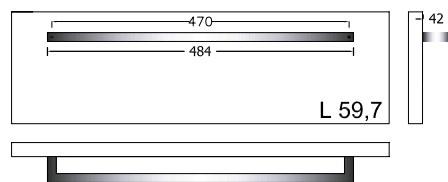
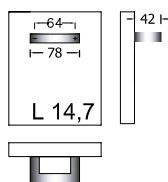

**ANGOLO PENSILE A LIBRO**  
 corner wall unit folding

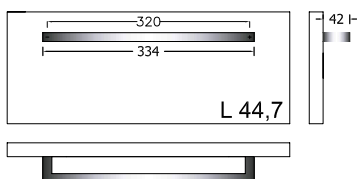
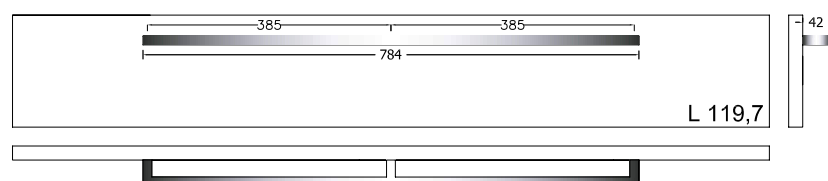
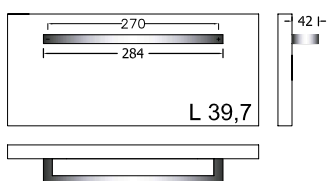
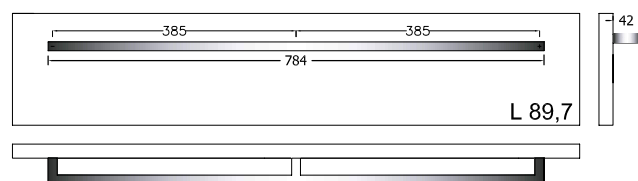
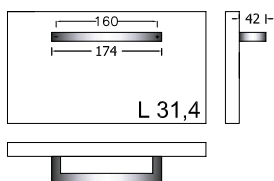



**MANIGLIA ORIZZONTALE** HANDLE HORIZONTAL

# OLTRE **B**ridge



Maniglia M41 finitura ferro grezzo  
 passo in funzione dell'anta  
 Handle M41 unrefined iron finish  
 centre-to-centre distance varies according to the door

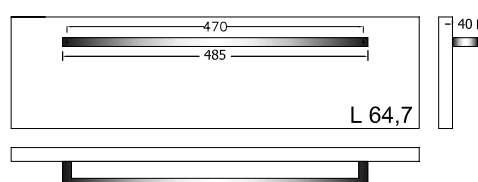
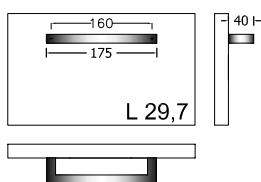
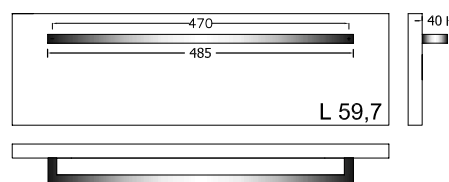
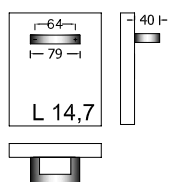

**ANGOLO PENSILE A LIBRO**  
 corner wall unit folding

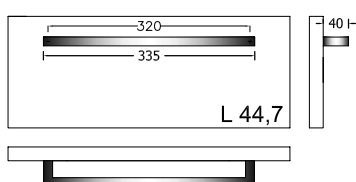
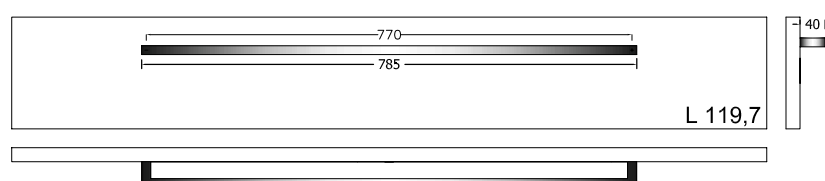
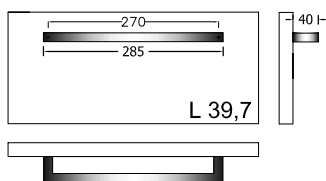
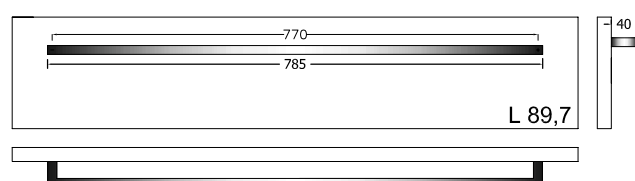
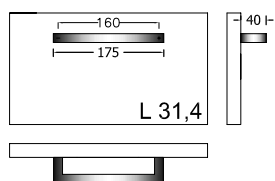

# MANIGLIA VERTICALE HANDLE VERTICAL

# OLTRE **B**ridge



Maniglia M42V finitura nichel satinata  
 passo in funzione dell'anta  
 Handle M42V nickel satin finish  
 centre-to-centre distance varies according to the door

**N.B.:** la maniglia verticale non è disponibile per tutti gli elementi. Non inseribile su pensili, basi con cassetti e cestone  
 Note: The vertical handle is not compatible with all the elements. Is not possible to insert it on the wall units and base units with drawers and deep drawers.

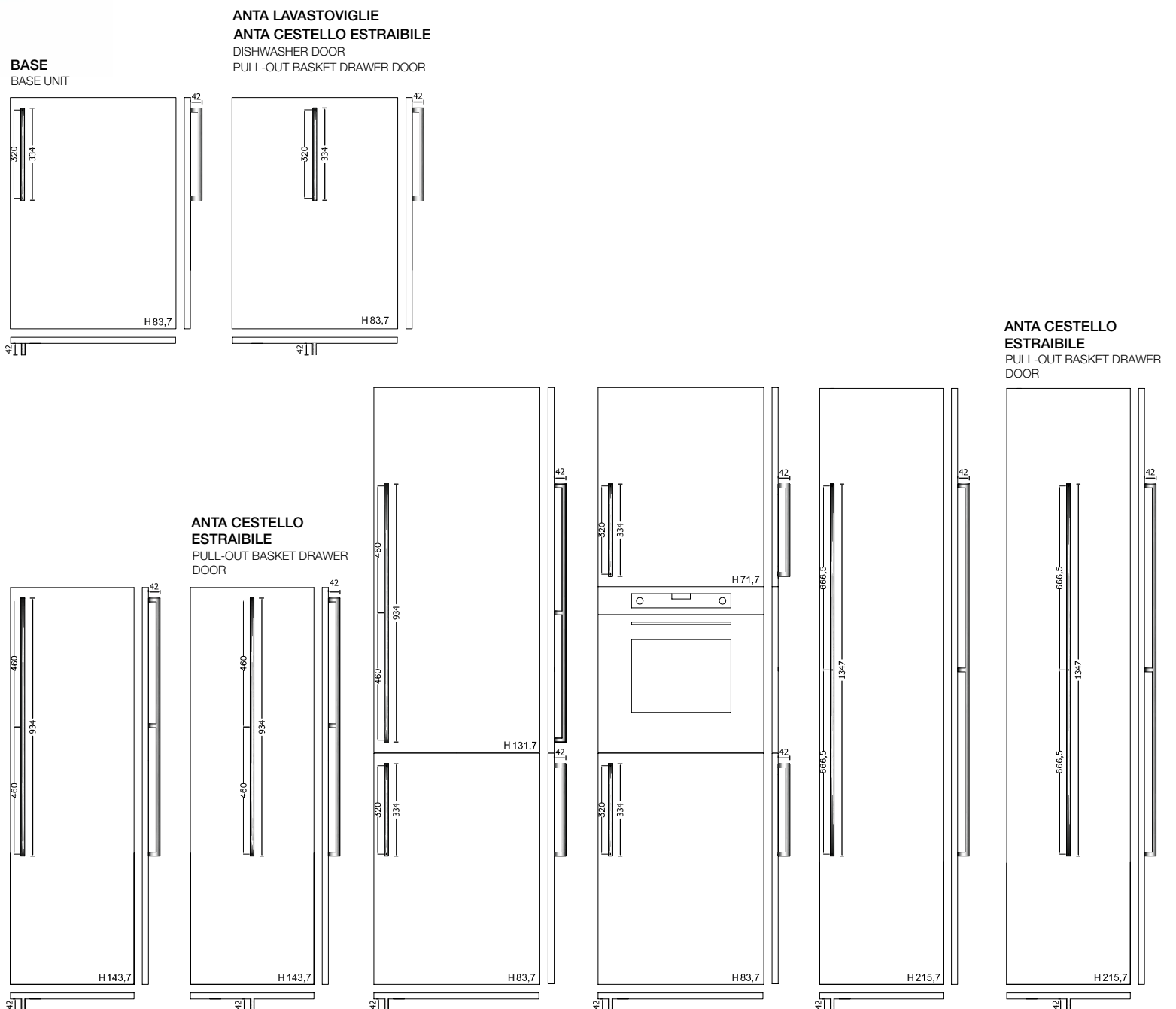

# MANIGLIA VERTICALE HANDLE VERTICAL

# OLTRE **B**ridge



Maniglia M41V finitura ferro grezzo  
 passo in funzione dell'anta  
 Handle M41V unrefined iron finish  
 centre-to-centre distance varies according to the door

**N.B.:** la maniglia verticale non è disponibile per tutti gli elementi. Non inseribile su pensili, basi con cassetti e cestone  
 Note: The vertical handle is not compatible with all the elements. Is not possible to insert it on the wall units and base units with drawers and deep drawers.

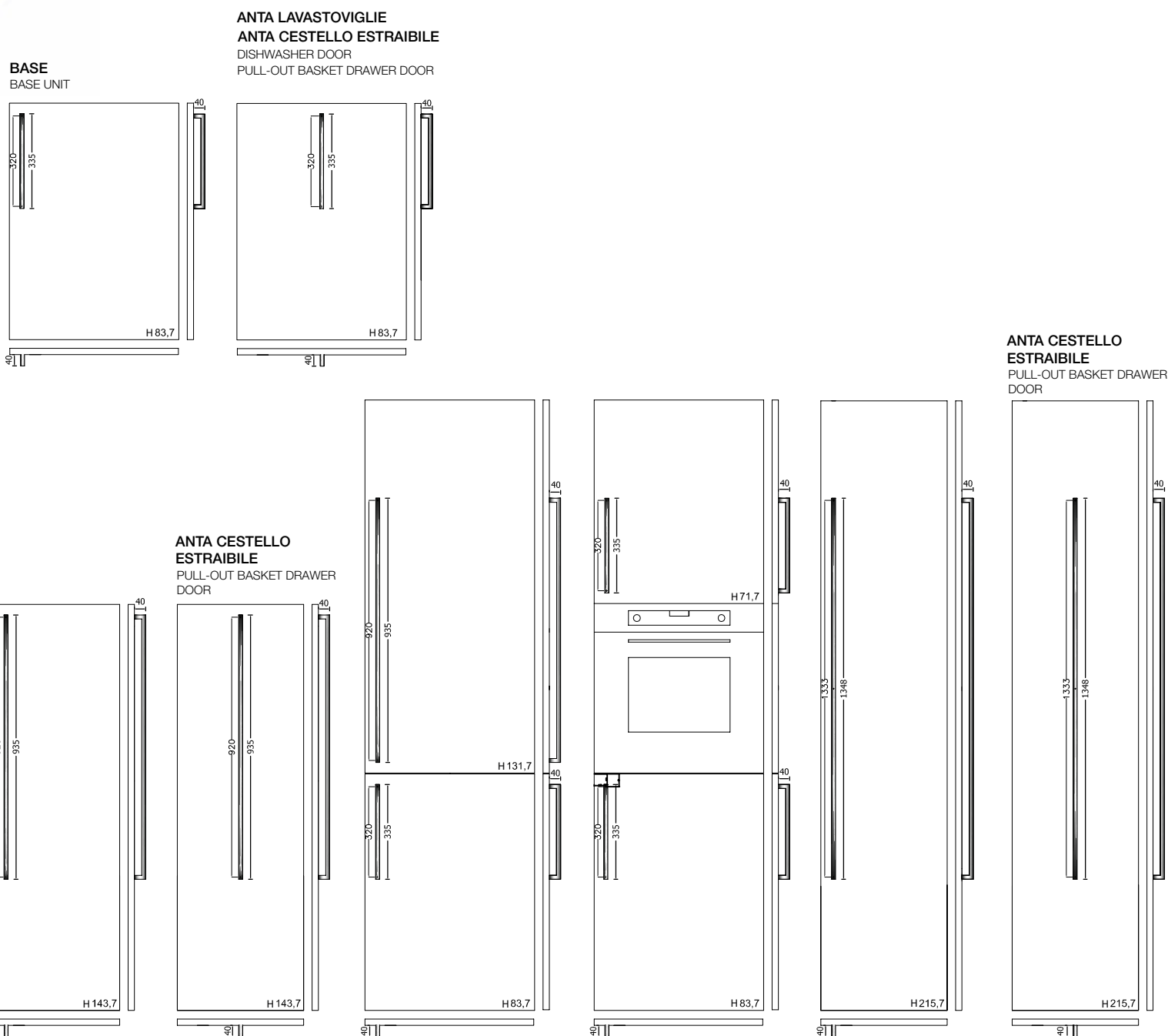

## MANIGLIA APPLICATA IN TESTA TOP-MOUNTED HANDLE

---

# OLTRE **B**ridge

N.B.: In presenza di questa maniglia non si possono tassativamente realizzare fuori misura in larghezza.  
Note: Custom-sized length elements cannot be realized using this handle.



Maniglia H51 finitura urban . vedi schema tecnico

Handle H51 urban finish size see technical diagram



Maniglia H52 finitura titanio vedi schema tecnico

Handle H52 titanium finish size see technical diagram



# SCHEMA MANIGLIA

## HANDLE DIAGRAM

### MANIGLIA APPLICATA IN TESTA TOP-MOUNTED HANDLE

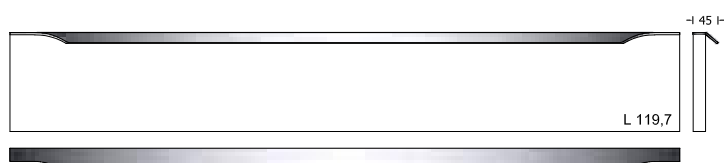
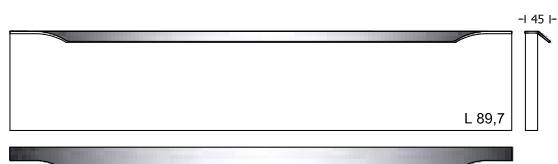
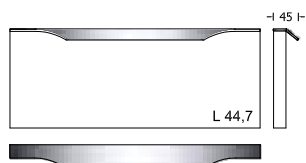
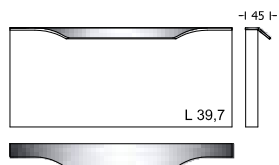
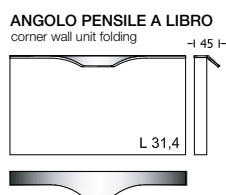
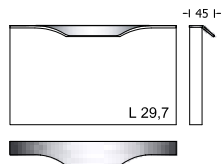
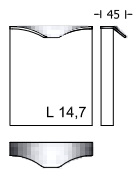

### MANIGLIA FRONTALE PER ANTA COLONNA FRONT DOOR HANDLE FOR COLUMN

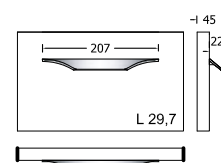
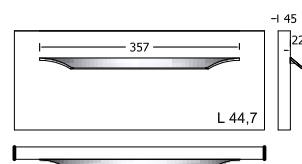
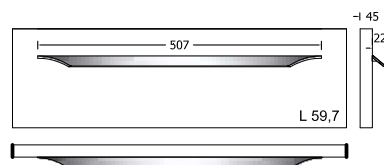
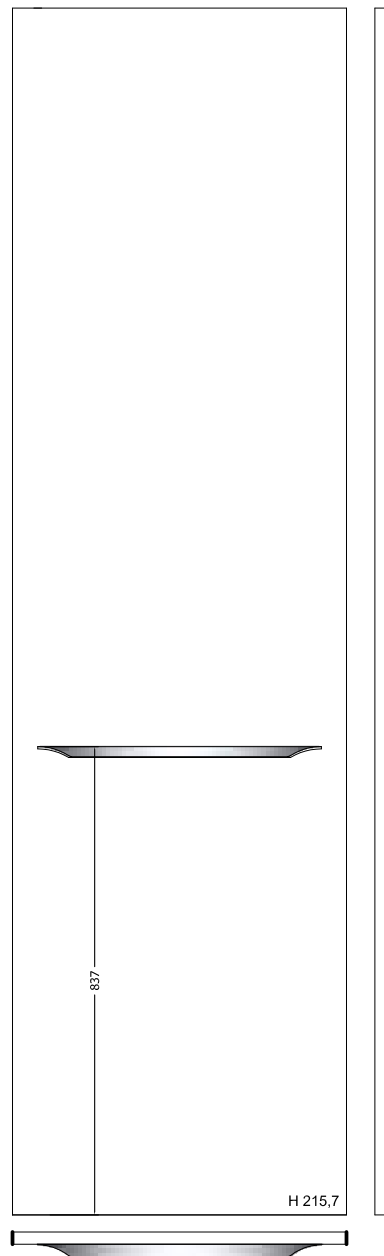

# MANIGLIA FUSION FUSION HANDLE

# OLTRE **B**ridge



Maniglia fusion FU11  
finitura nero opaco  
passo in funzione dell'anta  
vedi schema tecnico  
Handle fusion FU11 matt black finish  
centre-to-centre distance varies according  
to the door  
size see technical diagram



particolare maniglia fusion nero opaco  
detail black fusion matt black handle



Maniglia fusion FU12  
finitura titanio  
passo in funzione dell'anta  
vedi schema tecnico  
Handle fusion FU12 titanium finish  
centre-to-centre distance varies according  
to the door  
size see technical diagram



particolare maniglia fusion titanio  
detail titanium fusion handle



# SCHEMA MANIGLIA

## HANDLE DIAGRAM

**N.B.: non inseribile su pensili, basi cassetti e cestoni**  
Note.: not inserted on wall units, base units drawers and deep drawers

# OLTRE **B**ridge

### BASI H 90

BASE UNITS H 90

BASE  
BASE UNIT

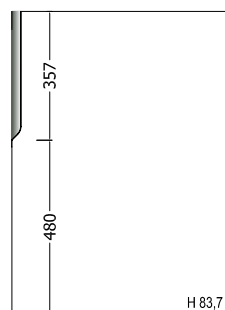

ANTA LAVASTOVIGLIE  
CON SERVO-DRIVE FLEX  
DISHWASHER DOOR  
WITH SERVO-DRIVE FLEX

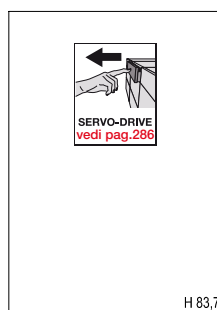

### COLONNE H 114-150

COLUMNS H 114-150

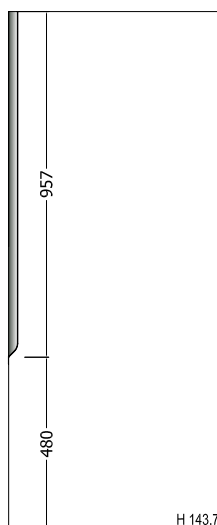
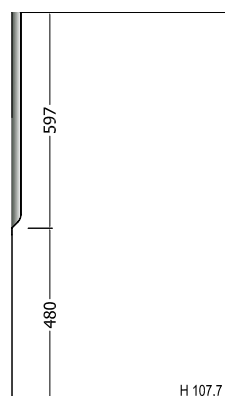

### COLONNE H 222

COLUMNS H 222

ANTA COLONNA ATTREZZATA  
COLUMN EQUIPPED DOOR

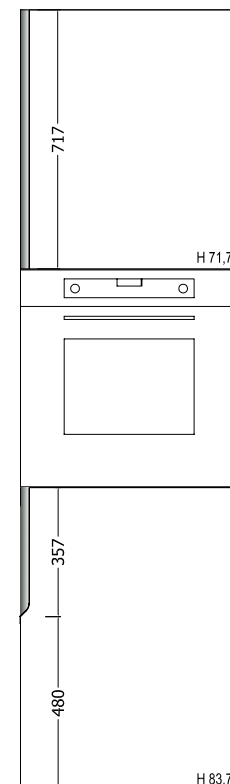
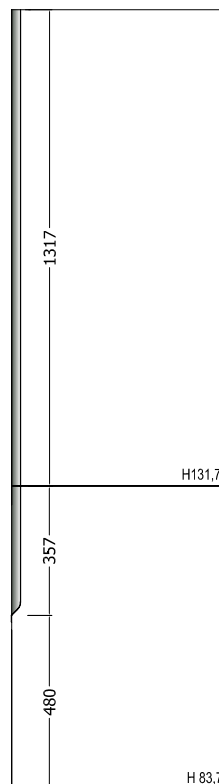
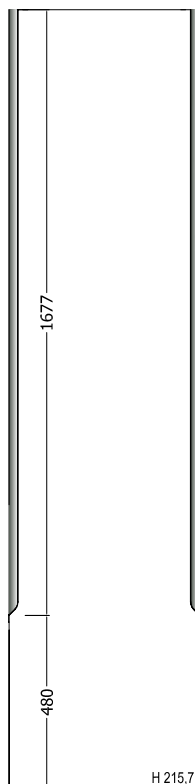
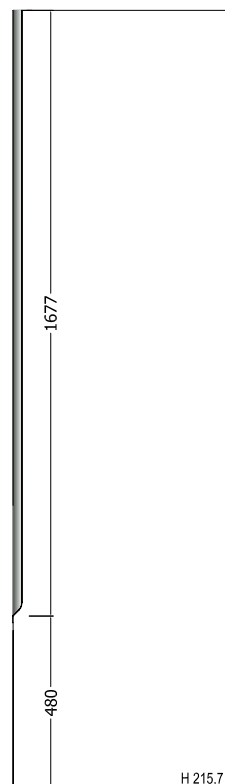





LA COLLEZIONE HI-LINE  
RIVOLUZIONA IL CONCETTO DEI  
MATERIALI E DEI COMPLEMENTI CHE  
COSTITUISCONO UNA CUCINA.  
ELEMENTI IN ALLUMINIO, ANTE AD  
EFFETTO METALLO, ACCESSORI DAL  
DESIGN UNICO, APPOSITAMENTE CREATI  
PER ESALTARE IL PROGRAMMA OLTRE.

THE HI-LINE COLLECTION CHANGES THE CONCEPT  
OF MATERIALS AND ACCESSORIES THAT MAKES UP A KITCHEN.  
ALUMINIUM ELEMENTS, DOORS FINISHES WITH METAL  
EFFECT AND ACCESSORIES WITH A UNIQUE DESIGN, HAVE BEEN  
CREATED TO ENHANCE THE OLTRE PROGRAM.

# OLTRE

## Hi-line

COMPLEMENTI  
DI ALTO LIVELLO  
HIGH LEVEL ACCESSORIES



**SP. 22 MM TH. 22 MM**

OLTRE

## CARATTERISTICHE TECNICHE

### ANTE E FRONTALI CASSETTI

anta sp.22 mm composta da un telaio di alluminio estruso dove viene alloggiata sul fronte una lamina imbutita e sul retro un pannello di tamponamento entrambi in alluminio.  
Tra le due lamiere nell'intercapedine viene inserito un materiale con proprietà fonoassorbenti e termoisolanti capaci di rendere l'anta consistente pur mantenendo la sua leggerezza.  
L'anta Hi-line forte del proprio design è interamente riciclabile.  
La finitura dell'anta viene realizzata con un unico bagno anodico nei colori: nero (opz.AL11) e titanio (opz.AL12)

### MANIGLIE

AL11 finitura nera passo mm 192  
AL12 finitura titanio passo mm 192

N.B.: disponibilità apertura senza maniglia

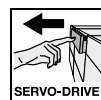
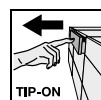
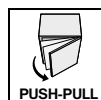

### STRUTTURE

**ANTA: nero**  
nobilitato lavagna (opz.9620) schiena e ripiano lavagna (opz.9620)  
**ANTA: titanio**  
nobilitato fango (opz.8860) schiena e ripiano fango (opz.8860)



### MENSOLE

altezza cm 3,8 in laminato come strutture: lavagna (opz.9620), fango (opz.8860)

### ZOCOLI

zoccolo H 6 in alluminio titanio ossidato (opz.414)  
zoccolo H 6 in alluminio verniciato a polvere finitura opaca nel colore: nero (opz.7892)

## TECHNICAL FEATURES

### DOORS AND DRAWER FRONTS

Th. mm 22 door composed by an extruded aluminum frame. In the front side of the door is placed an aluminum deep-drawn foil and on the back side an aluminum filler panel.  
In the gap between the two sheets it is inserted a material with sound-absorbing and heat-insulating properties, that can make the door more consistent, without modify its lightweight.  
The Hi-line door is completely recyclable.  
The door finish is realized with a single anodic bath in the colors: black (opt.AL11) and titanium (opt.AL12)

### HANDLES

AL11 black finish centre-to-centre distance 192 mm  
AL12 titanium finish centre-to-centre distance 192 mm

Note: no handle opening available

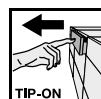
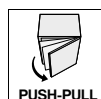

### STRUCTURES

**DOOR: black**  
melamine-coated slate grey (opt.9620), slate grey back panel and shelf (opt.9620)  
**DOOR: titanium**  
melamine-coated mud (opt.8860), mud back panel and shelf (opt.8860)

### SHELVES

height 3.8 cm, in laminate to match structure: slate grey (opt.9620), mud (opt.8860)

### PLINTHS

plinth H 6 cm in aluminium with oxidised titanium (opt.414)  
plinth H 6 cm in aluminium with matt powder coating in the following colours: black (opt.7892),



# OLTRE

**SP. 22 MM TH. 22 MM**

anta Hi-line con maniglia  
Hi-line door with handle



anta nera (opz.AL11)  
black door (opt.AL11)



anta titanio (opz.AL12)  
titanium door (opt.AL12)



particolare maniglia  
detail frame with  
handle

**SP. 22 MM TH. 22 MM**

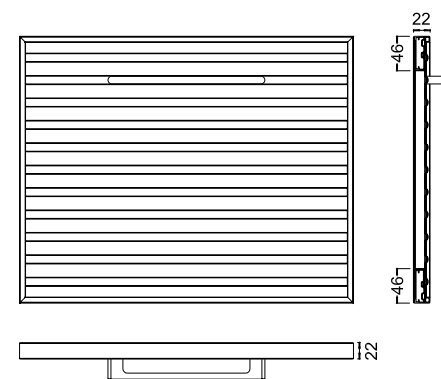

anta Hi-line senza maniglia  
Hi-line door without handle



anta nera (opz.AL11)  
black door (opt.AL11)



anta titanio (opz.AL12)  
titanium door (opt.AL12)

**SP. 22 MM TH. 22 MM**

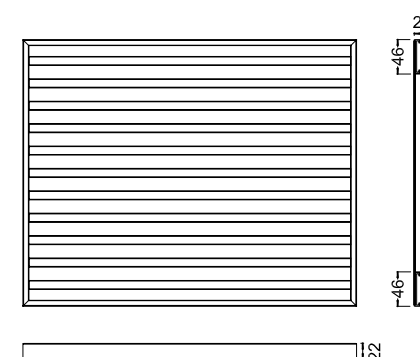

## strutture carcasses

**NEW**

**NEW**



bianco (opz.001)  
schiena e ripiano bianco  
(opz.001)  
white (opt.001)  
white back panel and shelf  
(opt.001)



perla d'oriente (opz.940)  
schiena e ripiano bianco  
(opz.001)  
oriental pearl (opt.940)  
white back panel and shelf  
(opt.001)



conchiglia (opz.8910)  
schiena e ripiano conchiglia  
(opz.8910)  
shell (opt.8910)  
shell back panel and shelf  
(opt.8910)



argilla (opz.9690)  
schiena e ripiano argilla  
(opz.9690)  
clay (opt.9690)  
clay back panel and shelf  
(opt.9690)



lavagna (opz.9620)  
schiena e ripiano lavagna  
(opz.9620)  
slate grey (opt.9620)  
slate grey back panel  
and shelf (opt.9620)



fango (opz.8860)  
schiena e ripiano fango  
(opz.8860)  
mud (opt.8860)  
mud back panel and  
shelf (opt.8860)



visone (opz.948M)  
schiena e ripiano visone  
(opz.948M)  
mink (opt.948M)  
mink back panel and shelf  
(opt.948M)



### LUBE ECOLOGIC

IL GRUPPO LUBE HA SCELTO DI UTILIZZARE PER I COMPONENTI COSTITUENTI LE STRUTTURE DELLE CUCINE SOLO MATERIALE A BASSISSIMA EMISSIONE DI FORMALDEIDE: CONFORMI ALLO STANDARD F\*\*\*\* SECONDO LA NORMA JIS, CERTIFICATO DAL MINISTERO GIAPPONESE, IL PIU' SEVERO IN MERITO ALLE NORMATIVE DI SALVAGUARDIA AMBIENTALE.

LUBE GROUP HAS CHOSEN TO EXCLUSIVELY USE MATERIALS WITH VERY LOW FORMALDEHYDE EMISSIONS FOR THE COMPONENTS MAKING UP THE KITCHEN CARCASSES: THESE ELEMENTS COMPLY WITH THE F4 STAR STANDARD ACCORDING TO JIS, CERTIFIED BY THE JAPANESE GOVERNMENT - THE MOST STRINGENT WHEN IT COMES TO ENVIRONMENTAL PROTECTION.

## mensole in laminato P 31-61 come strutture same colours as carcasses laminated shelves D 31-61



bianco (opz.001)  
white (opt.001)



perla d'oriente (opz.940)  
oriental pearl (opt.940)



fango (opz.8860)  
mud (opt.8860)



visone (opz.948M)  
mink (opt.948M)



lavagna (opz.9620)  
slate grey (opt.9620)

**NEW**

**NEW**



argilla (opz.9690)  
clay (opt.9690)



conchiglia (opz.8910)  
shell (opt.8910)

## mensole impialacciate veneered shelves



impialacciata come anta  
N.B.: per le finiture vedi pagina 184  
veneered same finish as door  
Note: for the finishes see page 184

## mensole fenix fenix shelves



fenix come anta  
N.B.: per le finiture vedi pagina 188  
fenix as door  
Note: for the finishes see page 188

## mensole laccate lacquered shelves



laccate opache e lucide come anta  
N.B.: per le finiture vedi pagine 198-199  
matt and glossy lacquered as door  
Note: for the finishes see pages 198-199

## mensole laccate vintage vintage lacquered shelves



laccate vintage come anta  
N.B.: per le finiture vedi pagina 202  
vintage lacquered as door  
Note: for the finishes see page 202

## zoccoli in alluminio H 6 aluminium plinth H 6

di serie  
standard



alluminio finitura titanio  
ossidato (opz.414)  
aluminium titanium  
oxidized finish (opt.414)

**N.B.: ABBINAMENTO CONSIGLIATO  
CON L'ANTA BRONZO BRUNITO  
NOTE: BEST MATCHING WITH THE  
BURNISHED BRONZE DOOR**

## zoccoli in alluminio H 6 aluminium plinth H 6

a richiesta  
on request



alluminio finitura urban  
ossidato (opz.NU)  
aluminium urban  
oxidized finish (opt.NU)



alluminio  
finitura brill (opz.412)  
aluminium  
brill finish (opt.412)

**NEW**



alluminio finitura rame  
anticato (opz.422)  
aluminium antique  
copper finish  
(opt.422)

**NEW**



alluminio finitura  
grafite (opz.421)  
aluminium graphite  
finish (opt.421)

**NEW**



alluminio finitura nichel  
(opz.420)  
aluminium nickel  
finish (opt.420)

**NEW**



alluminio finitura  
bronzo anticato  
(opz.423)  
aluminium antique  
bronze finish (opt.423)

## zoccoli in alluminio H 6 verniciati a polvere finitura opaca aluminum plinth height H 6 powder coated matt finish



alluminio finitura nero  
(opz.7892)  
aluminium  
black finish (opt.7892)



alluminio finitura fumo  
(opz.9531)  
aluminium  
smoke finish  
(opt.9531)



alluminio finitura  
bianco caldo (opz.7401)  
aluminium warm white  
finish (opt.7401)



alluminio finitura  
bianco assoluto (opz.740S)  
aluminium absolute  
white finish (opt.740S)



alluminio finitura  
verde positano  
(opz.8471)  
aluminium positano  
green finish (opt.8471)



alluminio finitura  
acquamarina  
(opz.8323)  
aluminium  
aquamarine finish  
(opt.8323)



alluminio finitura  
castoro (opz.8907)  
aluminium beaver  
finish (opt.8907)



alluminio finitura rosso  
toscano (opz.8157)  
aluminium tuscan red  
finish (opt.8157)



alluminio finitura grigio  
bromo (opz.9533)  
aluminium bromine  
grey finish (opt.9533)



alluminio finitura  
silver dark (opz.9507)  
aluminium dark silver  
finish (opt.9507)



alluminio finitura  
argilla (opz.9503)  
aluminium clay  
finish (opt.9503)



alluminio finitura  
conchiglia (opz.7403)  
aluminium shell  
finish (opt.7403)



alluminio finitura  
ghisa (opz.9509)  
aluminium cast iron  
finish (opt.9509)



alluminio bistro  
(opz.9535)  
aluminium bistro  
finish (opt.9535)



alluminio finitura  
grigio selce (opz.SE)  
aluminium flint grey  
finish (opt.SE)

**MODULARITÀ E COMPONIBILITÀ MODULARITY AND FITTING SOLUTIONS**

- ESCLUSO 65 EXCLUDING 65
- ESCLUSO 45 EXCLUDING 45
- ESCLUSO 120 EXCLUDING 120
- ★ SOLO 90 ONLY 90

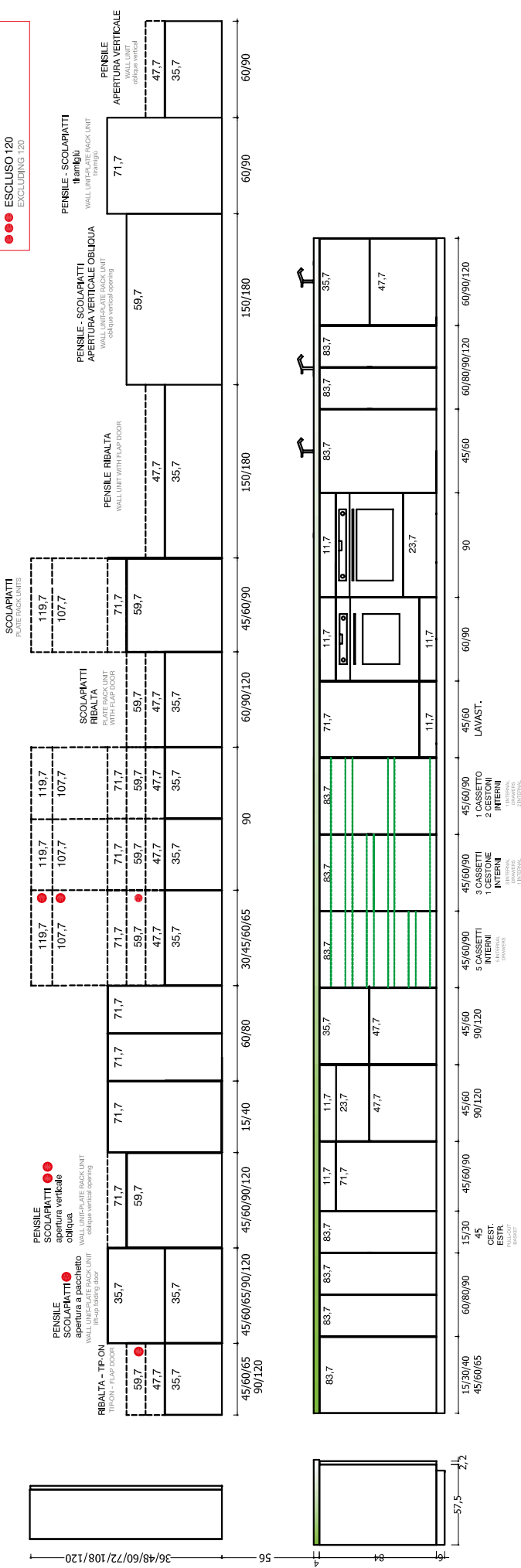

**BASI H 78**  
BASE UNITS H 78

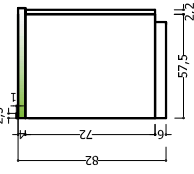

**BASI ROOMS**  
HANGING BASE UNITS

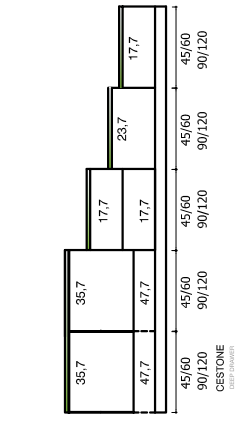
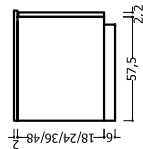

**COLONNE H 114 - 150**  
COLUMNS H 114 - 150

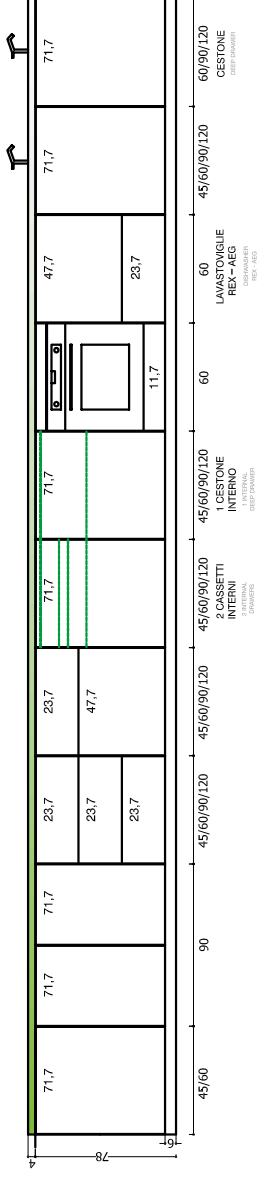
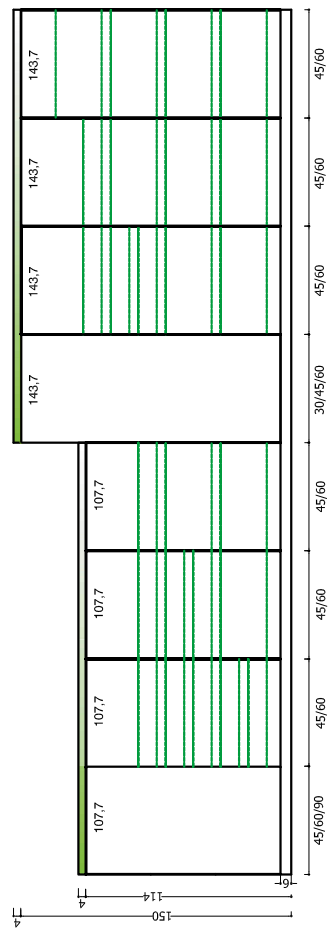
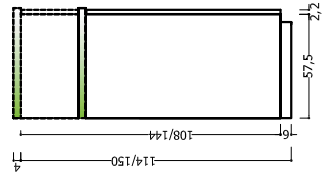

**BASI SOSEPPE**  
HANGING BASE UNITS

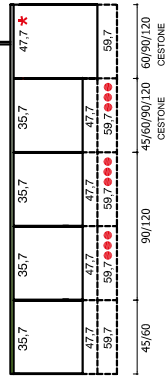
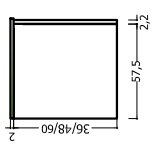

## MODULARITÀ E COMPONIBILITÀ MODULARITY AND FITTING SOLUTIONS

COLONNE  
COLUMNS

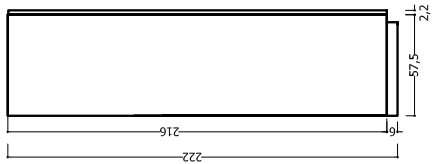

COLONNE FRIGO  
FRIDGE COLUMNS

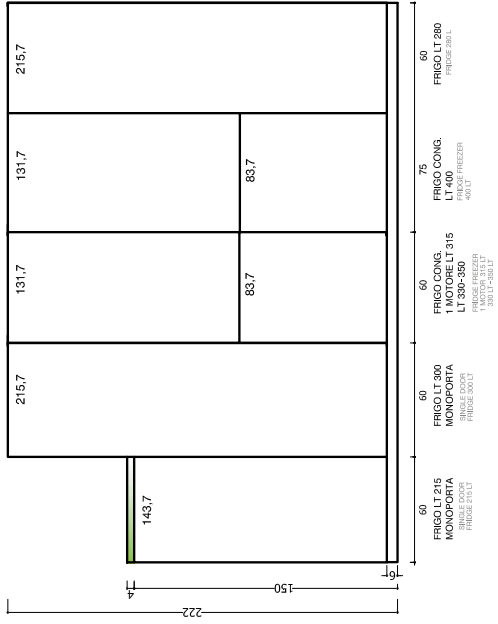
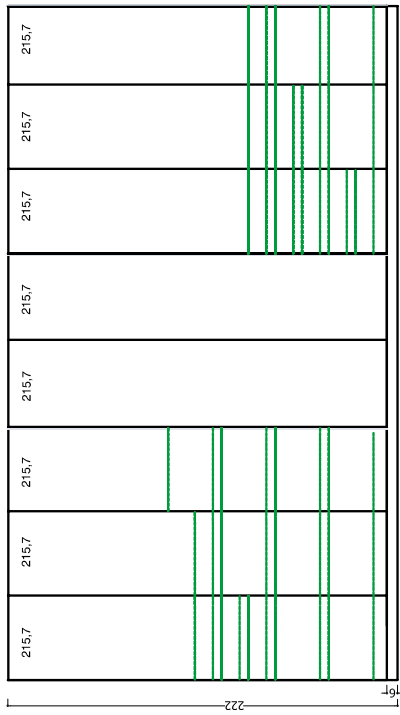
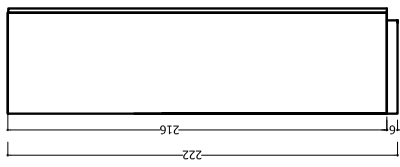

COLONNE FORNO  
OVEN COLUMNS

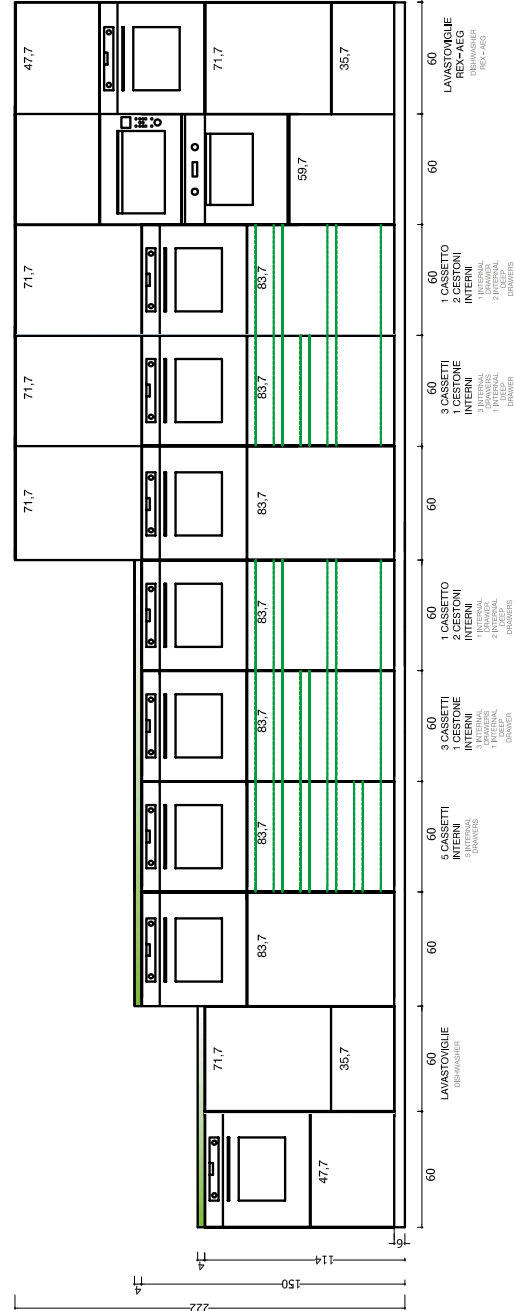
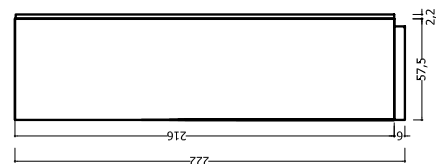

## ELEMENTI A GIORNO IN ALLUMINIO “AIR” HI-LINE

ALUMINIUM OPEN UNITS “AIR” HI-LINE

Gli elementi a giorno “AIR” sono realizzati con profilo da mm 20x20 e schienale in alluminio con ripiani in vetro bronzo 4 mm. temperato.

“AIR” open units are realized with a mm 20x20 profile, aluminium back panel and tempered bronze glass th 4 mm.



### FINITURE FINISHES



nero (opz.AL11)  
black (opt.AL11)



titanio (opz.AL12)  
titanium (opt.AL12)



# CONTENITORI "AIR"

"AIR" CONTAINER SHELVES

La linea "AIR" può essere personalizzata con dei contenitori impiallacciati e fenix realizzati in folding (vedi pag.317)

The "AIR" line can be customized with several container shelves made with folding process, in veneered or fenix finishes (see page 317)



ELEMENTI A GIORNO  
OPEN UNITS

## FINITURE IMPIALLACCiate

VENEERED FINISHES



rovere bianco invecchiato  
(opz.5380)  
white aged oak (opt.5380)

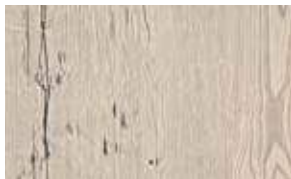

rovere juta invecchiato  
(opz.5381)  
jute aged oak (opt.5381)



rovere corteccia invecchiato  
(opz.5382)  
bark aged oak (opt.5382)



rovere mielato invecchiato  
(opz.5383)  
honey aged oak (opt.5383)



rovere antracite invecchiato  
(opz.5384)  
anthracite aged oak  
(opt.5384)



rovere argilla invecchiato  
(opz.5385)  
clay aged oak (opt.5385)



rovere moro invecchiato  
(opz.5386)  
dark aged oak (opt.5386)



rovere grigio terra (opz.5389)  
grey earth oak (opt.5389)



rovere naturale invecchiato  
parquettato (opz.5387)  
parquet-effect natural  
aged oak (opt.5387)



rovere madera termocotto  
(opz.5388)  
heat treated mader oak  
(opt.5388)

## FINITURE FENIX

FENIX FINISHES



bianco caldo (opz.7446)  
warm white (opt.7446)



castoro (opz.8864)  
beaver (opt.8864)

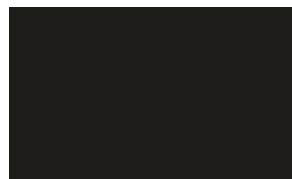

nero (opz.7861)  
black (opt.7861)



grigio bromo (opz.9628)  
bromine grey (opt.9628)



fumo (opz.9629)  
smoke (opt.9629)

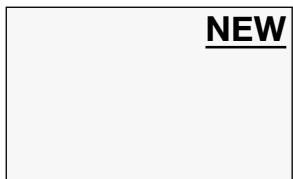

bianco dover (opz.7449)  
dover white (opt.7449)



cacao orinoco (opz.8865)  
cocoa orinoco (opt.8865)

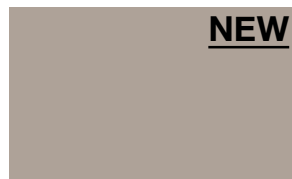

beige arizona (opz.7705)  
arizona beige (opt.7705)

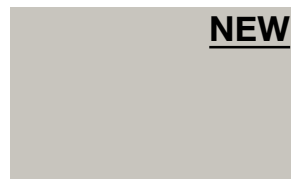

grigio efeso (opz.9630)  
ephesus grey (opt.9630)



blu fes (opz.8301)  
blue fes (opt.8301)

# ELEMENTI A GIORNO IN LAMIERA VERNICIATI A POLVERE SP.2 MM

POWDER PAINTED METAL SHEET OPEN UNITS TH.2 MM



## colori freddi opachi soft soft matt cold colours

bianco assoluto (opz.740S) absolute white	grigio bromo (opz.9533) bromine grey	grigio traffico (opz.9511) traffic grey	argilla (opz.9503) clay	silver dark (opz.9507) dark silver
---	--	---	-------------------------------	--

## colori caldi opachi soft soft matt hot colours

bianco caldo (opz.7401) warm white	grigio kenya (opz.9501) kenya grey	castoro (opz.8907) beaver	fumo (opz.9531) smoke	bistro (opz.9535) bistro	ghisa (opz.9509) cast iron
conchiglia (opz.7403) shell	lino (opz.9513) linen	creta (opz.9515) clay	mandorla (opz.W820) almond	visone (opz.9463) mink	verde positano (opz.8471) positano green
rosso toscano (opz.8157) tuscan red	grigio selce (opz.95SE) flint grey	acquamarina (opz.8323) aquamarine			

# ELEMENTI A GIORNO SP. 14 MM

OPEN ELEMENTS TH.14 MM



## COLORI IMPIALLACCIATI VENEERED COLOURS



## COLORI LACCATI OPACHI MATT LACQUERED COLOURS

# MOBILE DI COMPLEMENTO

ACCESSORY FURNITURE



## COLORI LACCATI VINTAGE EFFETTO METALLO

LACQUERED VINTAGE COLOURS METAL EFFECT

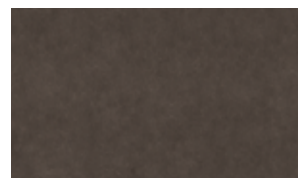

peltro (opz.9549)  
pewter (opt.9549)



ferro (opz.9506)  
iron (opt.9506)



urban (opz.7894)  
urban (opt.7894)

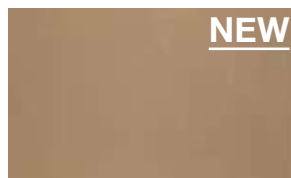

**NEW**

bronzo antico (opz.8909)  
antique bronze (opt.8909)



**NEW**

rame antico (opz.8159)  
antique copper (opt.8159)



**NEW**

nichel (opz.9505)  
nickel (opt.9505)

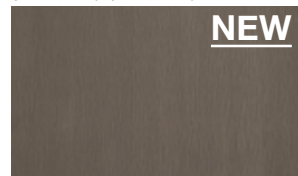

**NEW**

bronzo brunito (opz.8903)  
burnished bronze (opt.8903)

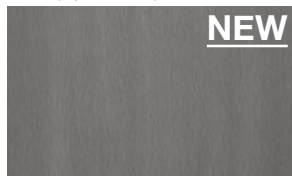

**NEW**

grafite (opz.9508)  
graphite (opt.9508)

## COLORI IMPIALLACCIATI DISPONIBILI SOLO PER BASI

VENEERED COLOURS AVAILABLE ONLY FOR BASE UNITS



rovere bianco invecchiato (opz.5380)  
white aged oak (opt.5380)



rovere juta invecchiato (opz.5381)  
jute aged oak (opt.5381)



rovere corteccia invecchiato (opz.5382)  
bark aged oak (opt.5382)



rovere mielato invecchiato (opz.5383)  
honey aged oak (opt.5383)



rovere antracite invecchiato (opz.5384)  
anthracite aged oak (opt.5384)



rovere argilla invecchiato (opz.5385)  
clay aged oak (opt.5385)



rovere moro invecchiato (opz.5386)  
dark aged oak (opt.5386)



rovere grigio terra (opz.5389)  
grey earth oak (opt.5389)



rovere naturale invecchiato parquetto (opz.5387)  
parquet-effect natural aged oak (opt.5387)

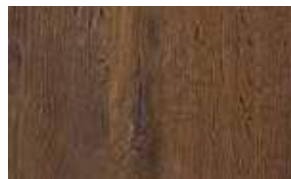

rovere madera termocotto (opz.5388)  
heat treated madera oak (opt.5388)

# MOBILE DI COMPLEMENTO L 107

ACCESSORY FURNITURE W 107

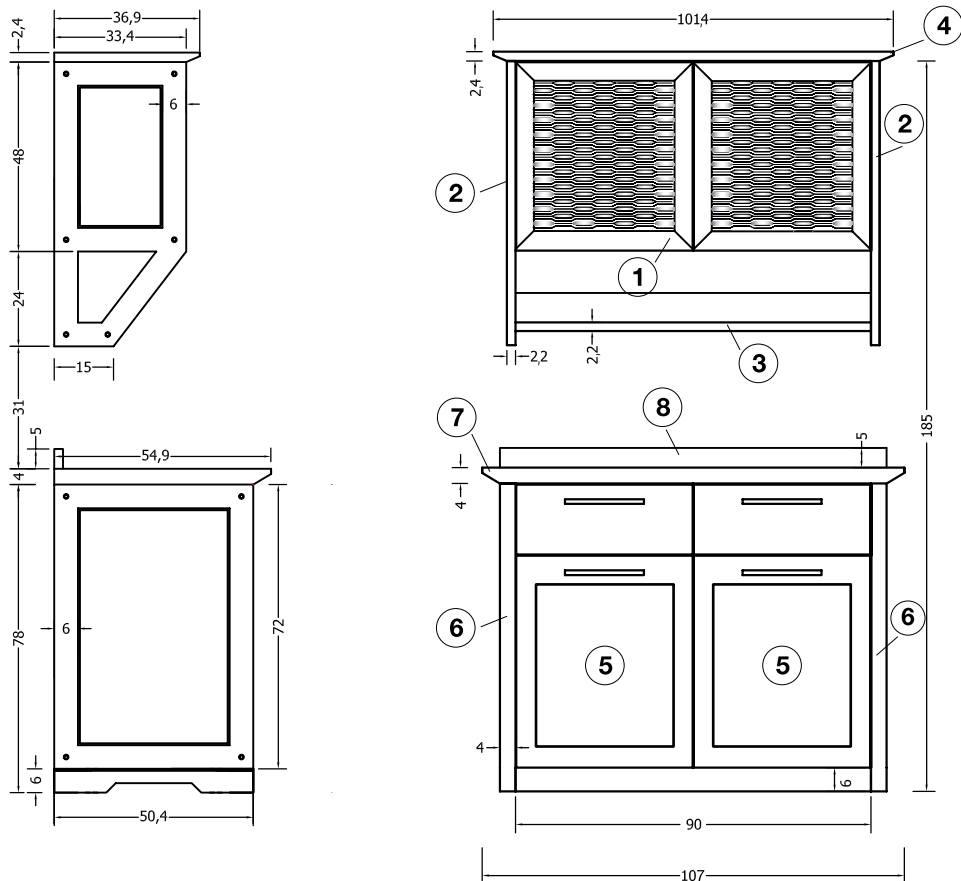

DESCRIZIONE		CODICE		
1) Pensile L 90 H 48 P 31, 2 ante telaio alluminio, presa sul fondo	cad.	G1042900		
2) Fianco pensile sagomato L 33,4 H 72 sp.2,2	cad.	12844625/6		
3) Schienale con mensola L 90 H 10,2 P 17,2	al ml	12844627		
4) Mensola soprapensile con bordo inclinato su 3 lati L 101,4 P 36,9 sp.2,4	al ml	0917358		
5) Base L 90 H 78 P 50,4, 2 cassetti H 12, 2 ante H 60	anta liscia cad.	E4022900		
	anta fresata cad.	E4022900		
6) Fianco sagomato per base H 78 P 50,4 sp.4	impiallacciato liscio cad.	12804631/2		
	laccato fresato cad.	12844631/2		
7) Top con bordo inclinato su 3 lati L 107 P 54,9 sp.4	impiallacciato al ml	TLH405		
	laccato al ml	TLC405		
8) Alzatina H 5 L 98 sp.2,2	impiallacciato al ml	TLH22A		
	laccato al ml	TLC22A		
description		code		
1) Wall unit W 90 H 48 D 31, 2 aluminium frame doors, grip on bottom opening	each	G1042900		
2) Shaped side panel W 33,4 H 72 TH.2,2 for wall unit	each	12844625/6		
3) Back panel with shelf W 90 H 10,2 D 17,2	per lm	12844627		
4) Top mounted shelf with inclined edge on 3 sides W 101,4 D 36,9 TH.2,4	per lm	0917358		
5) Base unit W 90 H 78 D 50,4, 2 drawers H 12, 2 doors H 60	smooth door each	E4022900		
	milled door each	E4022900		
6) Shaped side panel H 78 D 50,4 TH.4	smooth veneered each	12804631/2		
	milled lacquered each	12844631/2		
7) Worktop with inclined edge on 3 sides W 107 D 54,9 TH.4	veneered per lm	TLH405		
	lacquered per lm	TLC405		
8) Backsplash H 5 W 98 TH.2,2	veneered per lm	TLH22A		
	lacquered per lm	TLC22A		

# MOBILE DI COMPLEMENTO L 137

ACCESSORY FURNITURE W 137

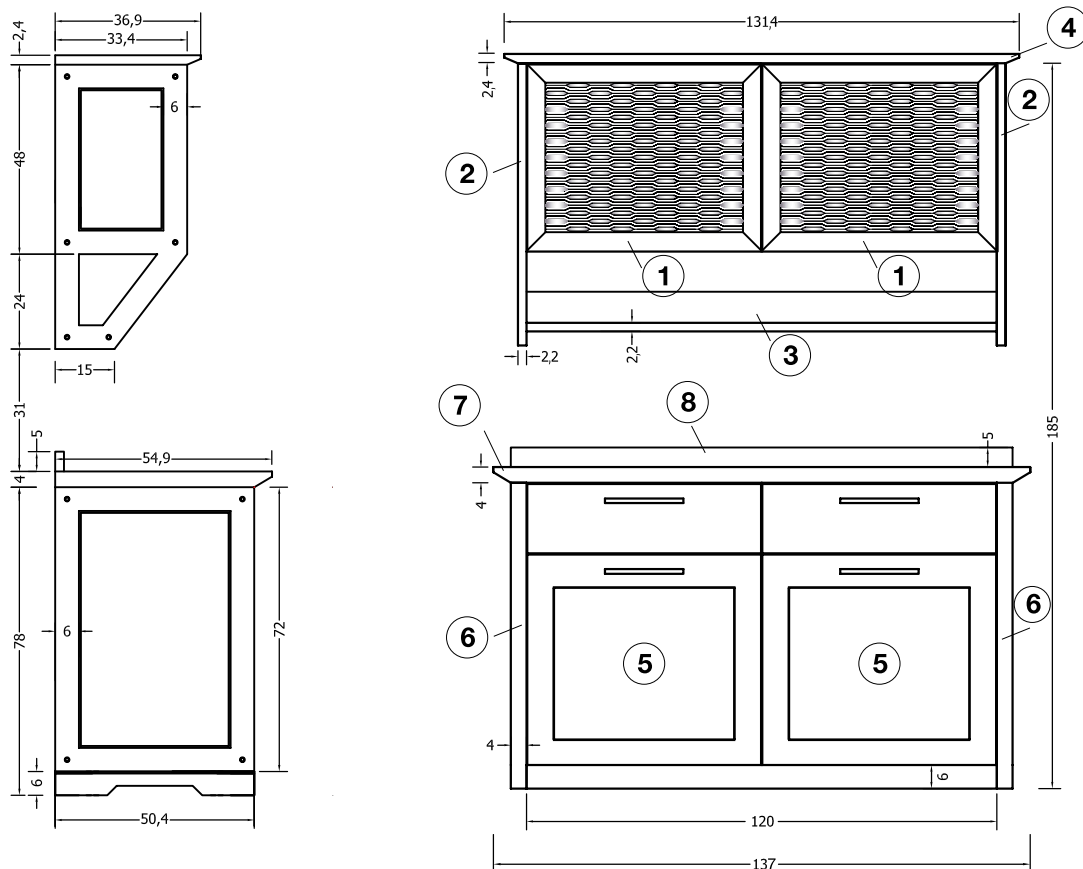

DESCRIZIONE		CODICE		
1) Pensile ribalta L 60 H 48 P 31, anta telaio alluminio, presa sul fondo	cad.	G1122600		
2) Fianco pensile sagomato L 33,4 H 72 sp.2,2	cad.	12844625/6		
3) Schienale con mensola L 120 H 10,2 P 17,5	al ml	12844627		
4) Mensola soprapensile con bordo inclinato su 3 lati L 131,4 P 36,9 sp.2,4	al ml	0917358		
5) Base L 60 H 78 P 50,4, cassetto H 12, anta H 60	anta liscia cad.	E4022681/2		
	anta fresata cad.	E4022681/2		
6) Fianco sagomato per base H 78 P 50,4 sp.4	impiallacciato liscio cad.	12804631/2		
	laccato fresato cad.	12844631/2		
7) Top con bordo inclinato su 3 lati L 137 P 54,9 sp.4	impiallacciato al ml	TLH405		
	laccato al ml	TLC405		
8) Alzatina H 5 L 128 sp.2,2	impiallacciato al ml	TLH22A		
	laccato al ml	TLC22A		
description		code		
1) Wall unit W 60 H 48 D 31, flap door with aluminium frame, grip on bottom opening	each	G1042900		
2) Shaped side panel W 33,4 H 72 TH.2,2 for wall unit	each	12844625/6		
3) Back panel with shelf W 120 H 10,2 D 17,5	per lm	12844627		
4) Top mounted shelf with inclined edge on 3 sides W 131,4 D 36,9 TH.2,4	per lm	0917358		
5) Base unit W 60 H 78 D 50,4, drawer H 12, door H 60	smooth door each	E4022900		
	milled door each	E4022900		
6) Shaped side panel H 78 D 50,4 TH.4	smooth veneered each	12804631/2		
	milled lacquered each	12844631/2		
7) Worktop with inclined edge on 3 sides W 137 D 54,9 TH.4	veneered per lm	TLH405		
	lacquered per lm	TLC405		
8) Backsplash H 5 W 128 TH.2,2	veneered per lm	TLH22A		
	lacquered per lm	TLC22A		

# MOBILE DI COMPLEMENTO L 197

ACCESSORY FURNITURE W 197

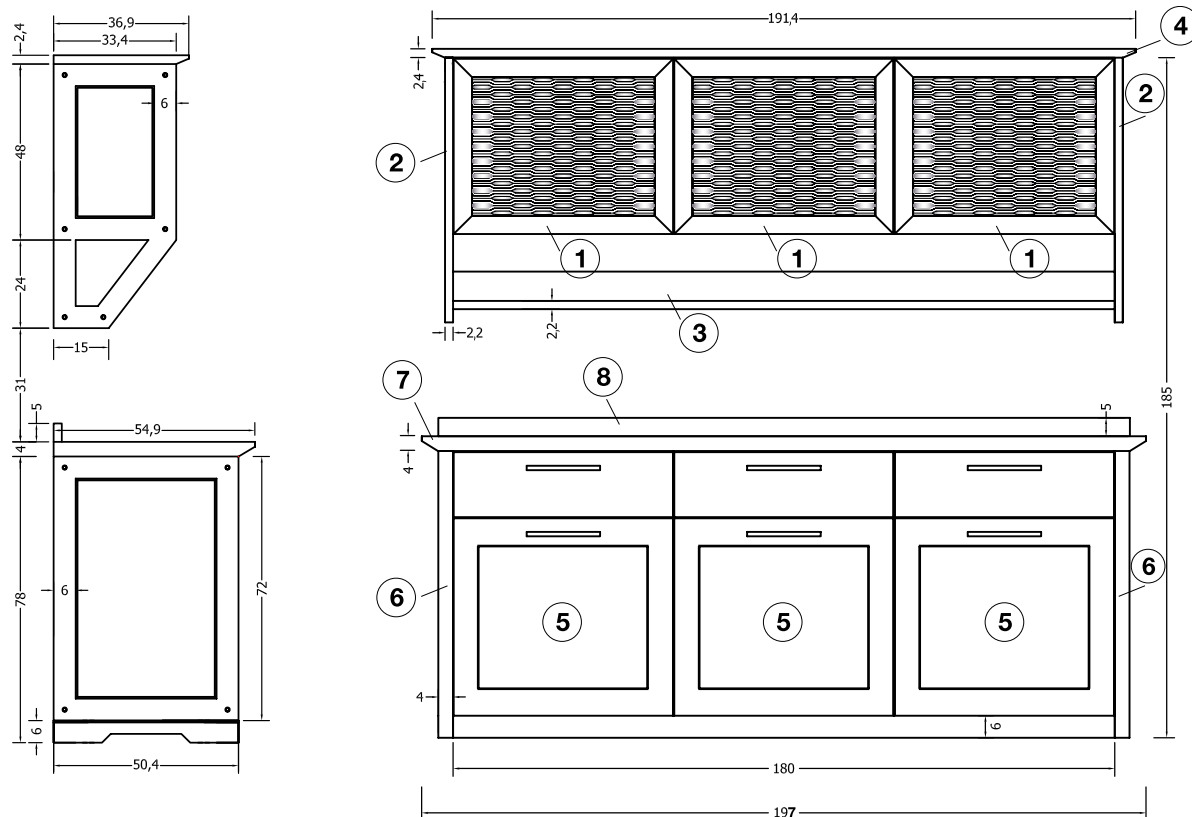

DESCRIZIONE		CODICE		
1) Pensile ribalta L 60 H 48 P 31, anta telaio alluminio con presa sul fondo	cad.	G1122600		
2) Fianco pensile sagomato L 33,4 H 72 sp.2,2	cad.	12844625/6		
3) Schienale con mensola L 180 H 10,2 P 17,5	al ml	12844627		
4) Mensola soprapensile con bordo inclinato su 3 lati L 191,4 P 36,9 sp.2,4	al ml	0917358		
5) Base L 60 H 78 P 50,4, cassetto H 12, anta H 60	anta liscia cad.	E4022681/2		
	anta fresata cad.	E4022681/2		
6) Fianco sagomato per base H 78 P 50,4 sp.4	impiallacciato liscio cad.	12804631/2		
	laccato fresato cad.	12844631/2		
7) Top con bordo inclinato su 3 lati L 197 P 54,9 sp.4	impiallacciato al ml	TLH405		
	laccato al ml	TLC405		
8) Alzatina H 5 L 188 sp.2,2	impiallacciato al ml	TLH22A		
	laccato al ml	TLC22A		
description		code		
1) Wall unit W 60 H 48 D 31, flap door with aluminium frame, grip on bottom opening	each	G1042900		
2) Shaped side panel W 33,4 H 72 TH.2,2 for wall unit	each	12844625/6		
3) Back panel with shelf W 180 H 10,2 D 17,5	per lm	12844627		
4) Top mounted shelf with inclined edge on 3 sides W 191,4 D 36,9 TH.2,4	per lm	0917358		
5) Base unit W 60 H 78 D 50,4, drawer H 12, door H 60	smooth door each	E4022900		
	milled door each	E4022900		
6) Shaped side panel H 78 D 50,4 TH.4	smooth veneered each	12804631/2		
	milled lacquered each	12844631/2		
7) Worktop with inclined edge on 3 sides W 197 D 54,9 TH.4	veneered per lm	TLH405		
	lacquered per lm	TLC405		
8) Backsplash H 5 W 188 TH.2,2	veneered per lm	TLH22A		
	lacquered per lm	TLC22A		

# PANNELLI ACCESSORIATI CON TELAIO ALLUMINIO

FITTED PANELS WITH ALUMINIUM FRAME



## COLORI TELAIO E ACCESSORI IN ALLUMINIO

ALUMINIUM FRAME AND ACCESSORIES COLOURS



urban (opt.NU)  
urban (opt.NU)

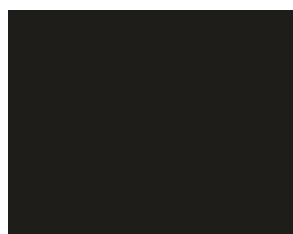

nero (opt.7892)  
black (opt.7892)



titanio (opt.414)  
titanium (opt.414)



# COLORI PANNELLI

COLOURS FOR PANELS

## PANNELLO IMPIALLACCIATO

VENEERED PANEL



rovere bianco invecchiato  
(opz.5380)  
white aged oak (opt.5380)



rovere juta invecchiato  
(opz.5381)  
jute aged oak (opt.5381)



rovere corteccia invecchiato  
(opz.5382)  
bark aged oak (opt.5382)



rovere mielato invecchiato  
(opz.5383)  
honey aged oak (opt.5383)



rovere antracite invecchiato  
(opz.5384)  
anthracite aged oak  
(opt.5384)



rovere argilla invecchiato  
(opz.5385)  
clay aged oak (opt.5385)

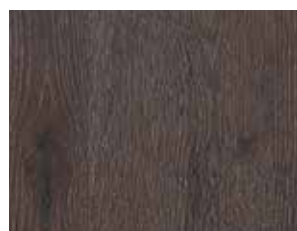

rovere moro invecchiato  
(opz.5386)  
dark aged oak (opt.5386)



rovere grigio terra (opz.5389)  
grey earth oak (opt.5389)



rovere naturale invecchiato  
parquettato (opz.5387)  
parquet-effect natural  
aged oak (opt.5387)



rovere madera termocotto  
(opz.5388)  
heat treated madera oak  
(opt.5388)

## PANNELLO FENIX

FENIX PANEL

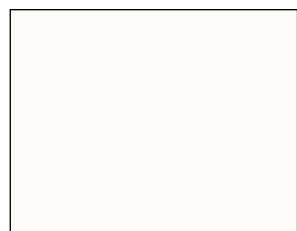

bianco caldo (opz.7446)  
warm white (opt.7446)



castoro (opz.8864)  
beaver (opt.8864)

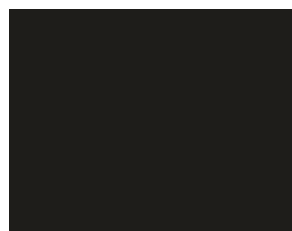

nero (opz.7861)  
black (opt.7861)



grigio bromo (opz.9628)  
bromine grey (opt.9628)



fumo (opz.9629)  
smoke (opt.9629)



bianco dover (opz.7449)  
dover white (opt.7449)



cacao orinoco (opz.8865)  
cocoa orinoco (opt.8865)



beige arizona (opz.7705)  
arizona beige (opt.7705)



grigio efeso (opz.9630)  
ephesus grey (opt.9630)

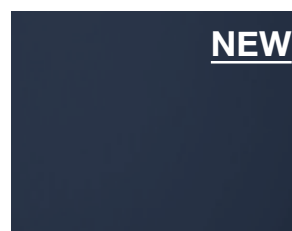

blu fes (opz.8301)  
blue fes (opt.8301)



# VIVI IL LIVING

LIVE THE LIVING

**Vasta gamma di soluzioni e totale modularità per creare nuove composizioni living adatte ad ogni spazio.**

Wide range of solutions and totaly of modules to create new lively furnishing compositions suitable for every kind of space.



# LIBRERIA LIVING

## LIVING BOOKCASE







La libreria va ad ampliare la gamma living con spessore e carattere. La sua struttura sp.2,5 è perfettamente coordinata alla cucina grazie alla possibilità di integrare le ante del programma Oltre.

**N.B.: per una corretta preventivazione ed ordine delle librerie, si consiglia l'uso del programma 3cad Evolution**

The bookcase expands the living range with substance and character. His th. 2,5 structure is perfectly coordinated with the kitchen, thanks to the possibility to integrate the door finishes of Oltre program.

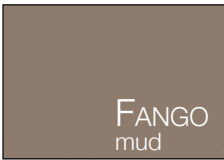
**Note: we recommend to use the 3cad Evolution software, for having a correct estimate and order.**

### FINITURE STRUTTURA SP.2,5 - SCHIENA SP.1 STRUCTURE FINISHES TH.2,5 - BACK PANEL TH.1

MELAMINICO melamine	 BIANCO white	 VISONE mink	 FANGO mud	 LAVAGNA slate grey	 ARGILLA clay	 CONCHIGLIA shell
LACCATO OPACO matt lacquered	N.B.: per i colori vedi pag.34 Note: for colours see page 34					

### FINITURE ANTE DOORS FINISHES

 IMPIALLACCIATO veneered	 FENIX	 LACCATO lacquered
--	---	--



# LIVING LO 01



ANTE  
doors

IMPIALLACCIATO  
veneered

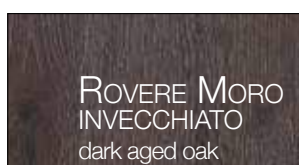

LACCATO OPACO  
matt lacquered

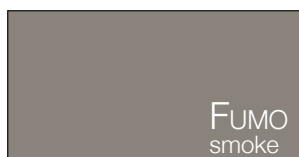

STRUTTURA  
carcass

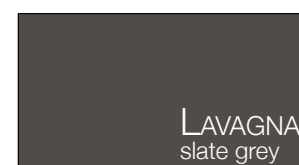

# LIVING LO 01

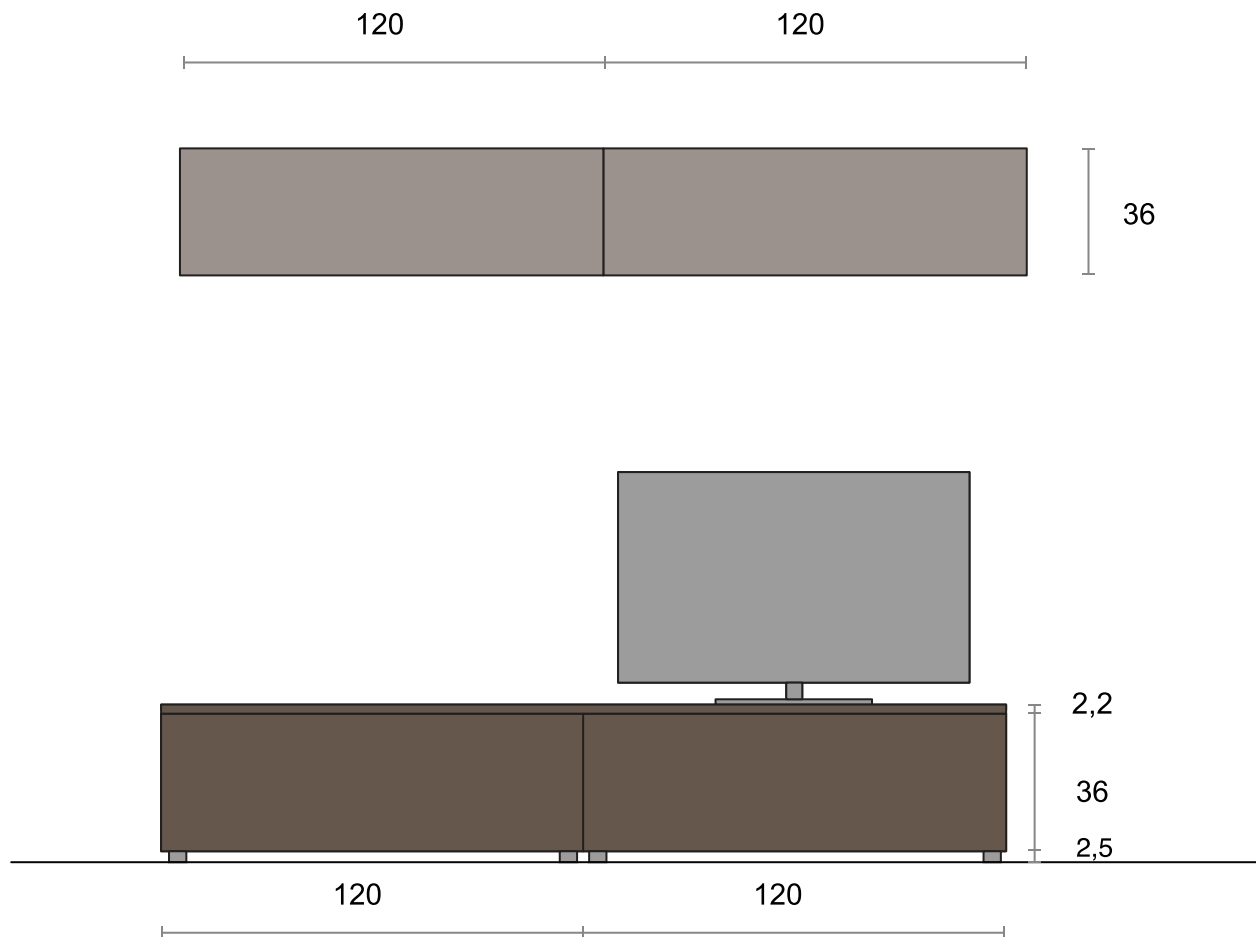

NR. ELEMENTI	DESCRIZIONE	CODICE
2	Base living L 120 H 24 P 50,4, cestone apertura tip-on, 1 fianco come anta	EBL26200
2	Pensile L 120 H 36 P 33,4 apertura tip-on	E210120T
2	Coprifianco H 36 P 31 laccato opaco come anta	T98340
1	Top impiallacciato L 120,2 P 50,4 SP. 2,2	al ml TLH225
2	Asta appendipensili ml 2	08610501
No. of ELEMENTS	DESCRIPTION	CODE
2	Living base unit W 120 H 24 D 50,4, deep drawer tip-on opening, 1 side same as door	EBL26200
2	Wall unit W 120 H 36 D 33,4 flap door opening	E210120T
2	Matt lacquered side panel H 36 D 31, same colour as door	T98340
1	Veneered worktop W 120,2 D 50,4 TH. 2,2	per lm TLH225
2	Wall unit fixing strip lm 2	08610501

# LIVING LO 02



ANTE  
doors

IMPIALLACCIATO  
veneered

ROVERE NATURALE  
INVECCHIATO  
PARQUETTATO  
parquet-effect natural aged oak

LACCATO OPACO  
matt lacquered

BIANCO ASSOLUTO  
absolute white

LACCATO OPACO  
matt lacquered

BISTRO  
bistro

STRUTTURA  
carcass

FANGO  
mud

BIANCO  
white

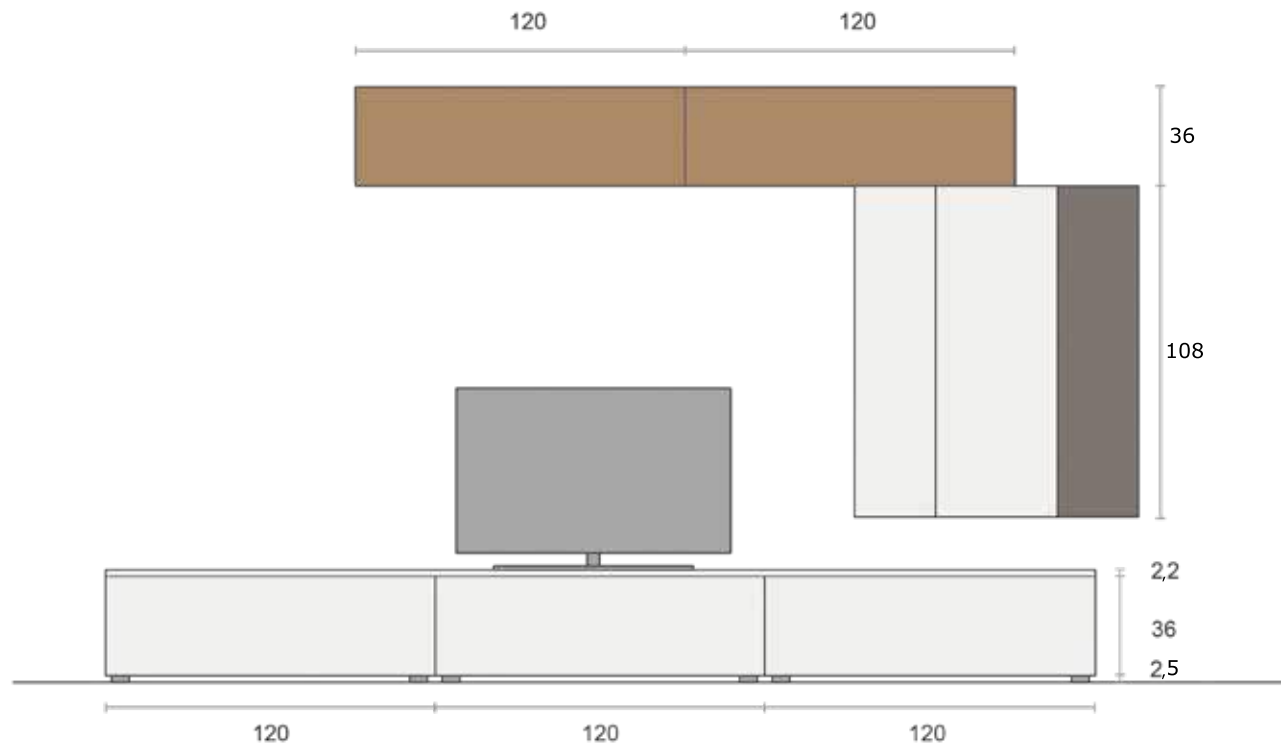

NR. ELEMENTI	DESCRIZIONE	CODICE
2	Pensile L 120 H 36 P 33,4 apertura tip-on, 1 fianco come anta	E210120T
2	Pensile L 30 H 108 P 33,4 apertura push-pull	E2144301/2
2	Coprifianco H 108 P 31 laccato opaco come anta	T98362
1	Pensile L 45 H 108 P 33,4 apertura push-pull	E2144451/2
3	Base living L 120 H 38,5 P 50,4, cestone apertura tip-on	EBL26200
2	Coprifianco H 36 P 48 laccato opaco come anta	T983382
1	Top L 360 P 50,4 SP. 2,2 laccato opaco come anta	al ml TLC225
4	Asta appendipensili ml 2	08610501

No. of ELEMENTS	DESCRIPTION	CODE
2	Wall unit W 120 H 36 D 33,4, tip-on opening, 1 side same as door	E210120T
2	Wall unit W 30 H 108 D 33,4 push-pull opening	E2144301/2
2	Matt lacquered side panel H 108 D 31 same as door	T98362
1	Wall unit W 45 H 108 D 33,4 push-pull opening	E2144451/2
3	Living base unit W 120 H 38,5 D 50,4, deep drawer tip-on opening	EBL26200
2	Matt lacquered side panel H 36 D 48, same as door	T983382
1	Matt lacquered worktop W 360 D 50,4 TH. 2,2 same as door	per lm TLC225
4	Wall unit fixing strip lm 2	08610501



# LIVING A SPALLA LO 02



ELEMENTI A GIORNO  
LACCATI OPACHI  
matt lacquered open units

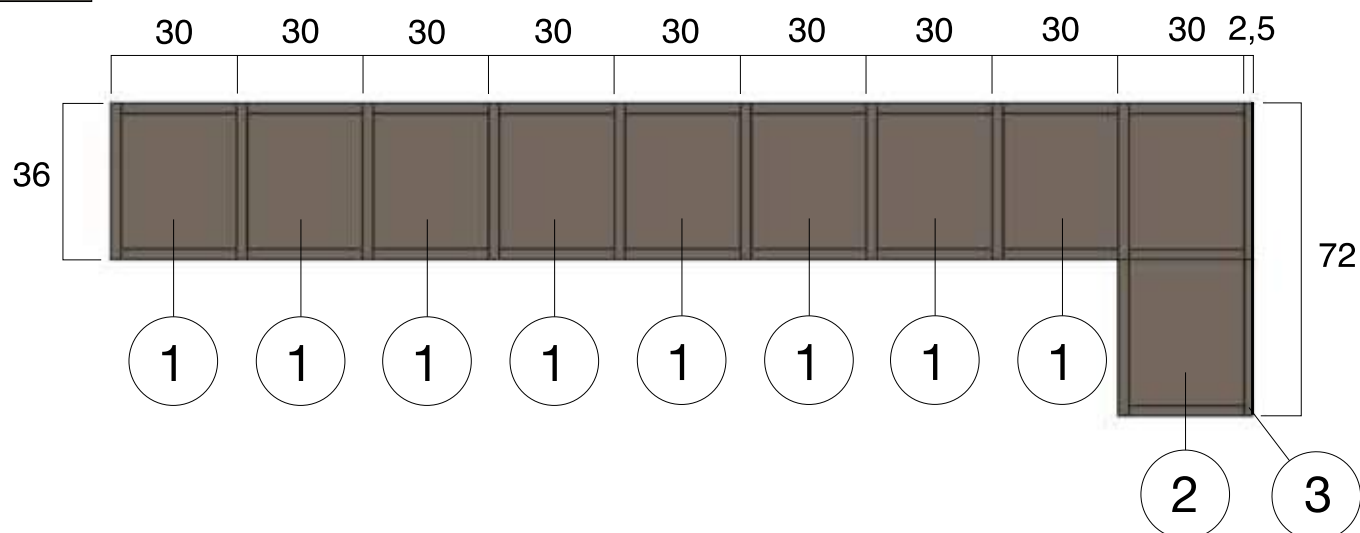

# LIVING A SPALLA LO 03



ANTE  
doors

SCHIENA  
back panel

STRUTTURA  
carcass

IMPIALLACCIATO  
veneered

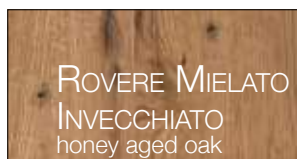

MELAMINICO  
melamine

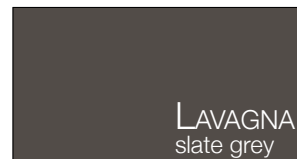

MELAMINICO  
melamine

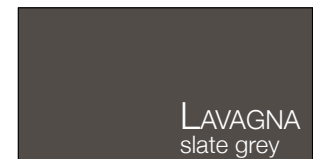

LACCATO OPACO  
matt lacquered

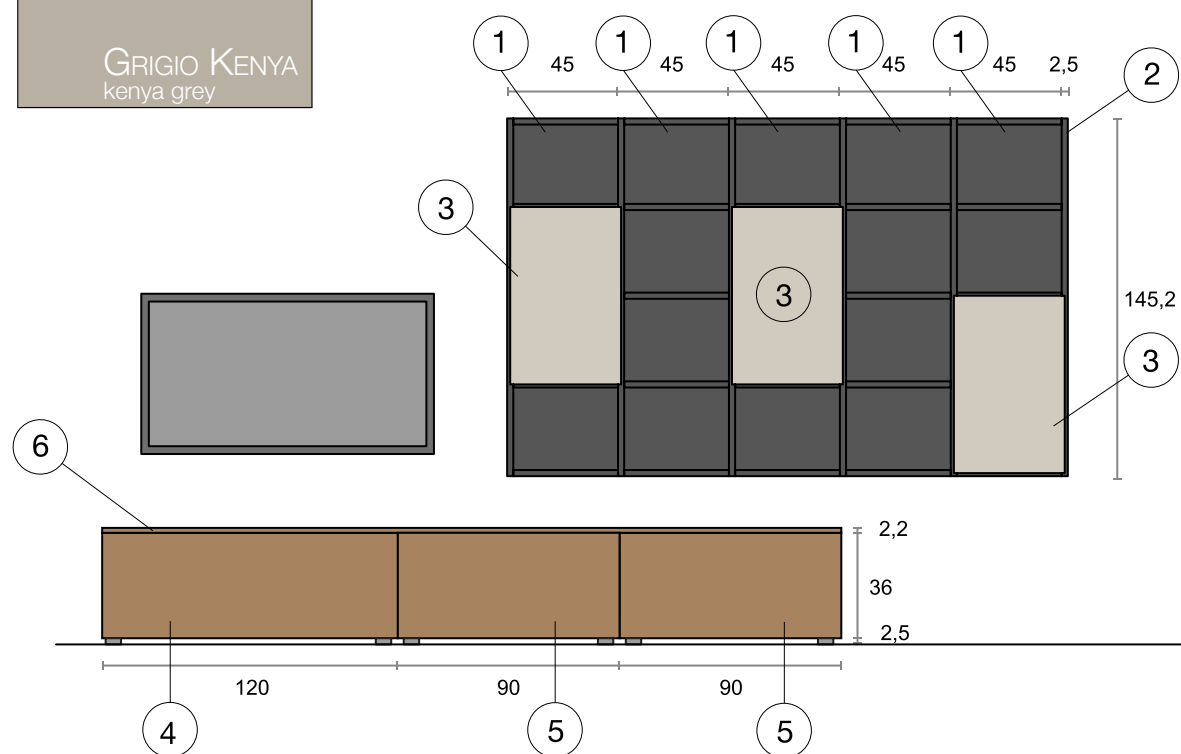

# LIVING A SPALLA LO 05



ANTE  
doors

SCHIENA  
back panel

STRUTTURE  
carcasses

IMPIALLACCIATO  
veneered



LACCATO OPACO  
matt lacquered



LACCATO OPACO  
matt lacquered



LACCATO OPACO  
matt lacquered

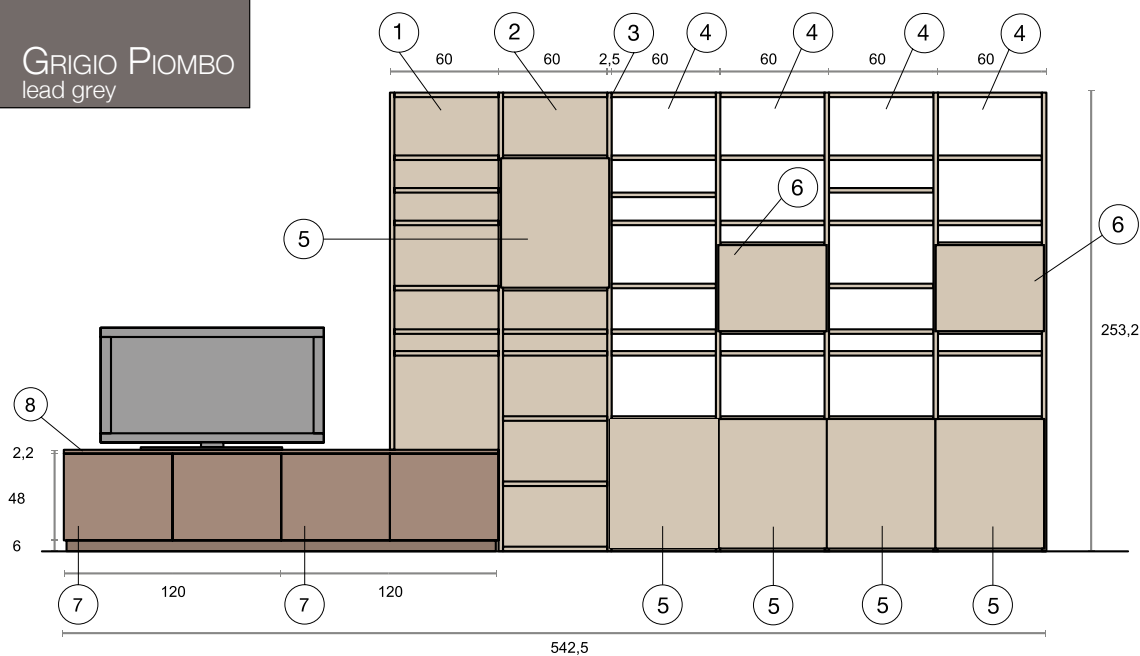
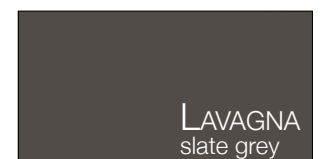

# LIVING A SPALLA BIFACCIALE LO 06



ANTA  
door

STRUTTURA  
carcass

LACCATO OPACO  
matt lacquered

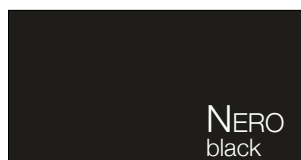

MELAMINICO  
melamine

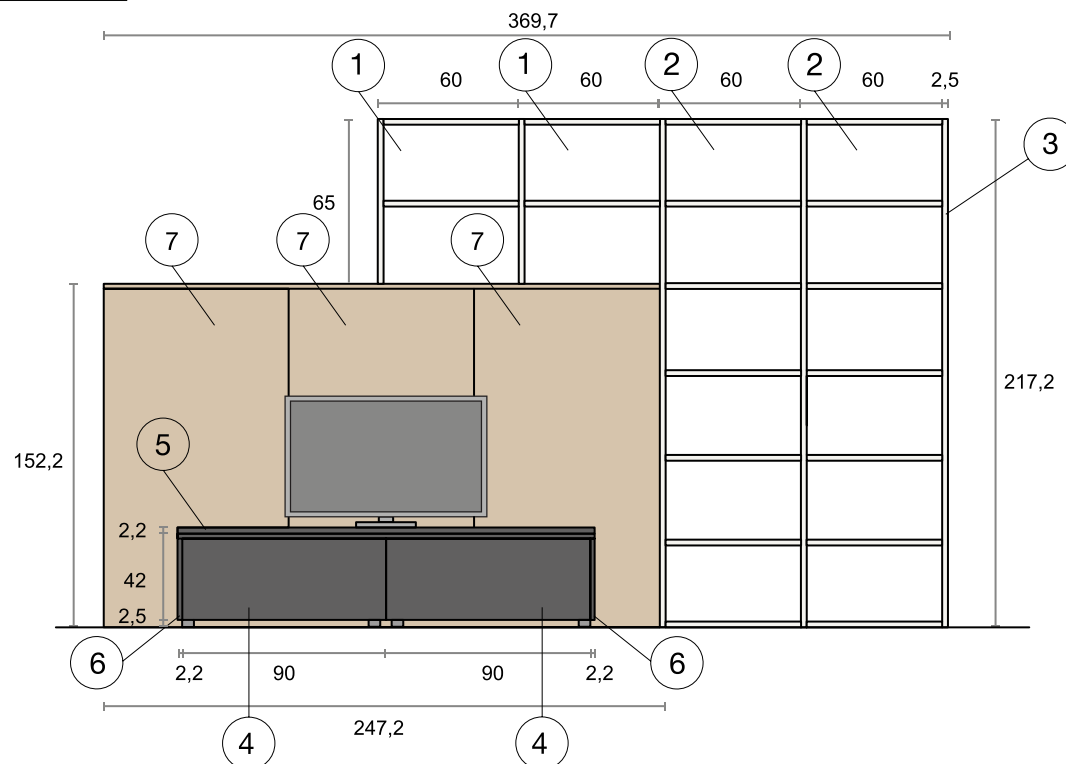
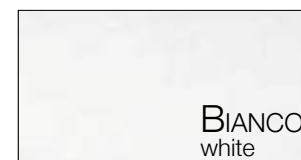

# LIVING A SPALLA LO 07



SCHIENA  
back panel

LACCATO OPACO  
matt lacquered



LACCATO OPACO  
matt lacquered

STRUTTURA  
carcass

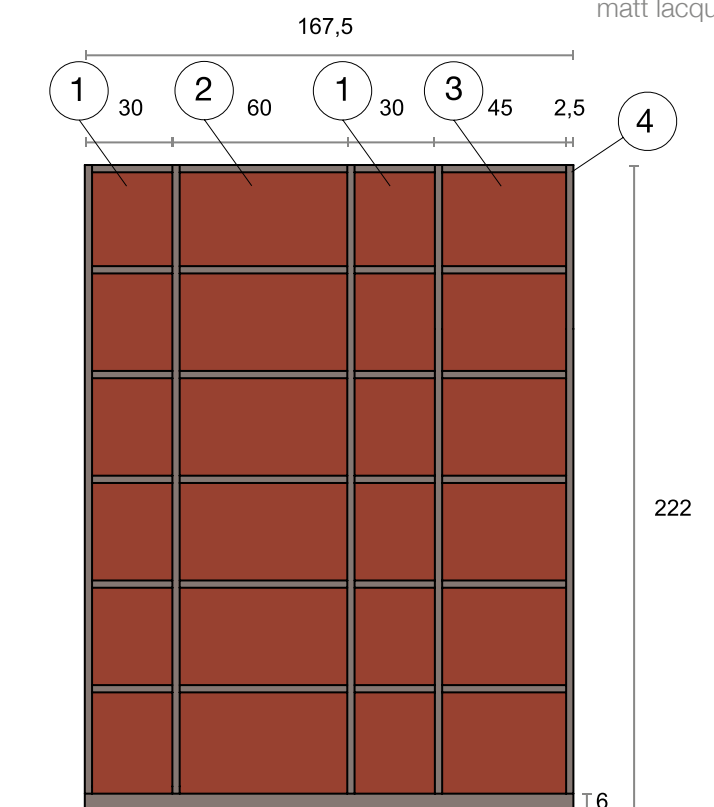
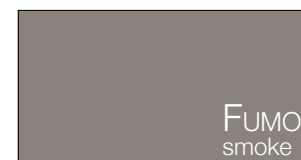

# LIVING A SPALLA LO 08



ANTA  
door

SCHIENA  
back panel

STRUTTURA  
carcass

IMPIALLACCIATO  
veneered

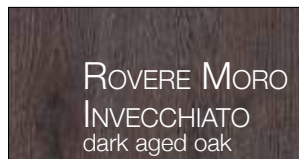

LACCATO OPACO  
matt lacquered

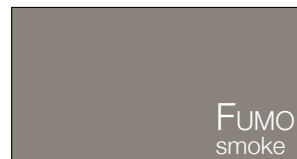

MELAMINICO  
melamine

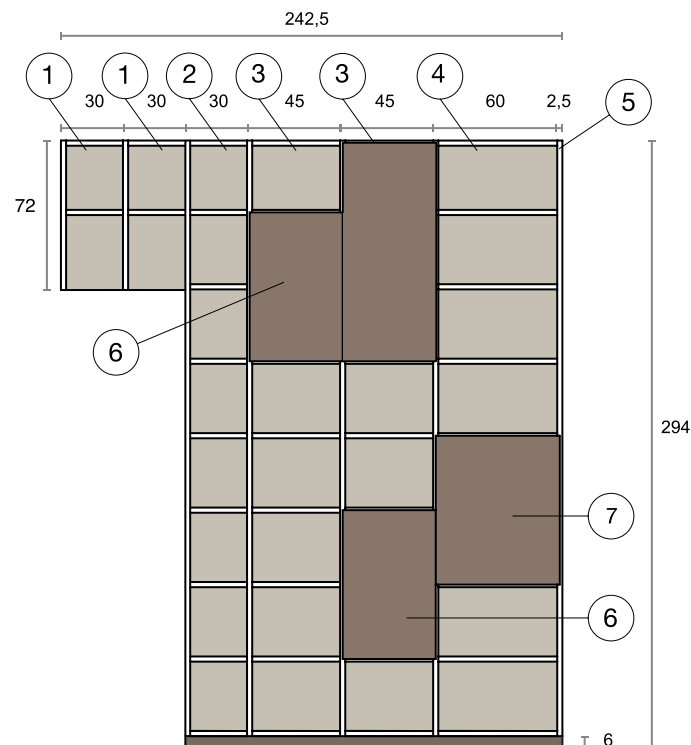
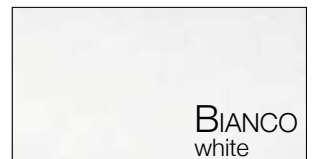

# LIVING A SPALLA LO 10



ANTA  
door

SCHIENA  
back panel

STRUTTURA  
carcass

LACCATO OPACO  
matt lacquered



LACCATO OPACO  
matt lacquered



LACCATO OPACO  
matt lacquered

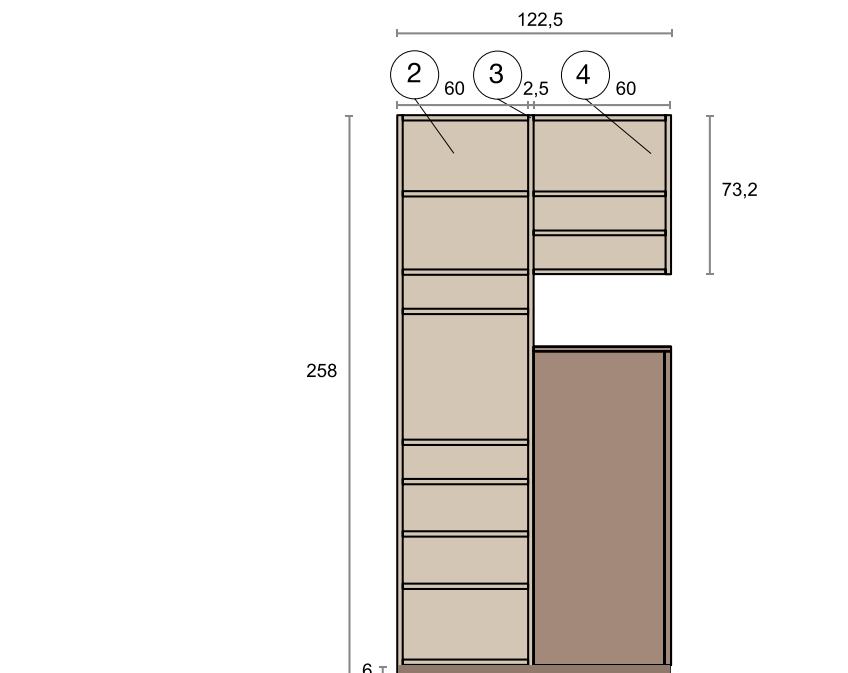
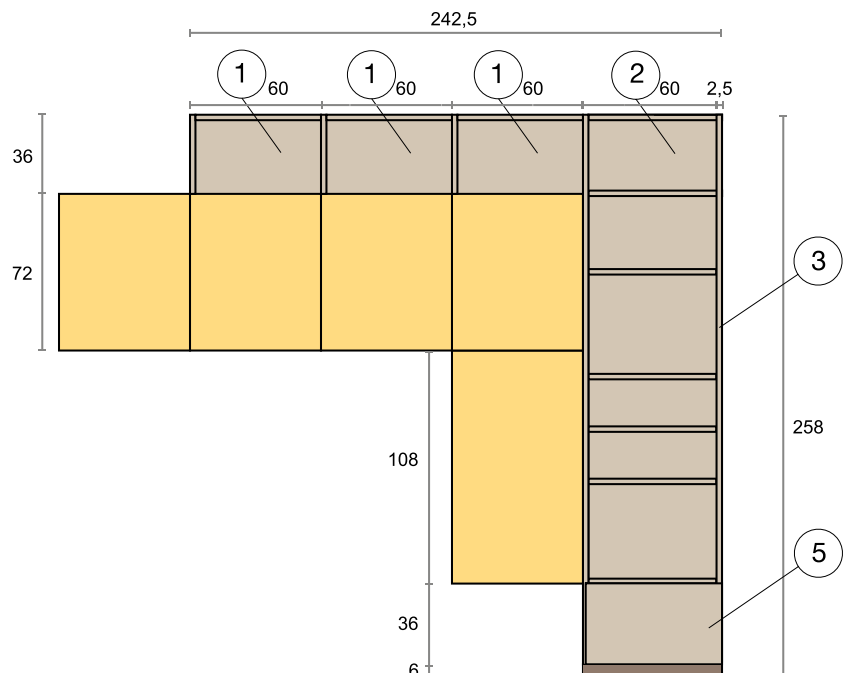

# LIVING A SPALLA LO 11



ANTA  
door

SCHIENA  
back panel

STRUTTURA  
carcass

LACCATO OPACO  
matt lacquered



LACCATO OPACO  
matt lacquered



LACCATO OPACO  
matt lacquered

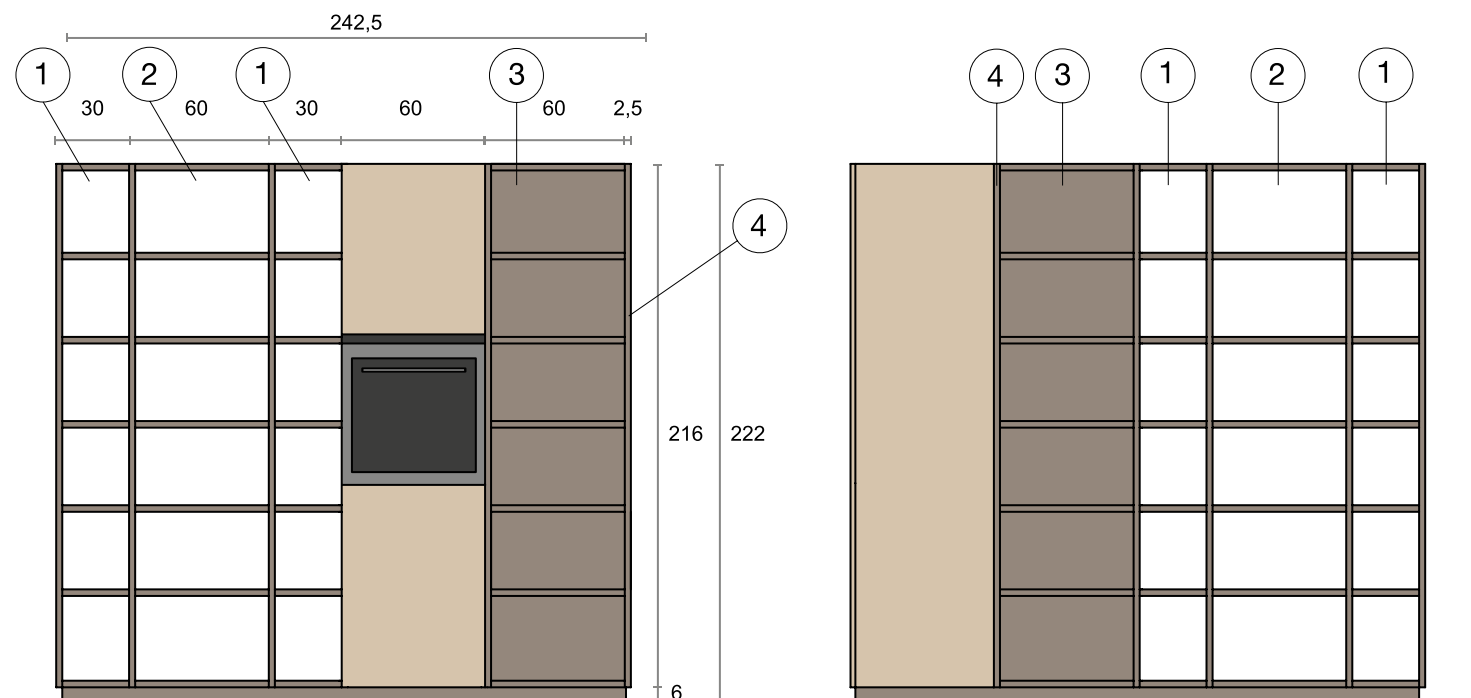



# LIVING A SPALLA LO 13



SCHIENA  
back panel

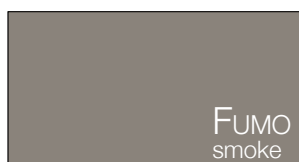

LACCATO OPACO  
matt lacquered

MELAMINICO  
melamine

STRUTTURA  
carcass

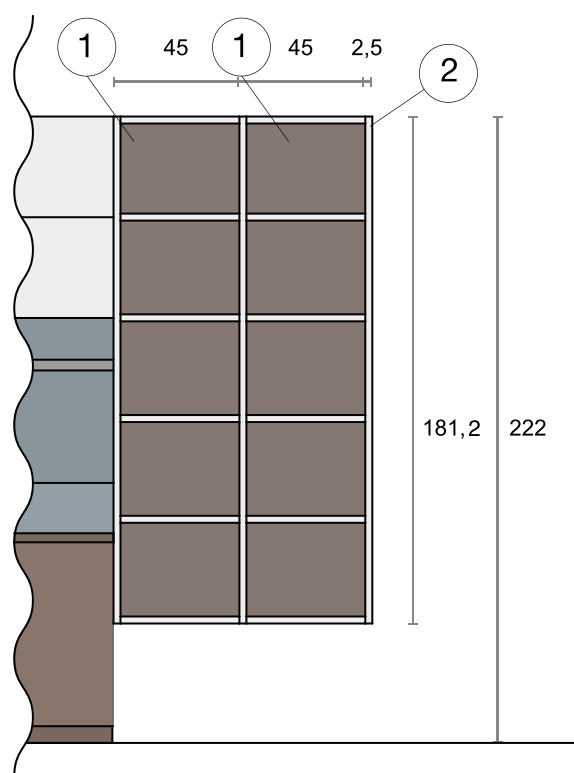
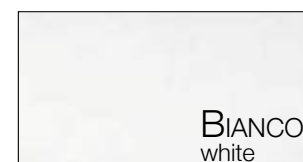

# STRUTTURA A PARETE TOWER HI-LINE

## TOWER HI-LINE WALL MOUNTED STRUCTURE

Struttura con cremagliera passo 4 cm corredata di piastre per fissaggio carterizzate e regolatori di posizionamento in altezza. Coppia distanziatori amovibili. Disponibile nelle larghezze L 60 e L 90 entrambe nelle altezze H 270 (regolabile da 268 a 280), H 300 (regolabile da 288 a 300)

Rack system structure gap 4 cm provided with enclosed fixing plates and positioning regulators in height. Removable spacer pair. Available in L 60 and L 90 widths and both available in heights H 270 (adjustable from 268 to 280), H 300 (adjustable from 288 to 300)

VISTA FRONTALE  
FRONT VIEW

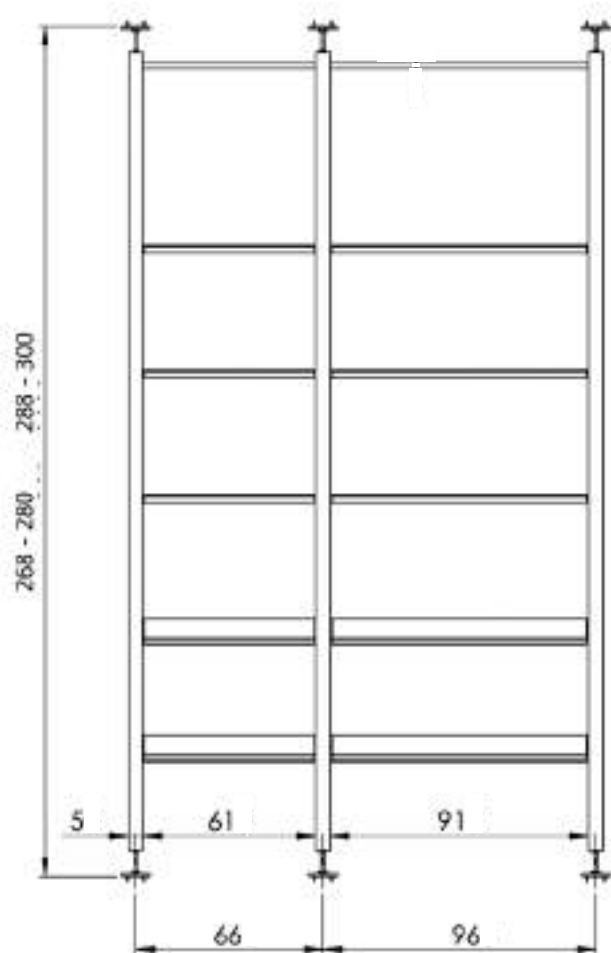

VISTA LATERALE  
SIDE VIEW

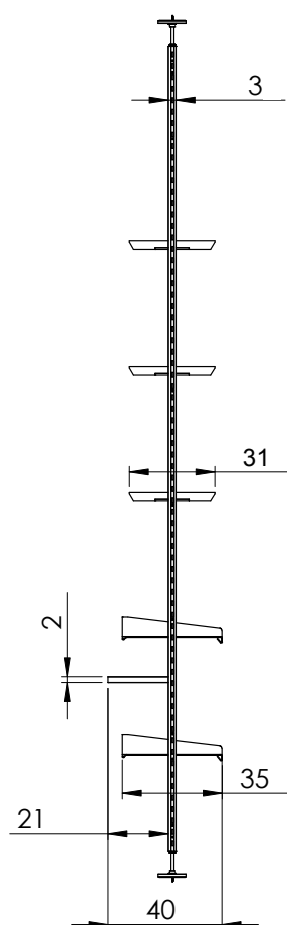

PARTICOLARE

Dettaglio della cremagliera per regolare la posizione delle mensole su tutta l'altezza del telaio

Rack system detail for adjust the position of shelves over the whole heigh of the frame

VISTA SUPERIORE  
TOP VIEW

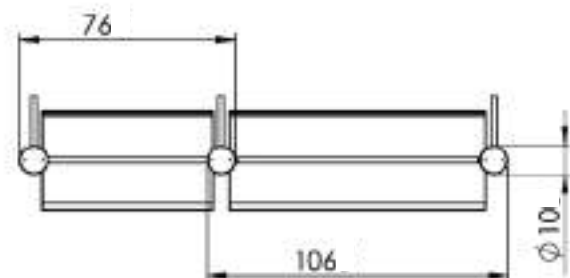

# STRUTTURA A PARETE TOWER HI-LINE MODULARITÀ

TOWER HI-LINE WALL MOUNTED STRUCTURE MODULARITY

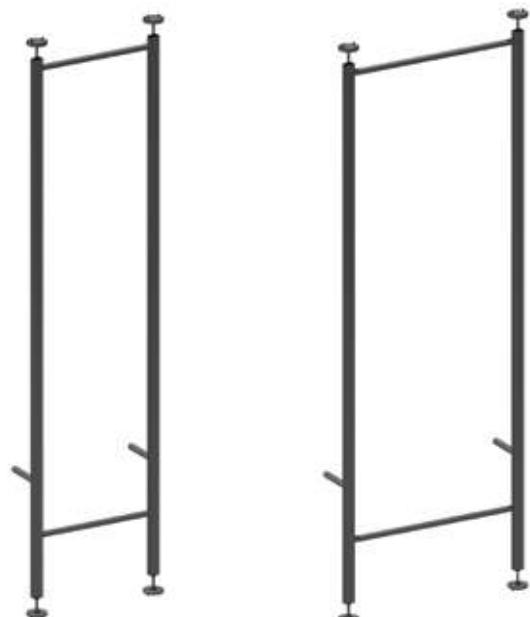

L 60

L 90

**STRUTTURA A PARETE IN METALLO H 270 (regolabile da 268 a 280)  
H 300 (regolabile da 288 a 300)**

**Composto da:**

- 2 cremagliere corredate di piastre per fissaggio
- 2 distanziatori amovibili (60 - 90)

Metal wall mounted structure H 270 (adjustable from 268 to 280)  
H 300 (adjustable from 288 to 300)

Consist of:

- 2 racks equipped provided with enclosed fixing plates
- 2 removable spacers (60 - 90)

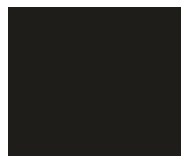

nero (opz.AL11)  
black (opt.AL11)



titanio (opz.AL12)  
titanium (opt.AL12)

**H 270**

L 60 cod.0890400

L 90 cod.0890405

**H 300**

L 60 cod.0890410

L 90 cod.0890415



**MONTANTE A PARETE IN METALLO H 270 (regolabile da 268 a 280)  
H 300 (regolabile da 288 a 300)**

**Composto da:**

- 1 cremagliera corredata di piastre per fissaggio
- 2 distanziatori amovibili (60 - 90)

Metal wall mounted pillar H 270 (adjustable from 268 to 280)  
H 300 (adjustable from 288 to 300)

Consist of:

- 1 rack equipped provided with enclosed fixing plates
- 2 removable spacers (60 - 90)



nero (opz.AL11)  
black (opt.AL11)

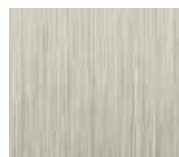

titanio (opz.AL12)  
titanium (opt.AL12)

**H 270**

L 60 cod.0890402

L 90 cod.0890407

**H 300**

L 60 cod.0890412

L 90 cod.0890417



# STRUTTURA AD ISOLA TOWER HI-LINE

MINK MATT ACRYLIC BOOKCASE TOWER HI-LINE ISLAND LIVING AREA ELEMENTS STRUCTURE

Struttura con cremagliera passo 4 cm corredata di piastre per fissaggio carterizzate e regolatori di posizionamento in altezza. Coppia distanziatori amovibili.

Disponibile nelle larghezze L 60 e L 90 entrambe nell' altezza H 270 (regolabile da 268 a 280)

Rack system structure gap 4 cm provided with enclosed fixing plates and positioning regulators in height. Removable spacer pair.

Available in L 60 and L 90 widths and both available in height H 270 (adjustable from 268 to 280)

VISTA FRONTALE  
FRONT VIEW

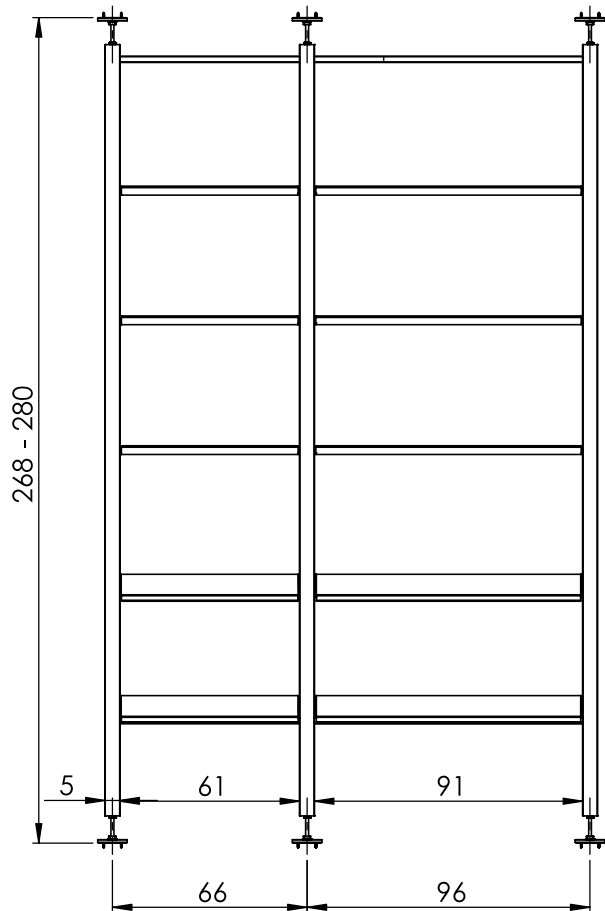

VISTA LATERALE  
SIDE VIEW

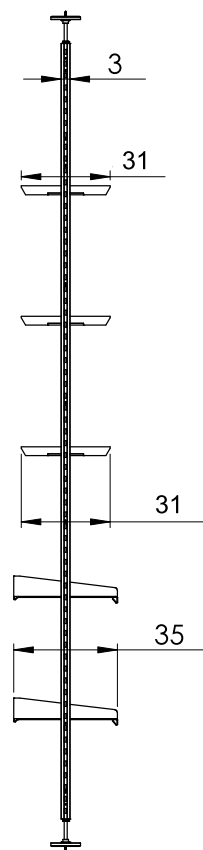

PARTICOLARE

Dettaglio della cremagliera per regolare la posizione dei ripiani su tutta l'altezza del telaio

Rack system detail for adjust the position of shelves over the whole height of the frame

VISTA SUPERIORE  
TOP VIEW

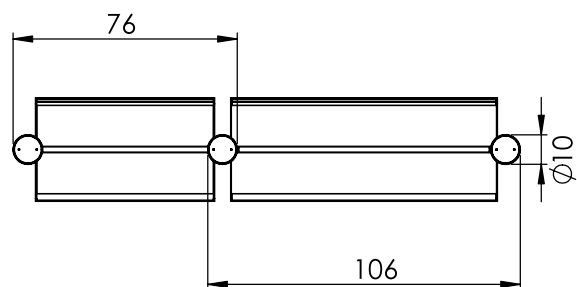

# STRUTTURA CONTENITIVA AD ISOLA TOWER HI-LINE MODULARITÀ

TOWER HI-LINE ISLAND CONTAINMENT STRUCTURE MODULARITY

STRUTTURA AD ISOLA IN METALLO H 270 (regolabile da 268 a 280)

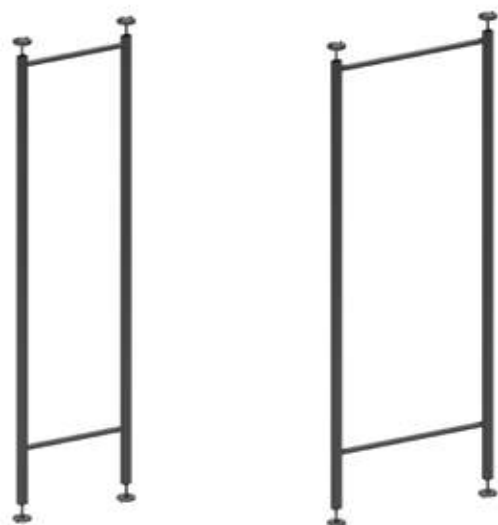

L 60

L 90

Composto da:

- 2 cremagliere corredate di piastre per fissaggio
- 2 distanziatori amovibili (60 - 90)

Metal island structure H 270 (adjustable from 268 to 280)

Consist of:

- 2 racks equipped provided with enclosed fixing plates
- 2 removable spacers (60 - 90)

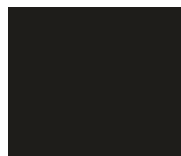

nero (opz.AL11)  
black (opt.AL11)



titanio (opz.AL12)  
titanium (opt.AL12)

L 60 cod.0890400

L 90 cod.0890405

MONTANTE AD ISOLA IN METALLO H 270 (regolabile da 268 a 280)



Composto da:

- 1 cremagliera corredata di piastre per fissaggio
- 2 distanziatori amovibili (60 - 90)

Metal island pilar H 270 (adjustable from 268 to 280)

Consist of:

- 1 rack equipped provided with enclosed fixing plates
- 2 removable spacers (60 - 90)



nero (opz.AL11)  
black (opt.AL11)



titanio (opz.AL12)  
titanium (opt.AL12)

L 60 cod.0890402

L 90 cod.0890407



# MENSOLE PER STRUTTURA TOWER HI-LINE

SHELVES FOR TOWER HI-LINE STRUCTURE

**MENSOLA IN ALLUMINIO L 60-90 P 35 completa di agganci per cremagliera**

Aluminium shelf W 60-90 D 35 complete of rack hooks

**Colori disponibili: nero e titanio**

Available colours: black and titanium

**N.B.: per la corretta stabilità inserire almeno 4 mensole per modulo**

Note: to guarantee the correct stability of the structure, insert at least 4 shelves for any module

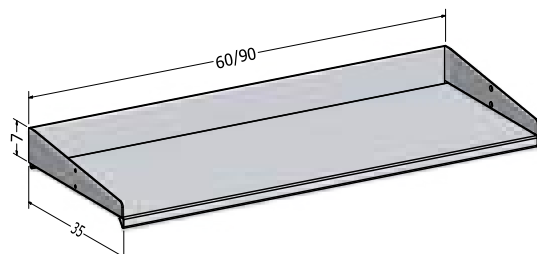

nero (opz.AL11)  
black (opt.AL11)



titanio (opz.AL12)  
titanium (opt.AL12)

L 60 cod.0890425

L 90 cod.0890426

**MENSOLA SAGOMATA PER STRUTTURA A PARETE L 60-90 P 31 completa di agganci per cremagliera**

shaped shelf for wall mounted structure W 60-90 D 31 complete of rack hooks

**Finiture disponibili: fenix, impiallacciata (per colori vedi pag.400)**

Available finishes: fenix, veneered (for colours see page 400)

**N.B.: per la corretta stabilità inserire almeno 4 mensole per modulo**

Note: to guarantee the correct stability of the structure, insert at least 4 shelves for any module

FENIX

L 60 cod.0890432

L 90 cod.0890442

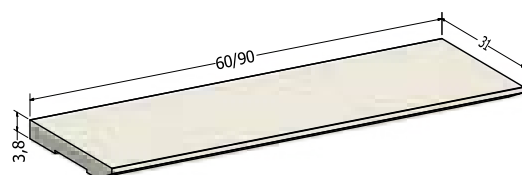

IMPIALLACCIATA - VENEERED

L 60 cod.0890436

L 90 cod.0890446

LACCATO OPACO - MATT LACQURED

L 60 cod.0890438

L 90 cod.0890448

**MENSOLA SAGOMATA PER STRUTTURA A ISOLA L 60-90 P 31 completa di agganci per cremagliera**

shaped shelf for island structure W 60-90 D 31 complete of rack hooks

**Finiture disponibili: fenix, impiallacciata (per colori vedi pag.400)**

Available finishes: fenix, veneered (for colours see page 400)

**N.B.: per la corretta stabilità inserire almeno 4 mensole per modulo**

Note: to guarantee the correct stability of the structure, insert at least 4 shelves for any module

FENIX

L 60 cod.0890431

L 90 cod.0890441

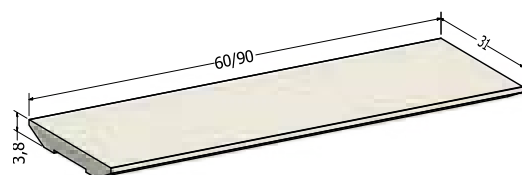

IMPIALLACCIATA - VENEERED

L 60 cod.0890435

L 90 cod.0890445

LACCATO OPACO - MATT LACQURED

L 60 cod.0890437

L 90 cod.0890447

# FINITURE MENSOLE ED ELEMENTI TOWER HI-LINE

SHELVES AND ELEMENTS FINISHES FOR TOWER HI-LINE

FENIX (solo per mensole - only for shelves)

<p>bianco caldo (opz.7446) warm white (opt.7446)</p>	<p>castoro (opz.8864) beaver (opt.8864)</p>	<p>nero (opz.7861) black (opt.7861)</p>	<p>grigio bromo (opz.9628) bromine grey (opt.9628)</p>	<p>fumo (opz.9629) smoke (opt.9629)</p>
<p><b>NEW</b></p> <p>bianco dover (opz.7449) dover white (opt.7449)</p>	<p><b>NEW</b></p> <p>cacao orinoco (opz.8865) cocoa orinoco (opt.8865)</p>	<p><b>NEW</b></p> <p>beige arizona (opz.7705) arizona beige (opt.7705)</p>	<p><b>NEW</b></p> <p>grigio efeso (opz.9630) ephesus grey (opt.9630)</p>	<p><b>NEW</b></p> <p>blu fes (opz.8301) blue fes (opt.8301)</p>

## IMPIALLACCIATI

VENEERED

<p>rovere bianco invecchiato (opz.5380) white aged oak (opt.5380)</p>	<p>rovere juta invecchiato (opz.5381) jute aged oak (opt.5381)</p>	<p>rovere corteccia invecchiato (opz.5382) bark aged oak (opt.5382)</p>	<p>rovere mielato invecchiato (opz.5383) honey aged oak (opt.5383)</p>	<p>rovere antracite invecchiato (opz.5384) anthracite aged oak (opt.5384)</p>	<p>rovere argilla invecchiato (opz.5385) clay aged oak (opt.5385)</p>
<p>rovere moro invecchiato (opz.5386) dark aged oak (opt.5386)</p>	<p>rovere naturale invecchiato parquettato (opz.5387) parquet-effect natural aged oak (opt.5387)</p>	<p>rovere madera termocotto (opz.5388) heat treated madera oak (opt.5388)</p>	<p>rovere grigio terra (opz.5389) grey earth oak (opt.5389)</p>		

## LACCATI OPACHI

MATT LACQUERED

<p>grigio traffico (opz.9511) traffic grey (opt.9511)</p>	<p>verde lichene (opz.8463) lichen green (opt.8463)</p>	<p>creta (opz.9515) clay (opt.9515)</p>	<p>bianco caldo (opz.7401) warm white (opt.7401)</p>	<p>fumo (opz.9531) smoke (opt.9531)</p>	<p>nero (opz.7892) black (opt.7892)</p>
<p>conchiglia (opz.7403) shell (opt.7403)</p>	<p>argilla (opz.9503) clay (opt.9503)</p>	<p>castoro (opz.8907) beaver (opt.8907)</p>	<p>bistro (opz.9535) bistro (opt.9535)</p>	<p>terra di siena (opz.8161) siena earth (opt.8161)</p>	<p>blu fiordaliso (opz.8377) cornflower blue (opt.8377)</p>
<p>grigio bromo (opz.9533) bromine grey (opt.9533)</p>	<p>grigio kenya (opz.9501) kenya grey (opt.9501)</p>	<p>verde positano (opz.8471) positano green (opt.8471)</p>	<p>giallo ambra (opz.327S) amber yellow (opt.327S)</p>	<p>rosso toscano (opz.8157) tuscan red (opt.8157)</p>	<p>lino (opz.9513) linen (opt.9513)</p>





# STRUTTURA A PARETE TOWER HI-LINE ESEMPIO DI COMPOSIZIONE

TOWER HI-LINE WALL MOUNTED STRUCTURE COMPOSITION EXAMPLE

ESEMPIO COMPOSIZIONE COLORE NERO L 197  
 EXAMPLE OF COMPOSITION BLACK FINISH L 197

DESCRIZIONE / DESCRIPTION		
<b>N°1 struttura a parete L 90 H 300 P 5</b> N°1 wall mounted structure W 90 H 300 D 5		
<b>N°1 montante a parete L 90 H 300 P 5</b> N°1 wall mounted pillar W 90 H 300 D 5		
<b>N°4 mensole in alluminio L 90 P 35</b> N°4 aluminim shelves W 90 D 35		
<b>N°4 mensole laccate a parete L 90 P 35</b> N°4 lacquered shelves wall mounting W 90 D 35		
<b>N°2 pensili laccati a ribalta tip-on L 90 H 36 P 33,4</b> N°2 lacquered wall units flap door opening W 90 H 36 D 33,4		

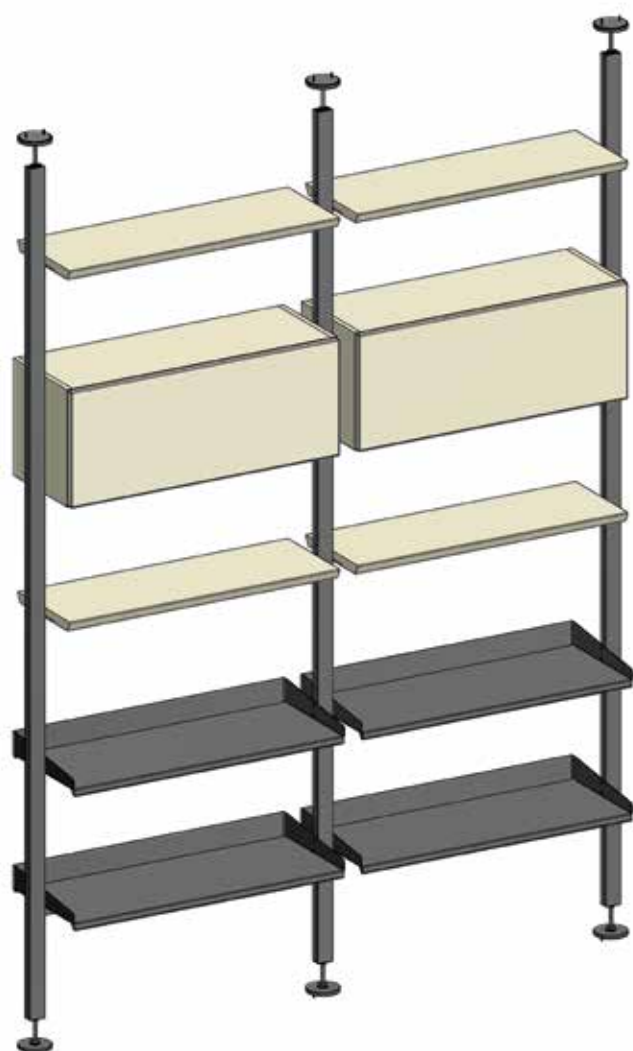

Vista frontale  
Front view

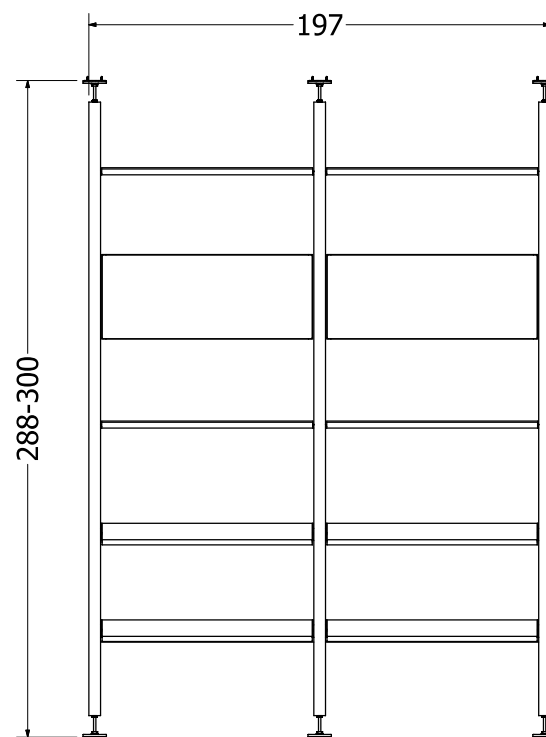

Vista superiore  
Top view

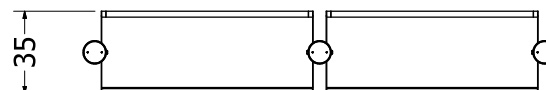

# STRUTTURA AD ISOLA TOWER HI-LINE ESEMPIO DI COMPOSIZIONE

TOWER HI-LINE ISLAND STRUCTURE COMPOSITION EXAMPLE

ESEMPIO COMPOSIZIONE COLORE NERO L 233  
 EXAMPLE OF COMPOSITION BLACK FINISH

DESCRIZIONE / DESCRIPTION		
<b>N°1 struttura ad isola L 60 H 270 P 5</b> N°1 metal island structure W 60 H 270 D 5		
<b>N°1 montante ad isola L 90 H 270 P 5</b> N°1 metal island pillar W 90 H 270 D 5		
<b>N°1 montante ad isola L 60 H 270 P 5</b> N°1 metal island pillar W 60 H 270 D 5		
<b>N°4 mensole in alluminio L 60 P 35</b> N°4 alumium shelves W 60 D 35		
<b>N°2 mensole in alluminio L 90 P 35</b> N°2 alumium shelves W 90 D 35		
<b>N°6 mensole impialacciate isola L 60 P 35</b> N°6 veneered shelves for island W 60 D 35		
<b>N°2 mensole impialacciate isola L 90 P 35</b> N°2 veneered shelves for island W 90 D 35		

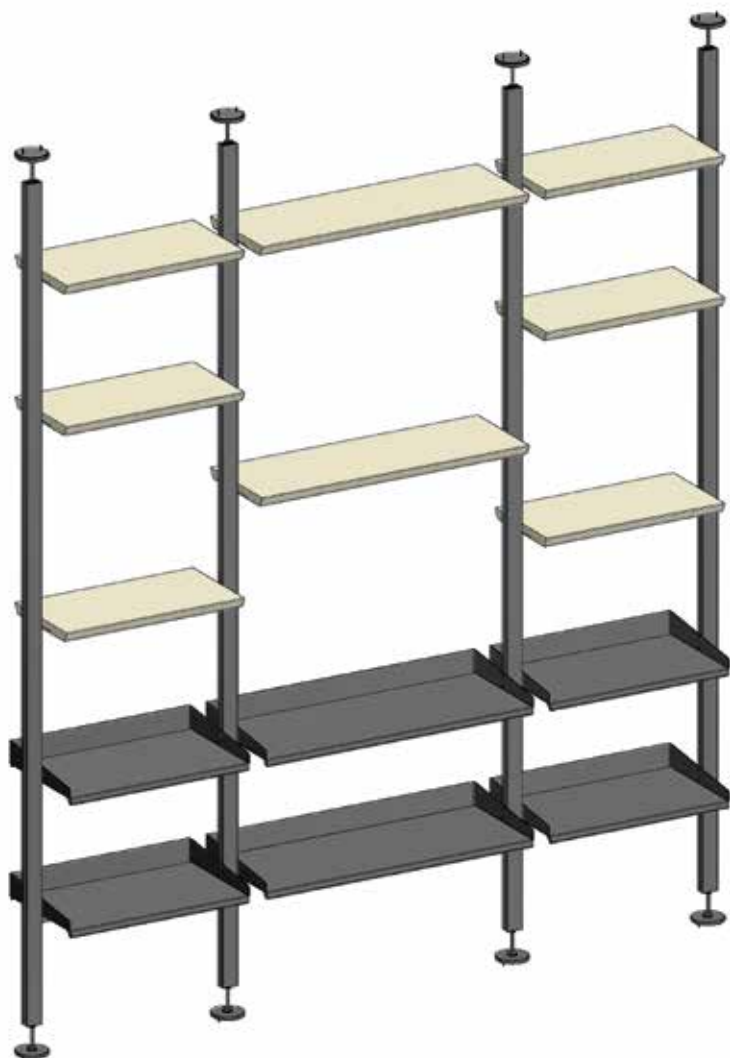

Vista frontale  
Front view

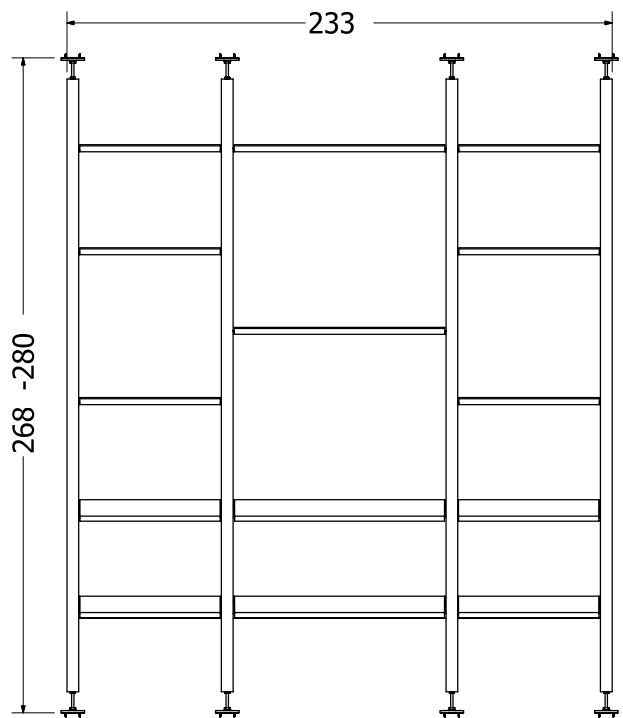

Vista superiore  
Top view

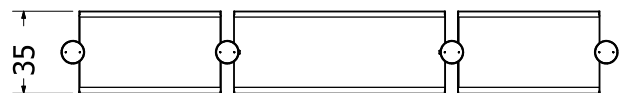

## COMPOSIZIONE L 423

COMPOSITION W 423



## COMPOSIZIONE L 420

COMPOSITION W 420



## COMPOSIZIONE L 423

COMPOSITION W 423

### COMPONENTI COMPONENTS

**Colonna 60 H 222 frigo-freezer 315 classe A+**

60 cm column H 222 fridge-freezer 315 class "A+"

**Colonna 60 H 222 forno multifunzione inox**

60 cm column H 222 for stainless steel multifunctional oven

**Base 60**

60 cm base unit

**Piano cottura 75 5 gas inox con valvola**

75 cm stainless steel hob with 5 burners with safety valve

**Base 90 2 cassetti e cestone predisposta piano cottura**

90 cm base unit with 2 drawers and deep drawers configured for hob

**Base 60**

60 cm base unit

**Sottolavello 90**

90 cm sink unit

**Lavello ad incasso 86 x 50 1 vasca inox**

86x50 cm built-in sink with 1 stainless steel bowl

**Top 300 P 61 in laminato H 4**

300 cm laminate worktop D 61 H 4

**Pensile 60 H 72**

60 cm wall unit H 72

**Cappa 90 "STILO" inox**

90 cm "STILO" stainless steel hood

**Pensile 60 H 72**

60 cm wall unit H 72

**Scolapiatti 90 H 72**

90 cm plate rack H 72

**Asta appendipensili ml 4**

4 lm wall unit fixing strip

**(Elettrodomestici Hotpoint)**  
(Hotpoint appliances)

### NECK

### VERSIONI VERSIONS

Impiallacciata Veneered

Fenix

Laccato Opaco Matt Lacquered

Laccato Lucido Glossy Lacquered

Laccato Vintage Vintage Lacquered

Vetro Satinato Satin Glass

Vetro Lucido Glossy Glass

### LUX

Impiallacciata Veneered

Fenix

Laccato Opaco Matt Lacquered

Laccato Lucido Glossy Lacquered

Laccato Vintage Vintage Lacquered

Vetro Satinato Satin Glass

Vetro Lucido Glossy Glass

## COMPOSIZIONE L 420

COMPOSITION W 420

### COMPONENTI COMPONENTS

**Colonna 60 H 222 frigo-freezer 315 classe A+**

60 cm column H 222 fridge-freezer 315 class "A+"

**Colonna 60 H 222 forno multifunzione inox**

60 cm column H 222 for stainless steel multifunctional oven

**Base 60**

60 cm base unit

**Piano cottura 75 5 gas inox con valvola**

75 cm stainless steel hob with 5 burners with safety valve

**Base 90 2 cassetti e cestone predisposta piano cottura**

90 cm base unit with 2 drawers and deep drawers configured for hob

**Base 60**

60 cm base unit

**Sottolavello 90**

90 cm sink unit

**Lavello ad incasso 86 x 50 1 vasca inox**

86x50 cm built-in sink with 1 stainless steel bowl

**Top 300 P 61 in laminato H 4**

300 cm laminate worktop D 61 H 4

**Pensile 60 H 72**

60 cm wall unit H 72

**Cappa 90 "STILO" inox**

90 cm "STILO" stainless steel hood

**Pensile 60 H 72**

60 cm wall unit H 72

**Scolapiatti 90 H 72**

90 cm plate rack H 72

**Asta appendipensili ml 4**

4 lm wall unit fixing strip

**(Elettrodomestici Hotpoint)**  
(Hotpoint appliances)

### VERSIONI VERSIONS

### BRIDGE

Impiallacciata Veneered

Fenix

Laccato Opaco Matt Lacquered

Laccato Lucido Glossy Lacquered

Laccato Vintage Vintage Lacquered