

PROVENZA



*‘Quando il Vintage
diviene
Contemporaneo...’*

*‘when vintage
becomes
contemporary...’*

Il nuovo modello **Provenza** interpreta lo stile Vintage declinato in soluzioni arredative dallo spirito contemporaneo. Il legno pregiato delle ante, a pannello pieno o dogato, i dettagli accurati e gli accessori sono modulati sapientemente per conferire al progetto una bellezza fatta di stile e qualità. Il legno è proposto con una laccatura a poro chiuso, con un effetto Shabby, che aggiunge preziosità all’insieme.

Our new **Provence** model recreates vintage style giving a wide range of décor solutions with a contemporary spirit. The exquisite wooden doors with either solid or slatted panels, delicate details and carefully selected accessories all give the collection a style which abounds in both beauty and quality. The wood has been finished with a closed-pore lacquer and a Shabby effect which makes it irresistibly charming.

SP. 22 MM**laccata a telaio e telaio con doghe****CARATTERISTICHE TECNICHE****ANTE E FRONTALI
CASSETTI LACCATI
A TELAIO**

anta a telaio con bugna sp.22 mm in mdf laccata finitura opaca soft antigraffio (conforme [US EPA TSCA Title VI](#)) nei colori caldi: bianco conchiglia (opz.W720), mandorla (opz.W820), lino (opz.W770), coloniale (opz.W870), carbon (opz.W920)

**ANTE CON BUGNA
LAVAGNA**

disponibili nelle ante pensile e colonna: 68x56 - 68,7x59 - 68x86 - 200x59 nei colori: bianco conchiglia (opz.W720), mandorla (opz.W820), lino (opz.W770), coloniale (opz.W870), carbon (opz.W920)

**ANTE TELAIO
A DOGHE**

anta a telaio con bugna dogata sp.22 mm in mdf laccata finitura opaca soft anti graffio nei colori caldi: bianco conchiglia (opz.W720), mandorla (opz.W820), lino (opz.W770), coloniale (opz.W870), carbon (opz.W920)

N.B.: disponibile solo per basi e ante inferiori delle colonne L 45 - L 60 - L 63 - L 90

ANTE VETRO

di serie: VETRO EXTRA CHIARO TRASPARENTE SP.4 MM

telaio sp.22 mm in mdf laccata finitura opaca soft anti graffio nei colori caldi
bianco conchiglia (opz.W720), mandorla (opz.W820), lino (opz.W770), coloniale (opz.W870), carbon (opz.W920)

a richiesta: VETRO BRONZATO SP.4 MM O SATINATO BIANCO SP.4 MM

telaio sp.22 mm in mdf laccata finitura opaca soft anti graffio nei colori caldi
bianco conchiglia (opz.W720), mandorla (opz.W820), lino (opz.W770), coloniale (opz.W870), carbon (opz.W920)

**ANTE VETRO
CON INGLESINA
TIPO "A"**

di serie: VETRO EXTRA CHIARO TRASPARENTE SP.4 MM CON INGLESINA TIPO "A" COLORE GRAFITE

telaio sp.22 mm in mdf laccata finitura opaca soft anti graffio nei colori caldi
bianco conchiglia (opz.W720A), mandorla (opz.W820A), lino (opz.W770A), coloniale (opz.W870A), carbon (opz.W920A)

a richiesta: VETRO BRONZATO SP.4 MM O SATINATO BIANCO SP.4 MM CON INGLESINA TIPO "A" COLORE GRAFITE

telaio sp.22 mm in mdf laccata finitura opaca soft anti graffio nei colori caldi
bianco conchiglia (opz.W720A), mandorla (opz.W820A), lino (opz.W770A), coloniale (opz.W870A), carbon (opz.W920A)

**ANTE VETRO
CON INGLESINA
TIPO "B"**

di serie: VETRO EXTRA CHIARO TRASPARENTE SP.4 MM CON INGLESINA TIPO "B" COLORE GRAFITE

telaio sp.22 mm in mdf laccata finitura opaca soft anti graffio nei colori caldi
bianco conchiglia (opz.W720B), mandorla (opz.W820B), lino (opz.W770B), coloniale (opz.W870B), carbon (opz.W920B)

a richiesta: VETRO BRONZATO SP.4 MM O SATINATO BIANCO SP.4 MM CON INGLESINA TIPO "B" COLORE GRAFITE

telaio sp.22 mm in mdf laccata finitura opaca soft anti graffio nei colori caldi
bianco conchiglia (opz.W720B), mandorla (opz.W820B), lino (opz.W770B), coloniale (opz.W870B), carbon (opz.W920B)

N.B.: per gli abbinamenti dei colori delle ante vetro con inglesina vedi pag.30

MANIGLIE

di serie: W50 finitura nichel satinato passo mm 64/160/320 in funzione dell'anta

a richiesta:

W51 finitura verniciato brunito passo mm 64/160/320 in funzione dell'anta

W583 finitura nichel satinato passo mm 16/160 in funzione dell'anta

W30 finitura black satinato passo mm 16/160 in funzione dell'anta

K82 finitura nichel satinato passo mm 128

per anta L 15 pomo passo mm 32 finitura nichel satinato K82P

K82G finitura ghisa passo mm 128

per anta L 15 pomo passo mm 32 finitura ghisa K82GP

W01 finitura nichel satinato passo mm 128

574 finitura acciaio ossidato brown passo mm 16/160/320 in funzione dell'anta

W52 finitura verniciato bronzo passo mm 160/320 in funzione dell'anta

W60 finitura nichel black satinato passo mm 96/160/320 in funzione dell'anta

W10 finitura verniciato brunito passo mm 64/96 in funzione dell'anta

W11 finitura peltro passo mm 64/96 in funzione dell'anta

W 90 ad incasso finitura nichel satinato passo mm 64/128 in funzione dell'anta



CARATTERISTICHE TECNICHE

STRUTTURE

ANTE: bianco conchiglia, coloniale

multistrato sp.25 mm bilaminato bianco perla (opz.W700), bordo bianco conchiglia (opz.W720)
 ripiano multistrato sp.25 mm bilaminato bianco perla (opz.W700),
 schiena in polipropilene bianco (opz.001)

ANTA: mandorla

multistrato sp.25 mm bilaminato juta (opz.W800), bordo mandorla (opz.W820)
 ripiano multistrato sp.25 mm bilaminato juta (opz.W800),
 schiena in polipropilene visone (opz.948M)

ANTA: lino

multistrato sp.25 mm bilaminato cenere (opz.W750), bordo lino (opz.W770)
 ripiano multistrato sp.25 mm bilaminato cenere (opz.W750),
 schiena in polipropilene bianco (opz.001)

ANTA: carbon

multistrato sp.25 mm bilaminato carbon (opz.W900), bordo carbon (opz.W920)
 ripiano multistrato sp.25 mm bilaminato carbon (opz.W900),
 schiena in polipropilene lavagna (opz.9620)

MENSOLE

di serie: altezza 40 mm listellare laminato nei colori: bianco perla (opz.W700), juta (opz.W800), cenere (opz.W750),
 carbon (opz.W900)

a richiesta: altezza 40 mm in listellare laccato nei colori:

bianco conchiglia (opz.W720), mandorla (opz.W820), lino (opz.W770), coloniale (opz.W870), carbon (opz.W920)

ZOCCOLI

di serie: altezza cm 13 in pvc in alluminio satinato (opz.405)

a richiesta: altezza cm 13 in alluminio liscio finitura brill (opz.412) e alluminio titanio (opz.414), vedi maggiorazione pag.35

altezza cm 13 in alluminio laccato nei colori: bianco conchiglia (opz.W720), mandorla (opz.W820), lino (opz.W770),
 carbon (opz.W920), vedi maggiorazione pag. 35

I PRODOTTI IN LEGNO SONO CONFORMI AL REGOLAMENTO (US EPA TSCA Title VI) RIGUARDO ALL'EMISSIONE DI FORMALDEIDE



TH. 22 MM

lacquered framed and frame with slats

TECHNICAL FEATURES

DOORS AND DRAWER FRONT PANELS FRAMED AND LACQUERED	framed door with raised panel 22 mm thick in lacquered mdf anti-scratch soft matt finish (compliant with US EPA TSCA Title VI) in the following warm colours: shell white (opt.W720), almond (opt.W820), linen (opt.W770), colonial (opt.W870), carbon (opt.W920)
DOORS WITH BLACKBOARD PANEL	available in wall unit and column doors: 68x56 - 68,7x59 - 68x86 - 200x59 in the following colours: shell white (opt.W720), almond (opt.W820), linen (opt.W770), colonial (opt.W870), carbon (opt.W920)
DOORS PANELS SLATTED FRAME	framed door with slatted raised panel 22 mm thick in lacquered mdf anti-scratch soft matt finish in the following warm colours: shell white (opt.W720), almond (opt.W820), linen (opt.W770), colonial (opt.W870), carbon (opt.W920) <i>Note: only available for base units and lower doors of columns W 45 - W 60 - W 63 - W 90</i>
GLASS DOORS	<p>standard: 4 MM TH. EXTRA LIGHT CLEAR GLASS frame 22 mm thick in lacquered mdf anti-scratch soft matt finish in the following warm colours: shell white (opt.W720), almond (opt.W820), linen (opt.W770), colonial (opt.W870), carbon (opt.W920)</p> <p>on request: 4 MM TH. BRONZED GLASS OR 4 MM TH. WHITE FROSTED GLASS frame 22 mm thick in lacquered mdf anti-scratch soft matt finish in the following warm colours: shell white (opt.W720), almond (opt.W820), linen (opt.W770), colonial (opt.W870), carbon (opt.W920)</p>
GLASS DOORS WITH MULLION ACCENTS TYPE "A"	<p>standard: 4 MM TH. EXTRA LIGHT CLEAR GLASS WITH TYPE "A" MULLION ACCENTS GRAPHITE COLOUR frame 22 mm thick in lacquered mdf anti-scratch soft matt finish in the following warm colours: shell white (opt.W720A), almond (opt.W820A), linen (opt.W770A), colonial (opt.W870A), carbon (opt.W920A)</p> <p>on request: 4 MM TH. BRONZED GLASS OR 4 MM TH. WHITE FROSTED GLASS WITH TYPE "A" MULLION ACCENTS GRAPHITE COLOUR frame 22 mm thick in lacquered mdf anti-scratch soft matt finish in the following warm colours: shell white (opt.W720A), almond (opt.W820A), linen (opt.W770A), colonial (opt.W870A), carbon (opt.W920A)</p>
GLASS DOORS WITH MULLION ACCENTS TYPE "B"	<p>standard: 4 MM TH. EXTRA LIGHT CLEAR GLASS WITH TYPE "B" MULLION ACCENTS GRAPHITE COLOUR frame 22 mm thick in lacquered mdf anti-scratch soft matt finish in the following warm colours: shell white (opt.W720B), almond (opt.W820B), linen (opt.W770B), colonial (opt.W870B), carbon (opt.W920B)</p> <p>on request: 4 MM TH. BRONZED GLASS OR 4 MM TH. WHITE FROSTED GLASS WITH TYPE "B" MULLION ACCENTS GRAPHITE COLOUR frame 22 mm thick in lacquered mdf anti-scratch soft matt finish in the following warm colours: shell white (opt.W720B), almond (opt.W820B), linen (opt.W770B), colonial (opt.W870B), carbon (opt.W920B)</p> <p><i>Note: for the colours combinations of the glass doors with mullion accents, see pag.30</i></p>
HANDLES	<p>standard: W50 satin nickel finish, 64/160/320 centre-to-centre distance depending on the door</p> <p>on request: W51 burnished painted finish, 64/160/320 mm centre-to-centre distance depending on the door W583 satin nickel finish, 16/160 centre-to-centre distance according to door size W30 satin black finish, 16/160 centre-to-centre distance according to door size K82 satin nickel finish, 128 mm centre-to-centre distance for door W 15 satin-finish nickel knob hole K82P 32 mm centre-to-centre distance K82G cast iron finish, 128 mm centre-to-centre distance for door W 15 cast iron finish knob hole K82GP 32 mm centre-to-centre distance W01 satin nickel finish, 128 mm centre-to-centre distance 574 brown rusted steel finish, 16/160/320 centre-to-centre distance depending on the door W52 painted bronze finish, 160/320 mm centre-to-centre distance W60 black satin nickel finish, 96/160/320 centre-to-centre distance depending on the door W10 painted burnished finish, 64/96 mm centre-to-centre distance W11 pewter finish, 64/96 mm centre-to-centre distance W 90 recessed satin nickel finish, 64/128 centre-to-centre distance according to door size</p>



TECHNICAL FEATURES

CARCASSES

DOORS: shell white, colonial

25 mm th. two-sided laminated plywood in pearl white (opt.W700), shell white edge (opt.W720)
 25 mm th. two-sided laminated plywood shelf in pearl white (opt.W700),
 white polypropylene back panel (opt.001)

DOOR: almond

25 mm th. two-sided laminated plywood in jute (opt.W800), almond edge (opt.W820)
 25 mm th. two-sided laminated plywood shelf in jute (opt.W800),
 mink polypropylene back panel (opt.948M)

DOOR: linen

25 mm th. two-sided laminated plywood in ash (opt.W750), linen edge (opt.W770)
 25 mm th. two-sided laminated plywood shelf in ash (opt.W750),
 white polypropylene back panel (opt.001)

DOOR: carbon

25 mm th. two-sided laminated plywood in carbon (opt.W900), carbon edge (opt.W920)
 25 mm th. two-sided laminated plywood shelf in carbon (opt.W900),
 slate grey polypropylene back panel (opt.9620)

SHELVES

standard: height 40 mm laminated blockboard in the following colours: pearl white (opt.W700), jute (opt.W800), ash (opt.W750),
 carbon (opt.W900)

on request: height 40 mm lacquered blockboard in the following colours:

shell white (opt.W720), almond (opt.W820), linen (opt.W770), colonial (opt.W870), carbon (opt.W920)

PLINTHS

standard: height 13 cm, in PVC with satin-finish aluminium finish (opt.405)

on request: height 13 cm, in smooth aluminium with brill finish (opt.412), and titanium aluminium (opt.414), see surcharges on page 35

height 13 cm, in lacquered aluminium in the following colours: shell white (opt.W720), almond (opt.W820), linen (opt.W770),
 carbon (opt.W920), see surcharges on page 35

WOODEN PRODUCTS ARE COMPLIANT WITH REGULATIONS (US EPA TSCA Title VI) GOVERNING FORMALDEHYDE EMISSIONS



SP. 22 MM / TH. 22 MM

laccata a telaio
lacquered framed

ante
doors



anta bianco conchiglia
(opz.W720)
shell white door
(opt.W720)



frontale cassetto
drawer front panel



frontale cestone
deep drawer front panel



anta lavagna
nei colori laccati:
(opz.W720), (opz.W820), (opz.W770),
(opz.W870), (opz.W920)
door blackboard
lacquered colours:
opt.W720), (opt.W820), (opt.W770),
(opt.W870), (opt.W920)



anta lino (opz.W770)
linen door (opt.W770)



frontale cassetto
drawer front panel



frontale cestone
deep drawer front panel



anta mandorla (opz.W820)
almond door (opt.W820)



frontale cassetto
drawer front panel



frontale cestone
deep drawer front panel



anta carbon (opz.W920)
carbon door (opt.W920)



frontale cassetto
drawer front panel



frontale cestone
deep drawer front panel



anta coloniale (opz.W870)
colonial door (opt.W870)



frontale cassetto
drawer front panel



frontale cestone
deep drawer front panel

cod. **VP1**

PROVENZA

SP. 22 MM / TH. 22 MM

laccata telaio con doghe
lacquered frame with slats

ante
doors

N.B.: disponibile solo per basi e ante inferiori delle colonne L 45 - L 60 - L 63 - L 90
Note: only available for base units and lower doors of columns W 45 - W 60 - W 63 - W 90



anta bianco conchiglia (opz.W720D)
shell white door (opt.W720D)



frontale cestone
deep drawer front panel



anta mandorla (opz.W820D)
almond door (opt.W820D)



frontale cestone
deep drawer front panel



anta lino (opz.W770D)
linen door (opt.W770D)



frontale cestone
deep drawer front panel



anta coloniale (opz.W870D)
colonial door (opt.W870D)



frontale cestone
deep drawer front panel



anta carbon (opz.W920D)
carbon door (opt.W920D)



frontale cestone
deep drawer front panel

SP. 22 MM**laccata liscia****CARATTERISTICHE TECNICHE****ANTE E FRONTALI
CASSETTI**

anta liscia sp.22 mm in mdf laccata finitura opaca soft antigraffio (conforme [US EPA TSCA Title VI](#)) nei colori caldi: bianco conchiglia (opz.W720), mandorla (opz.W820), lino (opz.W770), coloniale (opz.W870), carbon (opz.W920)

ANTE VETRO

di serie: VETRO EXTRA CHIARO TRASPARENTE SP.4 MM

telaio sp.22 mm in mdf laccata finitura opaca soft anti graffio nei colori caldi
bianco conchiglia (opz.W720), mandorla (opz.W820), lino (opz.W770), coloniale (opz.W870), carbon (opz.W920)

a richiesta: VETRO BRONZATO SP.4 MM O SATINATO BIANCO SP.4 MM

telaio sp.22 mm in mdf laccata finitura opaca soft anti graffio nei colori caldi
bianco conchiglia (opz.W720), mandorla (opz.W820), lino (opz.W770), coloniale (opz.W870), carbon (opz.W920)

**ANTE VETRO
CON INGLESINA
TIPO "A"**

di serie: VETRO EXTRA CHIARO TRASPARENTE SP.4 MM CON INGLESINA TIPO "A" COLORE GRAFITE

telaio sp.22 mm in mdf laccata finitura opaca soft anti graffio nei colori caldi
bianco conchiglia (opz.W720A), mandorla (opz.W820A), lino (opz.W770A), coloniale (opz.W870A), carbon (opz.W920A)

a richiesta: VETRO BRONZATO SP.4 MM O SATINATO BIANCO SP.4 MM CON INGLESINA TIPO "A" COLORE GRAFITE

telaio sp.22 mm in mdf laccata finitura opaca soft anti graffio nei colori caldi
bianco conchiglia (opz.W720A), mandorla (opz.W820A), lino (opz.W770A), coloniale (opz.W870A), carbon (opz.W920A)

**ANTE VETRO
CON INGLESINA
TIPO "B"**

di serie: VETRO EXTRA CHIARO TRASPARENTE SP.4 MM CON INGLESINA TIPO "B" COLORE GRAFITE

telaio sp.22 mm in mdf laccata finitura opaca soft anti graffio nei colori caldi
bianco conchiglia (opz.W720B), mandorla (opz.W820B), lino (opz.W770B), coloniale (opz.W870B), carbon (opz.W920B)

a richiesta: VETRO BRONZATO SP.4 MM O SATINATO BIANCO SP.4 MM CON INGLESINA TIPO "B" COLORE GRAFITE

telaio sp.22 mm in mdf laccata finitura opaca soft anti graffio nei colori caldi
bianco conchiglia (opz.W720B), mandorla (opz.W820B), lino (opz.W770B), coloniale (opz.W870B), carbon (opz.W920B)

N.B.: per gli abbinamenti dei colori delle ante vetro con inglesina vedi pag.30

MANIGLIE

di serie: W50 finitura nichel satinato passo mm 64/160/320 in funzione dell'anta

a richiesta:

W51 finitura verniciato brunito passo mm 64/160/320 in funzione dell'anta

W583 finitura nichel satinato passo mm 16/160 in funzione dell'anta

W30 finitura black satinato passo mm 16/160 in funzione dell'anta

K82 finitura nichel satinato passo mm 128

per anta L 15 pomo passo mm 32 finitura nichel satinato K82P

K82G finitura ghisa passo mm 128

per anta L 15 pomo passo mm 32 finitura ghisa K82GP

W01 finitura nichel satinato passo mm 128

574 finitura acciaio ossidato brown passo mm 16/160/320 in funzione dell'anta

W52 finitura verniciato bronzo passo mm 160/320 in funzione dell'anta

W60 finitura nichel black satinato passo mm 96/160/320 in funzione dell'anta

W10 finitura verniciato brunito passo mm 64/96 in funzione dell'anta

W11 finitura peltro passo mm 64/96 in funzione dell'anta

W 90 ad incasso finitura nichel satinato passo mm 64/128 in funzione dell'anta



CARATTERISTICHE TECNICHE

STRUTTURE

ANTE: bianco conchiglia, coloniale

multistrato sp.25 mm bilaminato bianco perla (opz.W700), bordo bianco conchiglia (opz.W720)
 ripiano multistrato sp.25 mm bilaminato bianco perla (opz.W700),
 schiena in polipropilene bianco (opz.001)

ANTA: mandorla

multistrato sp.25 mm bilaminato juta (opz.W800), bordo mandorla (opz.W820)
 ripiano multistrato sp.25 mm bilaminato juta (opz.W800),
 schiena in polipropilene visone (opz.948M)

ANTA: lino

multistrato sp.25 mm bilaminato cenere (opz.W750), bordo lino (opz.W770)
 ripiano multistrato sp.25 mm bilaminato cenere (opz.W750),
 schiena in polipropilene bianco (opz.001)

ANTA: carbon

multistrato sp.25 mm bilaminato carbon (opz.W900), bordo carbon (opz.W920)
 ripiano multistrato sp.25 mm bilaminato carbon (opz.W900),
 schiena in polipropilene lavagna (opz.9620)

MENSOLE

di serie: altezza 40 mm listellare laminato nei colori: bianco perla (opz.W700), juta (opz.W800), cenere (opz.W750),
 carbon (opz.W900)

a richiesta: altezza 40 mm in listellare laccato nei colori:

bianco conchiglia (opz.W720), mandorla (opz.W820), lino (opz.W770), coloniale (opz.W870), carbon (opz.W920)

ZOCCOLI

di serie: altezza cm 13 in pvc in alluminio satinato (opz.405)

a richiesta: altezza cm 13 in alluminio liscio finitura brill (opz.412) e alluminio titanio (opz.414), vedi maggiorazione pag.35

altezza cm 13 in alluminio laccato nei colori: bianco conchiglia (opz.W720), mandorla (opz.W820), lino (opz.W770),
 carbon (opz.W920), vedi maggiorazione pag. 35

I PRODOTTI IN LEGNO SONO CONFORMI AL REGOLAMENTO (US EPA TSCA Title VI) RIGUARDO ALL'EMISSIONE DI FORMALDEIDE



TH. 22 MM

lacquered smooth

TECHNICAL FEATURES

DOORS AND DRAWER FRONTS smooth door 22 mm thick in lacquered mdf anti-scratch soft matt finish (compliant with [US EPA TSCA Title VI](#)) in the following warm colours: shell white (opt.W720), almond (opt.W820), linen (opt.W770), colonial (opt.W870), carbon (opt.W920)

GLASS DOORS
standard: 4 MM TH. EXTRA LIGHT CLEAR GLASS
 frame 22 mm thick in lacquered mdf anti-scratch soft matt finish in the following warm colours:
 shell white (opt.W720), almond (opt.W820), linen (opt.W770), colonial (opt.W870), carbon (opt.W920)

on request: 4 MM TH. BRONZED GLASS OR 4 MM TH. WHITE FROSTED GLASS
 frame 22 mm thick in lacquered mdf anti-scratch soft matt finish in the following warm colours:
 shell white (opt.W720), almond (opt.W820), linen (opt.W770), colonial (opt.W870), carbon (opt.W920)

GLASS DOORS WITH MULLION ACCENTS TYPE "A"
standard: 4 MM TH. EXTRA LIGHT CLEAR GLASS WITH TYPE "A" MULLION ACCENTS GRAPHITE COLOUR
 frame 22 mm thick in lacquered mdf anti-scratch soft matt finish in the following warm colours:
 shell white (opt.W720A), almond (opt.W820A), linen (opt.W770A), colonial (opt.W870A), carbon (opt.W920A)

on request: 4 MM TH. BRONZED GLASS OR 4 MM TH. WHITE FROSTED GLASS WITH TYPE "A" MULLION ACCENTS GRAPHITE COLOUR
 frame 22 mm thick in lacquered mdf anti-scratch soft matt finish in the following warm colours:
 shell white (opt.W720A), almond (opt.W820A), linen (opt.W770A), colonial (opt.W870A), carbon (opt.W920A)

GLASS DOORS WITH MULLION ACCENTS TYPE "B"
standard: 4 MM TH. EXTRA LIGHT CLEAR GLASS WITH TYPE "B" MULLION ACCENTS GRAPHITE COLOUR
 frame 22 mm thick in lacquered mdf anti-scratch soft matt finish in the following warm colours:
 shell white (opt.W720B), almond (opt.W820B), linen (opt.W770B), colonial (opt.W870B), carbon (opt.W920B)

on request: 4 MM TH. BRONZED GLASS OR 4 MM TH. WHITE FROSTED GLASS WITH TYPE "B" MULLION ACCENTS GRAPHITE COLOUR
 frame 22 mm thick in lacquered mdf anti-scratch soft matt finish in the following warm colours:
 shell white (opt.W720B), almond (opt.W820B), linen (opt.W770B), colonial (opt.W870B), carbon (opt.W920B)

Note: for the colours combinations of the glass doors with mullion accents, see pag.30

HANDLES **standard: W50 satin nickel finish, 64/160/320 centre-to-centre distance depending on the door**

on request:
 W51 burnished painted finish, 64/160/320 mm centre-to-centre distance depending on the door
 W583 satin nickel finish, 16/160 centre-to-centre distance according to door size
 W30 satin black finish, 16/160 centre-to-centre distance according to door size
 K82 satin nickel finish, 128 mm centre-to-centre distance
 for door W 15 satin-finish nickel knob hole K82P 32 mm centre-to-centre distance
 K82G cast iron finish, 128 mm centre-to-centre distance
 for door W 15 cast iron finish knob hole K82GP 32 mm centre-to-centre distance
 W01 satin nickel finish, 128 mm centre-to-centre distance
 574 brown rusted steel finish, 16/160/320 centre-to-centre distance depending on the door
 W52 painted bronze finish, 160/320 mm centre-to-centre distance
 W60 black satin nickel finish, 96/160/320 centre-to-centre distance depending on the door
 W10 painted burnished finish, 64/96 mm centre-to-centre distance
 W11 pewter finish, 64/96 mm centre-to-centre distance
 W 90 recessed satin nickel finish, 64/128 centre-to-centre distance according to door size



TECHNICAL FEATURES

CARCASSES

DOORS: shell white, colonial

25 mm th. two-sided laminated plywood in pearl white (opt.W700), shell white edge (opt.W720)
 25 mm th. two-sided laminated plywood shelf in pearl white (opt.W700),
 white polypropylene back panel (opt.001)

DOOR: almond

25 mm th. two-sided laminated plywood in jute (opt.W800), almond edge (opt.W820)
 25 mm th. two-sided laminated plywood shelf in jute (opt.W800),
 mink polypropylene back panel (opt.948M)

DOOR: linen

25 mm th. two-sided laminated plywood in ash (opt.W750), linen edge (opt.W770)
 25 mm th. two-sided laminated plywood shelf in ash (opt.W750),
 white polypropylene back panel (opt.001)

DOOR: carbon

25 mm th. two-sided laminated plywood in carbon (opt.W900), carbon edge (opt.W920)
 25 mm th. two-sided laminated plywood shelf in carbon (opt.W900),
 slate grey polypropylene back panel (opt.9620)

SHELVES

standard: height 40 mm laminated blockboard in the following colours: pearl white (opt.W700), jute (opt.W800), ash (opt.W750),
 carbon (opt.W900)

on request: height 40 mm lacquered blockboard in the following colours: shell white (opt.W720), almond (opt.W820),
 linen (opt.W770), colonial (opt.W870), carbon (opt.W920)

PLINTHS

standard: height 13 cm, in PVC with satin-finish aluminium finish (opt.405)

on request: height 13 cm, in smooth aluminium with brill finish (opt.412), and titanium aluminium (opt.414), see surcharges on page 35

height 13 cm, in lacquered aluminium in the following colours: shell white (opt.W720), almond (opt.W820), linen (opt.W770),
 carbon (opt.W920), see surcharges on page 35

WOODEN PRODUCTS ARE COMPLIANT WITH REGULATIONS (US EPA TSCA Title VI) GOVERNING FORMALDEHYDE EMISSIONS



SP. 22 MM / TH. 22 MM

laccata liscia
lacquered smooth

ante
doors



anta bianco conchiglia
(opz.W720)
shell white door
(opt.W720)



frontale cassetto
drawer front panel



frontale cestone
deep drawer front panel



anta mandorla (opz.W820)
almond door (opt.W820)



frontale cassetto
drawer front panel



frontale cestone
deep drawer front panel



anta lino (opz.W770)
linen door (opt.W770)



frontale cassetto
drawer front panel



frontale cestone
deep drawer front panel



anta coloniale (opz.W870)
colonial door (opt.W870)



frontale cassetto
drawer front panel



frontale cestone
deep drawer front panel



anta carbon (opz.W920)
carbon door (opt.W920)



frontale cassetto
drawer front panel



frontale cestone
deep drawer front panel



SP. 22 MM**impiallacciata telaio e telaio con doghe****CARATTERISTICHE TECNICHE****ANTE E FRONTALI
CASSETTI A TELAIO**

anta a telaio sp.22 mm in massello di rovere con bugna impiallacciata (conforme [US EPA TSCA Title VI](#)) nei colori: rovere mielato (opz.W520), rovere bianco (opz.W525), rovere grigio terra (opz.W530)
anta a telaio sp.22 mm in massello di noce yesquero con bugna impiallacciata nel colore: noce canaletto (opz.W120)

**ANTE CON BUGNA
LAVAGNA**

disponibili nelle ante pensile e colonna: 68x56 - 68,7x59 - 68x86 - 200x59 nei colori: rovere mielato (opz.W520), rovere bianco (opz.W525), rovere grigio terra (opz.W530), noce canaletto (opz.W120)

**ANTE TELAIO
CON DOGHE**

anta a telaio sp.22 mm in massello di rovere con bugna impiallacciata a doghe nei colori: rovere mielato (opz.W520), rovere bianco (opz.W525), rovere grigio terra (opz.W530)
anta a telaio sp.22 mm in massello di noce yesquero con bugna impiallacciata a doghe nel colore: noce canaletto (opz.W120)

N.B.: disponibile solo per basi e ante inferiori delle colonne L 45 - L 60 - L 63 - L 90

ANTE VETRO

di serie: VETRO EXTRA CHIARO TRASPARENTE SP.4 MM

telaio sp.22 mm in massello di rovere nei colori: rovere mielato (opz.W520), rovere bianco (opz.W525), rovere grigio terra (opz.W530)
telaio sp.22 mm in massello noce yesquero nel colore: noce canaletto (opz.W120)

a richiesta: VETRO BRONZATO SP.4 MM O SATINATO BIANCO SP.4 MM

telaio sp.22 mm in massello di rovere nei colori: rovere mielato (opz.W520), rovere bianco (opz.W525), rovere grigio terra (opz.W530)
telaio sp.22 mm in massello noce yesquero nel colore: noce canaletto (opz.W120)

**ANTE VETRO
CON INGLESINA**

di serie: VETRO EXTRA CHIARO TRASPARENTE SP.4 MM CON INGLESINA TIPO "A" COLORE GRAFITE

telaio sp.22 mm in massello di rovere nei colori: rovere mielato (opz.W520A), rovere bianco (opz.W525A), rovere grigio terra (opz.W530A)
telaio sp.22 mm in massello noce yesquero nel colore: noce canaletto (opz.W120A)

a richiesta: VETRO BRONZATO SP.4 MM O SATINATO BIANCO SP.4 MM CON INGLESINA TIPO "A" COLORE GRAFITE

telaio sp.22 mm in massello di rovere nei colori: rovere mielato (opz.W520A), rovere bianco (opz.W525A), rovere grigio terra (opz.W530A)
telaio sp.22 mm in massello noce yesquero nel colore: noce canaletto (opz.W120A)

MANIGLIE

di serie: W50 finitura nichel satinato passo mm 64/160/320 in funzione dell'anta

a richiesta:

W51 finitura verniciato brunito passo mm 64/160/320 in funzione dell'anta
W583 finitura nichel satinato passo mm 16/160 in funzione dell'anta
W30 finitura black satinato passo mm 16/160 in funzione dell'anta
K82 finitura nichel satinato passo mm 128
per anta L 15 pomo passo mm 32 finitura nichel satinato K82P
K82G finitura ghisa passo mm 128
per anta L 15 pomo passo mm 32 finitura ghisa K82GP
W01 finitura nichel satinato passo mm 128
574 finitura acciaio ossidato brown passo mm 16/160/320 in funzione dell'anta
W52 finitura verniciato bronzo passo mm 160/320 in funzione dell'anta
W60 finitura nichel black satinato passo mm 96/160/320 in funzione dell'anta
W10 finitura verniciato brunito passo mm 64/96 in funzione dell'anta
W11 finitura peltro passo mm 64/96 in funzione dell'anta
W 90 ad incasso finitura nichel satinato passo mm 64/128 in funzione dell'anta



CARATTERISTICHE TECNICHE

STRUTTURE

ANTA: rovere mielato

multistrato sp.25 mm bilaminato carbon (opz.W900), bordo carbon (opz.W920)
 ripiano multistrato sp.25 mm bilaminato carbon (opz.W900),
 schiena in polipropilene lavagna (opz.9620)

ANTA: rovere bianco

multistrato sp.25 mm bilaminato cenere (opz.W750), bordo lino (opz.W770)
 ripiano multistrato sp.25 mm bilaminato cenere (opz.W750),
 schiena in polipropilene bianco (opz.001)

ANTE: noce canaletto, rovere grigio terra

multistrato sp.25 mm bilaminato juta (opz.W800), bordo mandorla (opz.W820)
 ripiano multistrato sp.25 mm bilaminato juta (opz.W800),
 schiena in polipropilene visone (opz.948M)

MENSOLE

di serie: altezza 40 mm listellare laminato nei colori: bianco perla (opz.W700), juta (opz.W800), cenere (opz.W750), carbon (opz.W900)

a richiesta: altezza 40 mm listellare impiallacciato nei colori: rovere mielato (opz.W520), rovere bianco (opz.W525), noce canaletto (opz.W120), rovere grigio terra (opz.W530)

ZOCCOLI

di serie: altezza cm 13 in pvc in alluminio satinato (opz.405)

a richiesta: altezza cm 13 in alluminio liscio finitura brill (opz.412) e alluminio titanio (opz.414), vedi maggiorazione pag.35

altezza cm 13 in alluminio laccato nei colori: bianco conchiglia (opz.W720), mandorla (opz.W820), lino (opz.W770), carbon (opz.W920), vedi maggiorazione pag. 35

I PRODOTTI IN LEGNO SONO CONFORMI AL REGOLAMENTO (US EPA TSCA Title VI) RIGUARDO ALL'EMISSIONE DI FORMALDEIDE



TH. 22 MM

veneered frame and frame with slats

TECHNICAL FEATURES

DOORS AND DRAWER FRONT PANELS FRAMED framed door 22 mm th. in solid oak with veneered raised panel (compliant with [US EPA TSCA Title VI](#)) in the following colours: honey oak (opt.W520), white oak (opt.W525), earth grey oak (opt.W530)
framed door 22 mm th. in solid yesquero walnut with veneered raised panel in the following colour: canaletto walnut (opt.W120)

DOORS WITH BLACKBOARD PANEL available in wall unit and column doors: 68x56 - 68,7x59 - 68x86 - 200x59 in the following colours: honey oak (opt.W520), white oak (opt.W525), earth grey oak (opt.W530), canaletto walnut (opt.W120)

DOORS PANELS FRAMED WITH SLATS door with frame 22 mm th. in solid oak with veneered slatted raised panel in the following colours: honey oak (opt.W520), white oak (opt.W525), earth grey oak (opt.W530)
framed door 22 mm th. in solid yesquero walnut with veneered slatted raised panel in the following colour: canaletto walnut (opt.W120)

Note: only available for base units and lower doors of columns W 45 - W 60 - W 63 - W 90

GLASS DOORS **standard: 4 MM TH. EXTRA LIGHT CLEAR GLASS**
frame 22 mm th. in solid oak in the following colours: honey oak (opt.W520), white oak (opt.W525), earth grey oak (opt.W530)
frame 22 mm th. in solid yesquero walnut in the following colour: canaletto walnut (opt.W120)

on request: 4 MM TH. BRONZED GLASS OR 4 MM TH. WHITE FROSTED GLASS
frame 22 mm th. in solid oak in the following colours: honey oak (opt.W520), white oak (opt.W525), earth grey oak (opt.W530)
frame 22 mm th. in solid yesquero walnut in the following colour: canaletto walnut (opt.W120)

GLASS DOORS WITH MULLION ACCENTS **standard: 4 MM TH. EXTRA LIGHT CLEAR GLASS WITH TYPE "A" MULLION ACCENTS GRAPHITE COLOUR**
frame 22 mm th. in solid oak in the following colours: honey oak (opt.W520A), white oak (opt.W525A), earth grey oak (opt.W530A)
frame 22 mm th. in solid yesquero walnut in the following colour: canaletto walnut (opt.W120A)

on request: 4 MM TH. BRONZED GLASS OR 4 MM TH. WHITE FROSTED GLASS WITH TYPE "A" MULLION ACCENTS GRAPHITE COLOUR
frame 22 mm th. in solid oak in the following colours: honey oak (opt.W520A), white oak (opt.W525A), earth grey oak (opt.W530A)
frame 22 mm th. in solid yesquero walnut in the following colour: canaletto walnut (opt.W120A)

HANDLES **standard: W50 satin nickel finish, 64/160/320 centre-to-centre distance depending on the door**

on request:
W51 burnished painted finish, 64/160/320 mm centre-to-centre distance depending on the door
W583 satin nickel finish, 16/160 centre-to-centre distance according to door size
W30 satin black finish, 16/160 centre-to-centre distance according to door size
K82 satin nickel finish, 128 mm centre-to-centre distance
for door W 15 satin-finish nickel knob hole K82P 32 mm centre-to-centre distance
K82G cast iron finish, 128 mm centre-to-centre distance
for door W 15 cast iron finish knob hole K82GP 32 mm centre-to-centre distance
W01 satin nickel finish, 128 mm centre-to-centre distance
574 brown rusted steel finish, 16/160/320 centre-to-centre distance depending on the door
W52 painted bronze finish, 160/320 mm centre-to-centre distance
W60 black satin nickel finish, 96/160/320 centre-to-centre distance depending on the door
W10 painted burnished finish, 64/96 mm centre-to-centre distance
W11 pewter finish, 64/96 mm centre-to-centre distance
W 90 recessed satin nickel finish, 64/128 centre-to-centre distance according to door size



TECHNICAL FEATURES

CARCASSES

DOOR: honey oak

25 mm th. two-sided laminated plywood in carbon (opt.W900), carbon edge (opt.W920)
 25 mm th. two-sided laminated plywood shelf in carbon (opt.W900),
 slate grey polypropylene back panel (opt.9620)

DOOR: white oak

25 mm th. two-sided laminated plywood in ash (opt.W750), linen edge (opt.W770)
 25 mm th. two-sided laminated plywood shelf in ash (opt.W750),
 white polypropylene back panel (opt.001)

DOORS: canaletto walnut, earth grey oak

25 mm th. two-sided laminated plywood in jute (opt.W800), almond edge (opt.W820)
 25 mm th. two-sided laminated plywood shelf in jute (opt.W800),
 mink polypropylene back panel (opt.948M)

SHELVES

standard: height 40 mm laminated blockboard in the following colours: pearl white (opt.W700), jute (opt.W800), ash (opt.W750),
 carbon (opt.W900)

on request: height 40 mm veneered blockboard in the following colours: honey oak (opt.W520), white oak (opt.W525),
 canaletto walnut (opt.W120), earth grey oak (opt.W530)

PLINTHS

standard: height 13 cm, in PVC with satin-finish aluminium finish (opt.405)

on request: height 13 cm, in smooth aluminium with brill finish (opt.412), and titanium aluminium (opt.414), see surcharges on page 35

height 13 cm, in lacquered aluminium in the following colours: shell white (opt.W720), almond (opt.W820), linen (opt.W770),
 carbon (opt.W920), see surcharges on page 35

WOODEN PRODUCTS ARE COMPLIANT WITH REGULATIONS (US EPA TSCA Title VI) GOVERNING FORMALDEHYDE EMISSIONS



SP. 22 MM / TH. 22 MM

impiallacciata telaio
veneered frame

ante
doors



anta rovere mielato
(opz.W520)
honey oak door
(opt.W520)



frontale cassetto
drawer front panel



frontale cestone
deep drawer front panel



anta lavagna
nei colori impiallacciati:
(opz.W520), (opz.W530),
(opz.W525), (opz.W120)
door blackboard
veneered colours:
(opt.W520), (opt.W530),
(opt.W525), (opt.W120)



anta rovere bianco
(opz.W525)
white oak door
(opt.W525)



frontale cassetto
drawer front panel



frontale cestone
deep drawer front panel



anta rovere grigio terra
(opz.W530)
earth grey oak door
(opt.W530)



frontale cassetto
drawer front panel



frontale cestone
deep drawer front panel



anta noce canaletto
(opz.W120)
canaletto walnut door
(opt.W120)



frontale cassetto
drawer front panel



frontale cestone
deep drawer front panel

SP. 22 MM / TH. 22 MM

impiallacciata telaio con doghe
veneered frame with slats

ante
doors

N.B.: disponibile solo per basi e ante inferiori delle colonne L 45 - L 60 - L 63 - L 90
Note: only available for base units and lower doors of columns W 45 - W 60 - W 63 - W 90



anta rovere mielato
(opz.W520D)
honey oak door
(opt.W520D)



frontale cestone
deep drawer front panel



anta rovere grigio terra
(opz.W530D)
earth grey oak door
(opt.W530D)



frontale cestone
deep drawer front panel



anta rovere bianco
(opz.W525D)
white oak door
(opt.W525D)



frontale cestone
deep drawer front panel



anta noce canaletto
(opz.W120D)
canaletto walnut door
(opt.W120D)



frontale cestone
deep drawer front panel

SP. 22 MM**impiallacciata liscia****CARATTERISTICHE TECNICHE****ANTE E FRONTALI
CASSETTI**

anta liscia sp.22 mm in truciolare massellato impiallacciato rovere (conforme [US EPA TSCA Title VI](#)) nei colori:
 rovere mielato (opz.W520), rovere bianco (opz.W525), rovere grigio terra (opz.W530)

anta liscia sp.22 mm in truciolare massellato impiallacciato noce canaletto nel colore: noce canaletto (opz.W120)

ANTE VETRO

di serie: VETRO EXTRA CHIARO TRASPARENTE SP.4 MM

telaio sp.22 mm in massello di rovere nei colori: rovere mielato (opz.W520), rovere bianco (opz.W525), rovere grigio terra (opz.W530)

telaio sp.22 mm in massello noce canaletto nel colore: noce canaletto (opz.W120)

a richiesta: VETRO BRONZATO SP.4 MM O SATINATO BIANCO SP.4 MM

telaio sp.22 mm in massello di rovere nei colori: rovere mielato (opz.W520), rovere bianco (opz.W525), rovere grigio terra (opz.W530)

telaio sp.22 mm in massello noce canaletto nel colore: noce canaletto (opz.W120)

**ANTE VETRO
CON INGLESINA**

di serie: VETRO EXTRA CHIARO TRASPARENTE SP.4 MM CON INGLESINA TIPO "A" COLORE GRAFITE

telaio sp.22 mm in massello di rovere nei colori: rovere mielato (opz.W520A), rovere bianco (opz.W525A), rovere grigio terra (opz.W530A)

telaio sp.22 mm in massello noce canaletto nel colore: noce canaletto (opz.W120A)

a richiesta: VETRO BRONZATO SP.4 MM O SATINATO BIANCO SP.4 MM CON INGLESINA TIPO "A" COLORE GRAFITE

telaio sp.22 mm in massello di rovere nei colori: rovere mielato (opz.W520A), rovere bianco (opz.W525A), rovere grigio terra (opz.W530A)

telaio sp.22 mm in massello noce canaletto nel colore: noce canaletto (opz.W120A)

MANIGLIE

di serie: W50 finitura nichel satinato passo mm 64/160/320 in funzione dell'anta

a richiesta:

W51 finitura verniciato brunito passo mm 64/160/320 in funzione dell'anta

W583 finitura nichel satinato passo mm 16/160 in funzione dell'anta

W30 finitura black satinato passo mm 16/160 in funzione dell'anta

K82 finitura nichel satinato passo mm 128

per anta L 15 pomo passo mm 32 finitura nichel satinato K82P

K82G finitura ghisa passo mm 128

per anta L 15 pomo passo mm 32 finitura ghisa K82GP

W01 finitura nichel satinato passo mm 128

574 finitura acciaio ossidato brown passo mm 16/160/320 in funzione dell'anta

W52 finitura verniciato bronzo passo mm 160/320 in funzione dell'anta

W60 finitura nichel black satinato passo mm 96/160/320 in funzione dell'anta

W10 finitura verniciato brunito passo mm 64/96 in funzione dell'anta

W11 finitura peltro passo mm 64/96 in funzione dell'anta

W 90 ad incasso finitura nichel satinato passo mm 64/128 in funzione dell'anta



CARATTERISTICHE TECNICHE

STRUTTURE

ANTA: rovere mielato

multistrato sp.25 mm bilaminato carbon (opz.W900), bordo carbon (opz.W920)
ripiano multistrato sp.25 mm bilaminato carbon (opz.W900),
schiena in polipropilene lavagna (opz.9620)

ANTA: rovere bianco

multistrato sp.25 mm bilaminato cenere (opz.W750), bordo lino (opz.W770)
ripiano multistrato sp.25 mm bilaminato cenere (opz.W750),
schiena in polipropilene bianco (opz.001)

ANTE: noce canaletto, rovere piombo

multistrato sp.25 mm bilaminato juta (opz.W800), bordo mandorla (opz.W820)
ripiano multistrato sp.25 mm bilaminato juta (opz.W800),
schiena in polipropilene visone (opz.948M)

MENSOLE

di serie: altezza 40 mm listellare laminato nei colori: bianco perla (opz.W700), juta (opz.W800), cenere (opz.W750),
carbon (opz.W900)

a richiesta: altezza 40 mm listellare impiallacciato nei colori:
rovere mielato (opz.W520), rovere bianco (opz.W525) noce canaletto (opz.W120), rovere grigio terra (opz.W530)

ZOCCOLI

di serie: altezza cm 13 in pvc in alluminio satinato (opz.405)

a richiesta: altezza cm 13 in alluminio liscio finitura brill (opz.412) e alluminio titanio (opz.414), vedi maggiorazione pag.35

altezza cm 13 in alluminio laccato nei colori: bianco conchiglia (opz.W720), mandorla (opz.W820), lino (opz.W770),
carbon (opz.W920), vedi maggiorazione pag. 35

I PRODOTTI IN LEGNO SONO CONFORMI AL REGOLAMENTO (US EPA TSCA Title VI) RIGUARDO ALL'EMISSIONE DI FORMALDEIDE



TH. 22 MM

veneered smooth

TECHNICAL FEATURES**DOORS AND DRAWER FRONTS**

smooth door 22 mm th. in oak veneered chipboard with solid wood edges (compliant with [US EPA TSCA Title VI](#)) in the following colours: honey oak (opt.W520), white oak (opt.W525), earth grey oak (opt.W530)

smooth door 22 mm th. in canaletto walnut veneered chipboard with solid wood edges in the following colour: canaletto walnut (opt.W120)

GLASS DOORS**standard: 4 MM TH. EXTRA LIGHT CLEAR GLASS**

frame 22 mm th. in solid oak in the following colours: honey oak (opt.W520), white oak (opt.W525), earth grey oak (opt.W530)

frame 22 mm th. in solid canaletto walnut in the following colour: canaletto walnut (opt.W120)

on request: 4 MM TH. BRONZED GLASS OR 4 MM TH. WHITE FROSTED GLASS

frame 22 mm th. in solid oak in the following colours: honey oak (opt.W520), white oak (opt.W525), earth grey oak (opt.W530)

frame 22 mm th. in solid canaletto walnut in the following colour: canaletto walnut (opt.W120)

GLASS DOORS WITH MULLION ACCENTS**standard: 4 MM TH. EXTRA LIGHT CLEAR GLASS WITH TYPE "A" MULLION ACCENTS GRAPHITE COLOUR**

frame 22 mm th. in solid oak in the following colours: honey oak (opt.W520A), white oak (opt.W525A), earth grey oak (opt.W530A)

frame 22 mm th. in solid canaletto walnut in the following colour: canaletto walnut (opt.W120A)

on request: 4 MM TH. BRONZED GLASS OR 4 MM TH. WHITE FROSTED GLASS WITH TYPE "A" MULLION ACCENTS GRAPHITE COLOUR

frame 22 mm th. in solid oak in the following colours: honey oak (opt.W520A), white oak (opt.W525A), earth grey oak (opt.W530A)

frame 22 mm th. in solid canaletto walnut in the following colour: canaletto walnut (opt.W120A)

HANDLES

standard: W50 satin nickel finish, 64/160/320 centre-to-centre distance depending on the door

on request:

W51 burnished painted finish, 64/160/320 mm centre-to-centre distance depending on the door

W583 satin nickel finish, 16/160 centre-to-centre distance according to door size

W30 satin black finish, 16/160 centre-to-centre distance according to door size

K82 satin nickel finish, 128 mm centre-to-centre distance

for door W 15 satin-finish nickel knob hole K82P 32 mm centre-to-centre distance

K82G cast iron finish, 128 mm centre-to-centre distance

for door W 15 cast iron finish knob hole K82GP 32 mm centre-to-centre distance

W01 satin nickel finish, 128 mm centre-to-centre distance

574 brown rusted steel finish, 16/160/320 centre-to-centre distance depending on the door

W52 painted bronze finish, 160/320 mm centre-to-centre distance

W60 black satin nickel finish, 96/160/320 centre-to-centre distance depending on the door

W10 painted burnished finish, 64/96 mm centre-to-centre distance

W11 pewter finish, 64/96 mm centre-to-centre distance

W 90 recessed satin nickel finish, 64/128 centre-to-centre distance according to door size



TECHNICAL FEATURES

CARCASSES

DOOR: honey oak

25 mm th. two-sided laminated plywood in carbon (opt.W900), carbon edge (opt.W920)
25 mm th. two-sided laminated plywood shelf in carbon (opt.W900),
slate grey polypropylene back panel (opt.9620)

DOOR: white oak

25 mm th. two-sided laminated plywood in ash (opt.W750), linen edge (opt.W770)
25 mm th. two-sided laminated plywood shelf in ash (opt.W750),
white polypropylene back panel (opt.001)

DOORS: canaletto walnut, lead grey oak

25 mm th. two-sided laminated plywood in jute (opt.W800), almond edge (opt.W820)
25 mm th. two-sided laminated plywood shelf in jute (opt.W800),
mink polypropylene back panel (opt.948M)

SHELVES

standard: height 40 mm laminated blockboard in the following colours: pearl white (opt.W700), jute (opt.W800), ash (opt.W750),
carbon (opt.W900)

on request: height 40 mm veneered blockboard in the following colours: honey oak (opt.W520), white oak (opt.W525),
canaletto walnut (opt.W120), earth grey oak (opt.W530)

PLINTHS

standard: height 13 cm, in PVC with satin-finish aluminium finish (opt.405)

on request: height 13 cm, in smooth aluminium with brill finish (opt.412), and titanium aluminium (opt.414), see surcharges on page 35

height 13 cm, in lacquered aluminium in the following colours: shell white (opt.W720), almond (opt.W820), linen (opt.W770),
carbon (opt.W920), see surcharges on page 35

WOODEN PRODUCTS ARE COMPLIANT WITH REGULATIONS (US EPA TSCA Title VI) GOVERNING FORMALDEHYDE EMISSIONS



SP. 22 MM / TH. 22 MM

ante
doors



anta rovere mielato
(opz. W520)
honey oak door
(opt. W520)



frontale cassetto
drawer front panel



frontale cestone
deep drawer front panel



anta rovere grigio terra
(opz. W530)
earth grey oak door
(opt. W530)



frontale cassetto
drawer front panel



frontale cestone
deep drawer front panel



anta rovere bianco
(opz. W525)
white oak door
(opt. W525)



frontale cassetto
drawer front panel



frontale cestone
deep drawer front panel



anta noce canaletto
(opz. W120)
canaletto walnut door
(opt. W120)



frontale cassetto
drawer front panel



frontale cestone
deep drawer front panel



SP. 22 MM / TH. 22 MM

ante vetro laccate
lacquered glass doors

tipologia ante vetro
glass doors type



anta mandorla con
vetro extra chiaro (opz. TRA)
almond door
with extra light glass (opt. TRA)



anta mandorla con
vetro bianco satinato
(opz. SAT)
almond door with
frosted white glass
(opt. SAT)



anta mandorla con
vetro bronzo (opz. BRO)
almond door with
bronze glass (opt. BRO)

N.B.: disponibili in tutti i colori
come ante laccate, vedi pag.10

Note: available in all lacquered
door colours, see page 10

tipologia ante vetro con inglesina
panelled glass doors type with mullion accents



anta mandorla con
vetro extra chiaro
inglesina tipo "A" grafite
almond door with
extra light glass
with type "A" mullion accents
graphite



anta mandorla con
vetro extra chiaro
inglesina tipo "A" laccata opaco
almond door with
extra light glass
with type "A" mullion accents
matt lacquered

N.B.: di serie: inglesina color grafite

Note: standard: graphite coloured mullion accents

N.B.: a richiesta: inglesina color mandorla (opz. W820C),
bianco conchiglia (opz. W720C), lino (opz. W770C)

Note: on request: colour mullion accents almond (opt. W820C),
shell white (opt. W720C), linen (opt. W770C)



anta mandorla con
vetro extra chiaro
inglesina tipo "B"
almond door with
extra light glass
with type "B" mullion accents

N.B.: apertura con presa sul fondo dell'anta
Note: grip on bottom opening of the door

SP. 22 MM / TH. 22 MM

tipologia ante vetro
glass doors type



anta noce canaletto con
vetro extra chiaro (opz.TRA)
canaletto walnut door
with extra light glass (opt.TRA)



anta noce canaletto con
vetro bianco satinato
(opz.SAT)
canaletto walnut door with
frosted white glass
(opt.SAT)



anta noce canaletto con
vetro bronzo (opz.BRO)
canaletto walnut door
with bronze glass (opt.BRO)

N.B.: disponibili in tutti i colori
come ante impiallacciate, vedi pag.22

Note: available in all veneered
door colours, see page 22

VETRO
GLASS

tipologia anta vetro con inglesina
panelled glass doors type with mullion accents



anta noce canaletto con
vetro extra chiaro
inglesina tipo "A"
canaletto walnut door with
extra light glass
with type "A" mullion accents

N.B.: inglesina color grafite
Note: graphite coloured mullion accents

MANIGLIE HANDLES

DI SERIE STANDARD



Maniglia W50 finitura nichel satinato
anta L 15 → passo 64 mm
anta da L 30 a L 60 → passo 160 mm
anta L 90 → passo 320 mm

Handle W50 satin nickel finish
door W 15 → centre-to-centre distance 64 mm
door from W 30 to W 60 → centre-to-centre distance 160 mm
door W 90 → centre-to-centre distance 320 mm

A RICHIESTA ON REQUEST



Maniglia W51 finitura verniciato brunito
anta L 15 → passo 64 mm
anta da L 30 a L 60 → passo 160 mm
anta L 90 → passo 320 mm

Handle W51 burnished painted finish
door W 15 → centre-to-centre distance 64 mm
door from W 30 to W 60 → centre-to-centre distance 160 mm
door W 90 → centre-to-centre distance 320 mm

A RICHIESTA ON REQUEST



Maniglia W60 finitura nichel black satinato
anta L 15 → passo 96 mm in verticale
anta da L 30 a L 45 → passo 160 mm
anta da L 60 a L 90 → passo 320 mm

Handle W60 satin nickel black finish
door W 15 → centre-to-centre distance 96 mm vertical
door from W 30 to W 45 → centre-to-centre distance 160 mm
door from W 60 to W 90 → centre-to-centre distance 320 mm

A RICHIESTA ON REQUEST



Maniglia W583 finitura nichel satinato
anta L 15 → passo 16 mm
anta da L 30 a L 90 → passo 160 mm

Handle W583 satin nickel finish
door W 15 → centre-to-centre distance 16 mm
door from W 30 to W 90 → centre-to-centre distance 160 mm

A RICHIESTA ON REQUEST



Maniglia W30 finitura black satinato
anta L 15 → passo 16 mm
anta da L 30 a L 90 → passo 160 mm

Handle W30 satin black finish
door W 15 → centre-to-centre distance 16 mm
door from W 30 to W 90 → centre-to-centre distance 160 mm

A RICHIESTA ON REQUEST



Maniglia 574 finitura acciaio ossidato brown
anta L 15 → passo 16 mm
anta da L 30 a L 45 → passo 160 mm
anta da L 60 a L 90 → passo 320 mm

Handle 574 brown oxidized steel finish
door W 15 → centre-to-centre distance 16 mm
door from W 30 to W 45 → centre-to-centre distance 160 mm
door from W 60 to W 90 → centre-to-centre distance 320 mm

A RICHIESTA ON REQUEST



Maniglia K82 finitura nichel satinato
anta L 30 a L 90 → passo 128 mm

Handle K82 satin nickel finish
door W 30 to W 90 → centre-to-centre distance 128 mm



Pomo K82P finitura nichel satinato
passo 32 mm
utilizzata per elementi da 15 con maniglia K82

Knob K82P satin nickel finish
centre-to-centre distance 32 mm
used for W 15 elements with handle K82

A RICHIESTA ON REQUEST



Maniglia W01 finitura nichel satinato
anta L 15 → passo 128 mm in verticale
anta da L 30 a L 90 → passo 128 mm

Handle W01 satin nickel finish
door W 15 → centre-to-centre distance 128 mm vertical
door from W 30 to W 90 → centre-to-centre distance 128 mm

A RICHIESTA ON REQUEST



Maniglia K82G finitura ghisa
anta L 30 a L 90 → passo 128 mm

Handle K82G cast iron finish
door W 30 to W 90 → centre-to-centre distance 128 mm



Pomo K82GP finitura ghisa
passo 32 mm
utilizzata per elementi da 15 con maniglia K82G

Knob K82GP cast iron finish
centre-to-centre distance 32 mm
used for W 15 elements with handle K82G

A RICHIESTA ON REQUEST



Maniglia W52 finitura verniciato bronzo
anta L 15 → passo 160 mm in verticale
anta da L 30 a L 60 → passo 160 mm
anta L 90 → passo 320 mm

Handle W52 bronze painted finish
door W 15 → centre-to-centre distance 160 mm vertical
door from W 30 to W 60 → centre-to-centre distance 160 mm
door W 90 → centre-to-centre distance 320 mm

PROVENZA

MANIGLIE HANDLES

A RICHIESTA ON REQUEST



Maniglia W10 finitura verniciato brunito
anta L 15 → passo 64 mm
anta da L 30 a L 90 → passo 96 mm

Handle W10 burnished painted finish
door W 15 → centre-to-centre distance 64 mm
door from W 30 to W 90 → centre-to-centre distance 96 mm



Maniglia W11 finitura peltro
anta L 15 → passo 64 mm
anta da L 30 a L 90 → passo 96 mm

Handle W11 pewter finish
door W 15 → centre-to-centre distance 64 mm
door from W 30 to W 90 → centre-to-centre distance 96 mm



MANIGLIE
HANDLES

MANIGLIA AD INCASSO RECESSED HANDLE



Maniglia W90 finitura nichel satinato
anta L 15 → passo 64 mm
anta da L 30 a L 90 → passo 128 mm

Handle W90 satin nickel finish
door W 15 → centre-to-centre distance 64 mm
door from W 30 to W 90 → centre-to-centre distance 128 mm



PROVENZA

strutture SP.2,5 carcasses Th.2,5



bianco perla (opz.W700)
bordo bianco conchiglia (opz.W720)
ripiano bianco perla (opz.W700)
schiena bianco (opz.001)
pearl white (opt.W700)
shell white edge (opt.W720)
pearl white shelf (opt.W700)
white back panel (opt.001)



juta (opz.W800)
bordo mandorla (opz.W820)
ripiano juta (opz.W800)
schiena visone (opz.948M)
jute (opt.W800)
almond edge (opt.W820)
jute shelf (opt.W800)
mink back panel (opt.948M)



cenere (opz.W750)
bordo lino (opz.W770)
ripiano cenere (opz.W750)
schiena bianco (opz.001)
ash (opt.W750)
linen edge (opt.W770)
ash shelf (opt.W750)
white back panel (opt.001)



carbon (opz.W900)
bordo carbon (opz.W920)
ripiano carbon (opz.W900)
schiena lavagna (opz.9620)
carbon (opt.W900)
carbon edge (opt.W920)
carbon shelf (opt.W900)
slate grey back panel (opt.9620)



particolare strutture in multistrato
ply carcasses particular

N.B.: prodotti conformi al regolamento US EPA TSCA Title VI riguardo emissione formaldeide
Note: products are compliant with US EPA TSCA TITLE VI regulations governing formaldehyde emissions

mensole in listellare laminato P 32/61 SP.4 laminate blockboard shelves D 32/61 Th.4



bianco perla (opz.W700)
bordo bianco conchiglia (opz.W720)
pearl white (opt.W700)
shell white edge (opt.W720)



juta (opz.W800)
bordo mandorla (opz.W820)
jute (opt.W800)
almond edge (opt.W820)



cenere (opz.W750)
bordo lino (opz.W770)
ash (opt.W750)
linen edge (opt.W770)



carbon (opz.W900)
bordo carbon (opz.W920)
carbon (opt.W900)
carbon edge (opt.W920)

mensole in listellare laccate P 32/61 SP.4 lacquered blockboard shelves D 32/61 Th.4



bianco conchiglia (opz.W720)
shell white (opt.W720)



mandorla (opz.W820)
almond (opt.W820)



lino (opz.W770)
linen (opt.W770)



coloniale (opz.W870)
colonial (opt.W870)



carbon (opz.W920)
carbon (opt.W920)

mensole in listellare impiallacciate P 32/61 SP.4 veneered blockboard shelves D 32/61 Th.4



rovere mielato (opz.W520)
honey oak (opt.W520)



rovere bianco (opz.W525)
white oak (opt.W525)



noce canaletto (opz.W120)
canaletto walnut (opt.W120)



rovere grigio terra (opz.W530)
earth grey oak (opt.W530)

zoccolo in pvc H 13 pvc plinth H 13

di serie
standard



alluminio satinato (opz.405)
satin aluminium (opt.405)

zoccolo in alluminio H 13 aluminium plinth H 13



alluminio finitura brill (opz.412)
aluminium brill finish (opt.412)



alluminio finitura titanio ossidato (opz.414)
aluminium titanium oxidized finish (opt.414)

zoccoli in alluminio H 13 verniciati a polvere finitura opaca aluminium plinths H 13 powder coated matt finish



bianco conchiglia (opz.W720)
shell white (opt.W720)



mandorla (opz.W820)
almond (opt.W820)



lino (opz.W770)
linen (opt.W770)



carbon (opz.W920)
carbon (opt.W920)

top H 4 consigliati in laminato bordo ABS 1 recommended laminate worktops H 4 with ABS 1 edge

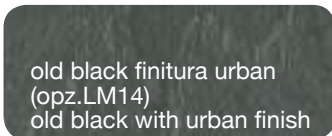

old black finitura urban
(opz.LM14)
old black with urban finish

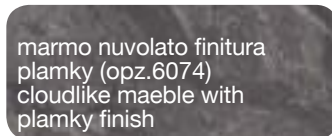

marmo nuvolato finitura
plamky (opz.6074)
cloudlike maeble with
plamky finish

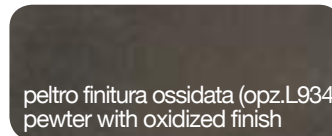

peltro finitura ossidata (opz.L934)
pewter with oxidized finish

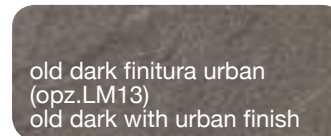

old dark finitura urban
(opz.LM13)
old dark with urban finish



jaipur finitura plamky (opz.5564)
jaipur with plamky finish

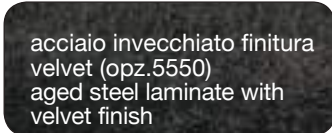

acciaio invecchiato finitura
velvet (opz.5550)
aged steel laminate with
velvet finish

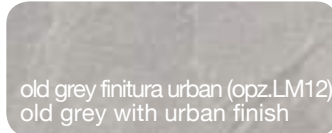

old grey finitura urban (opz.LM12)
old grey with urban finish

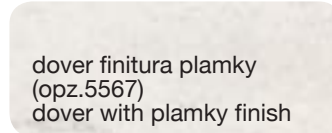

dover finitura plamky
(opz.5567)
dover with plamky finish

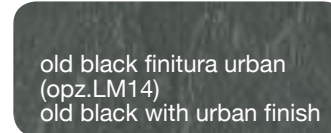

old black finitura urban
(opz.LM14)
old black with urban finish

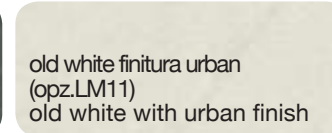

old white finitura urban
(opz.LM11)
old white with urban finish

top H 4 consigliati in laminato Fenix recommended laminate worktops H 4 with Fenix

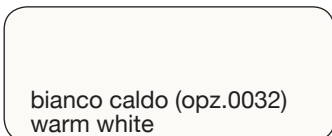

bianco caldo (opz.0032)
warm white

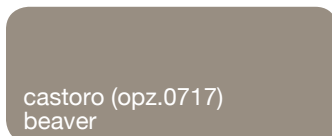

castoro (opz.0717)
beaver

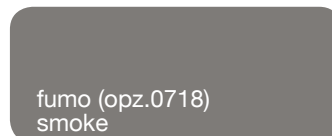

fumo (opz.0718)
smoke

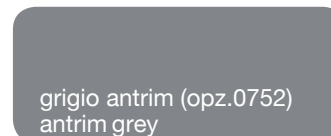

grigio antrim (opz.0752)
antrim grey

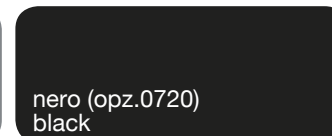

nero (opz.0720)
black



beige arizona (opz.0748)
arizona beige

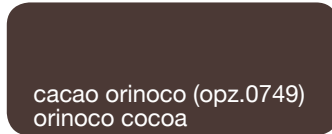

cacao orinoco (opz.0749)
orinoco cocoa

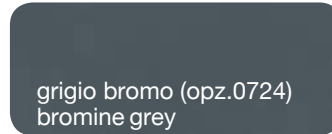

grigio bromo (opz.0724)
bromine grey

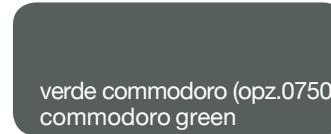

verde commodoro (opz.0750)
commodoro green

top H 4 consigliati in laminato Unicolor recommended laminate worktops H 4 with Unicolor



carnico opaco finitura plamky
(opz.5558)
carnico with plamky finish

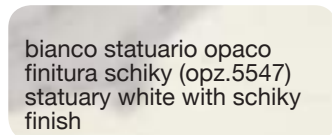

bianco statuario opaco
finitura schiky (opz.5547)
statuary white with schiky
finish

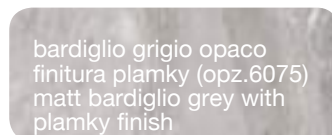

bardiglio grigio opaco
finitura plamky (opz.6075)
matt bardiglio grey with
plamky finish

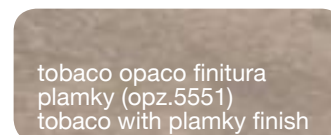

tabacco opaco finitura
plamky (opz.5551)
tobacco with plamky finish

MODULARITÀ E COMPONIBILITÀ MODULARITY AND FITTING SOLUTIONS

pensili - scolapiatti
2 ante a ribalta
wall units - plate rack units
with 2 flap doors

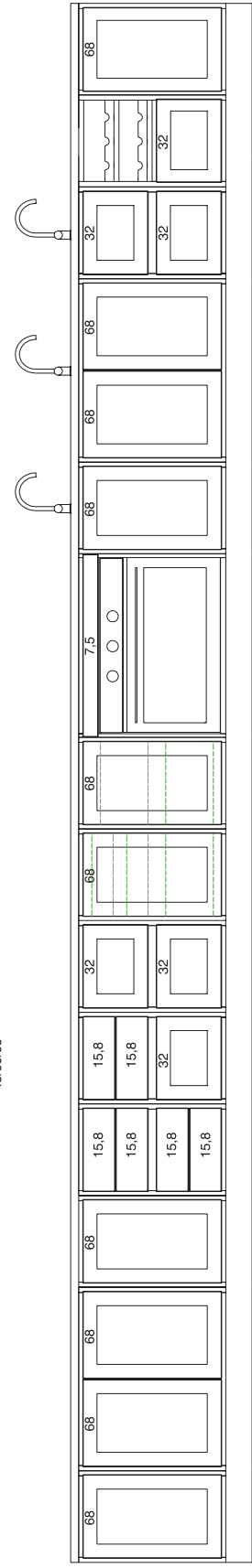
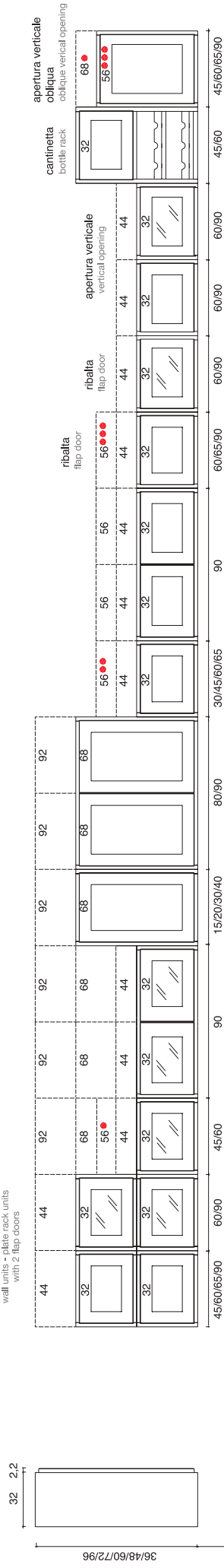

15/20/30/40
45/60/65 80/90 45/60 30/40/45/60 45/60/90 45/60 45/60
20/30/45 cest.estr. pull-out basket
45/60 2 cassetti 2 cestoni interni
45/60 2 cassetti 1 cestone interni
60/90 1 cassetto interno 2 internal deep drawers
60/90 1 cassetto interno 1 internal deep drawer

• escluso 45 excluding
• escluso 30/65 excluding 30/65
• escluso 65 excluding 65

BASI H 73 BASE UNITS H 73

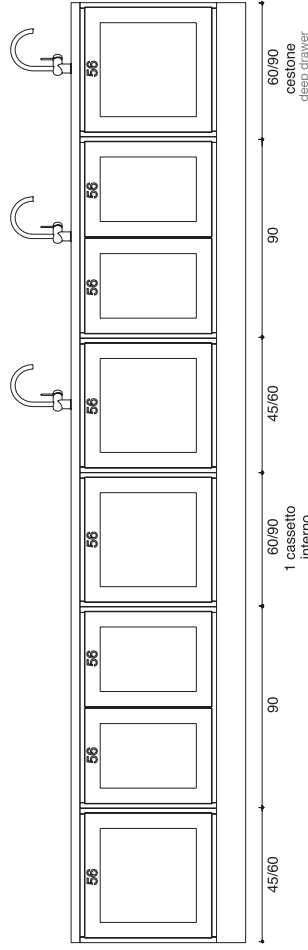
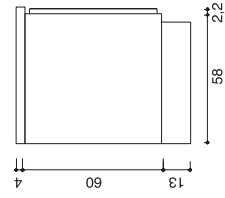

BASI SOSPESE HANGING BASE UNITS

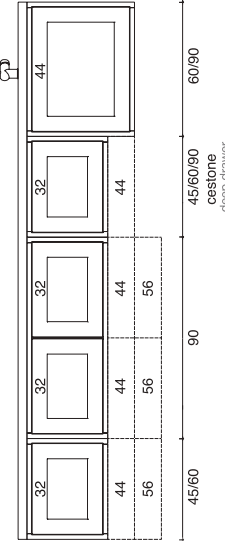
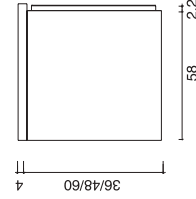

BASI LIVING CON PIEDINI NERI H 2,5 ROOM UNITS WITH FEET BLACK H 2,5

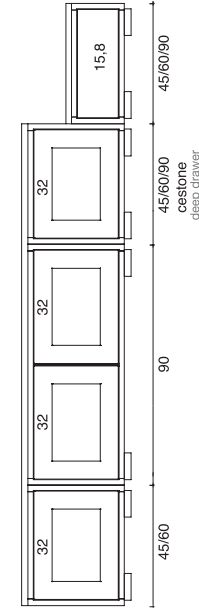
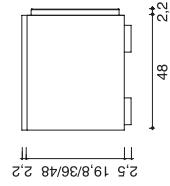

BASI LIVING ROOM UNITS

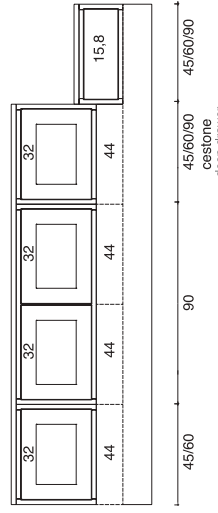
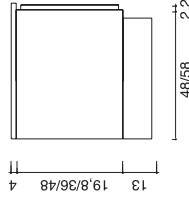

MODULARITÀ E COMPONENTIBILITÀ MODULARITY AND FITTING SOLUTIONS

COLONNE COLUMNS

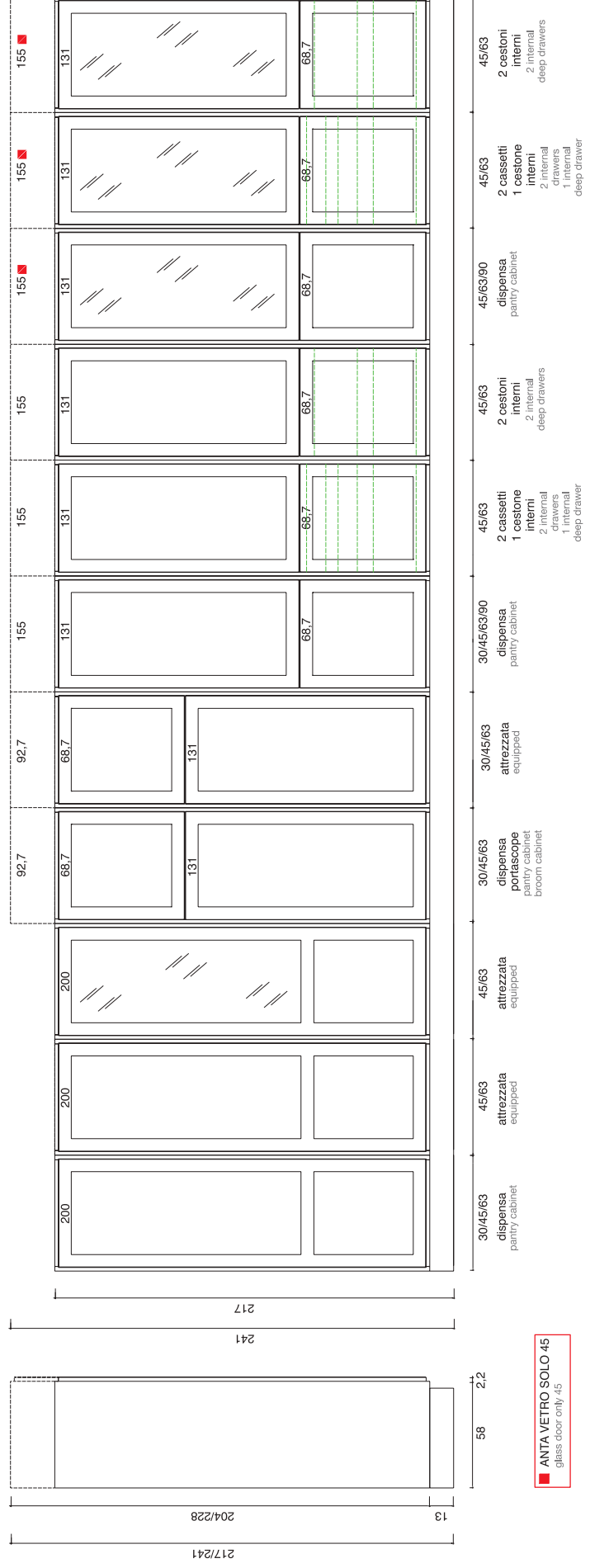
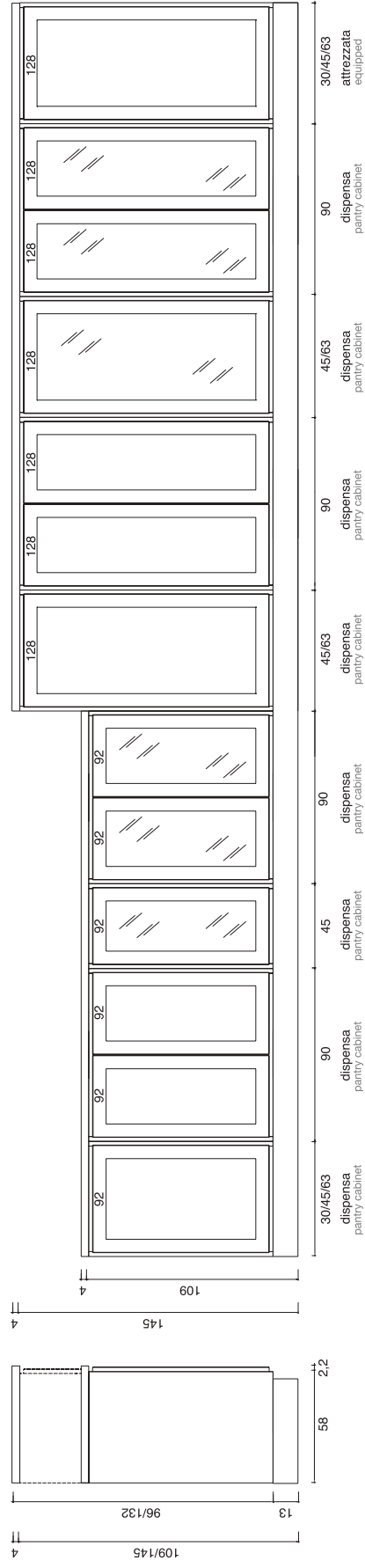

■ ANTA VETRO SOLO 45
glass door only 45

MODULARITÀ E COMPONENTI MODULARITÀ AND FITTING SOLUTIONS

COLONNE FRIGO FRIDGE COLUMNS

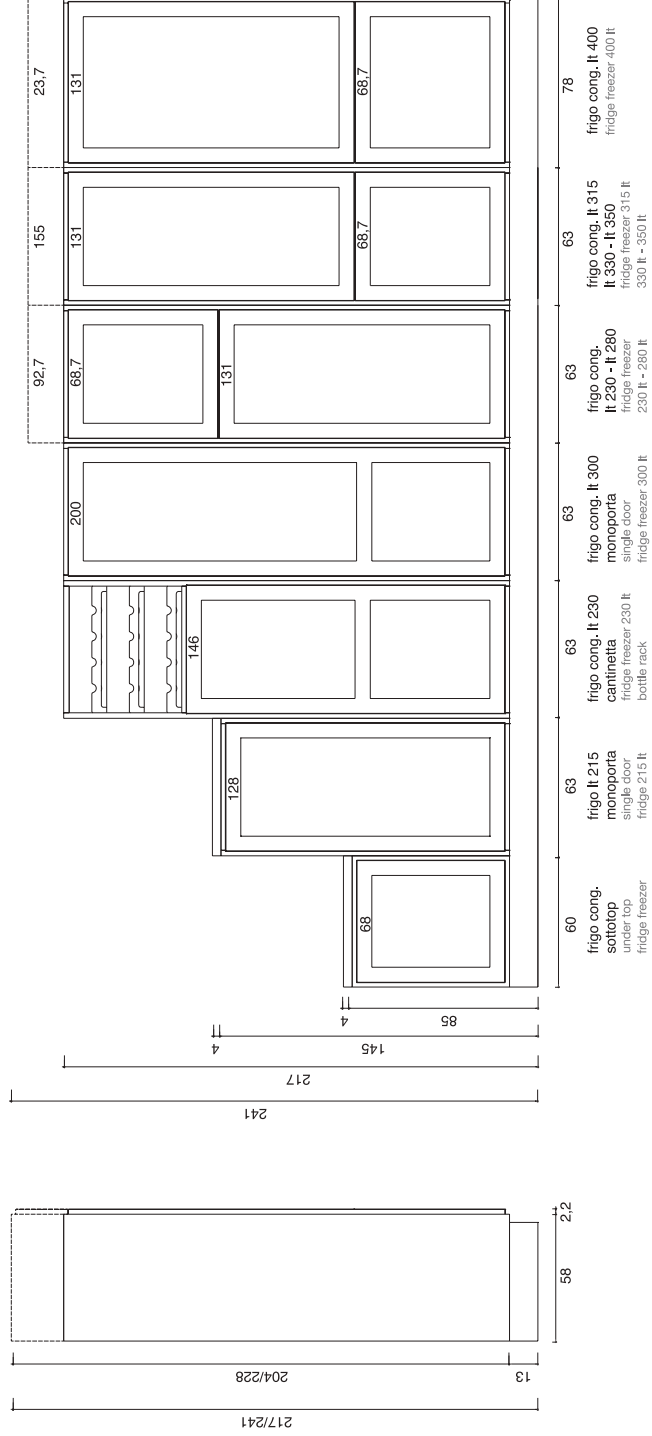

COLONNE FORNO OVEN COLUMNS

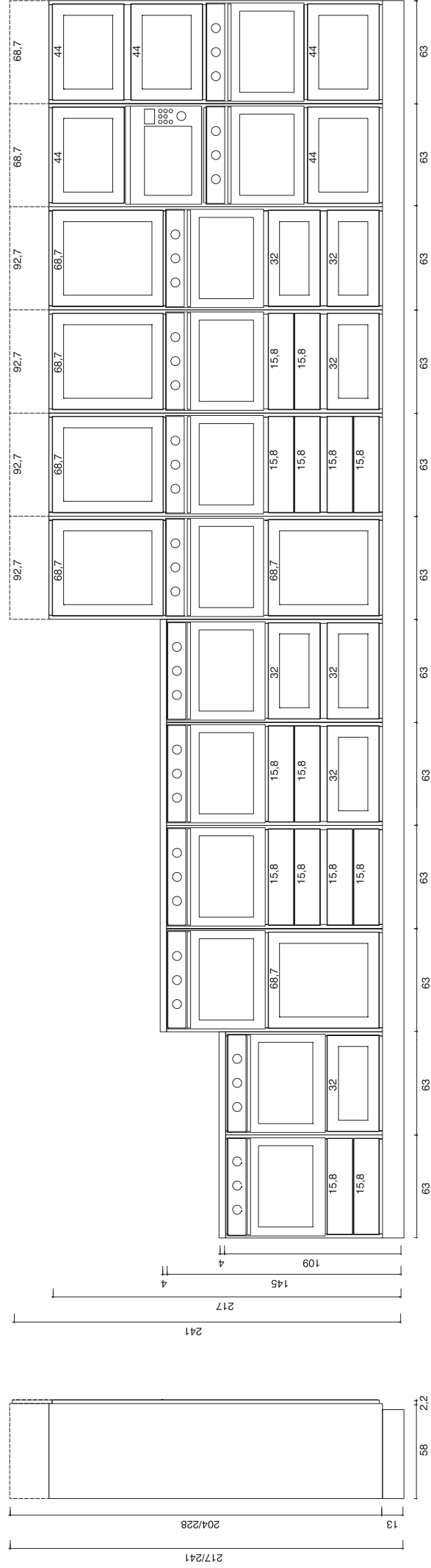



APERTURA A RIBALTA

Le ante aprendosi verso l'alto consentono di avere un' ampia visione d'insieme all'interno del mobile.

La regolazione della forza di apertura può essere impostata in modo esatto in base al peso del frontale. Grazie all'arresto progressivo le ante si fermano in qualsiasi posizione; in questo modo la maniglia è sempre facilmente raggiungibile. La chiusura è ammortizzata e un'unica manovra è sufficiente per regolare il frontale tridimensionalmente grazie all'assenza di cerniere e al sistema di aggancio clip.

WALL UNIT WITH FLAP DOOR

The doors that open upwards guarantee ample overall visibility inside the cabinet.

The opening force can be adjusted precisely according to the weight of the front. The doors stop in any position thanks to the gradual stopping movement; in this way, the handle is always easily accessible. The closing movement is cushioned and a single manoeuvre is required to three-dimensionally adjust the front, thanks to the clip-on system and the absence of hinges.



DI SERIE
STANDARD

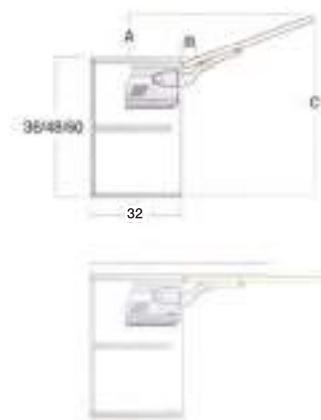

	A	B	C
H 36	11,5	3,5	37
H 48	15	3,5	49
H 60	18,5	3,5	61

Per evitare l'interferenza dell'anta in fase di apertura con cornici o mensole, si può richiedere il limitatore dell'angolo di apertura cod. 5620010 € 10

In order to avoid that the door interferes with cornices or shelves during the opening movement, it is possible to request an opening angle limiter: code 5620010 € 10

SCHEMA MONTAGGIO LIMITATORE
PER RIBALTA H 36
FLAP DOOR LIMITER INSTALLATION
DIAGRAM H 36

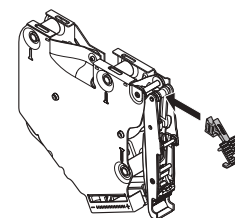

SCHEMA MONTAGGIO LIMITATORE
PER RIBALTA H 48
FLAP DOOR LIMITER INSTALLATION
DIAGRAM H 48

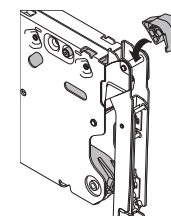

APERTURA VERTICALE OBLIQUA

I pensili con questo tipo di meccanismo necessitano per l'apertura di poco spazio libero sopra il mobile grazie al movimento basculante dell'anta che si apre senza difficoltà applicando poca forza anche in presenza di frontali pesanti. Con l'arresto progressivo le ante si fermano in qualsiasi posizione; in questo modo la maniglia è sempre facilmente raggiungibile. La chiusura è ammortizzata ed è possibile regolare la forza di tenuta in base al peso del frontale.

VERTICAL OPENING OBLIQUE

Wall units that mount this type of mechanism require little clearance above the cabinet thanks to the swivelling movement of the door that can be easily opened by applying slight pressure, even with heavy fronts. The doors stop in any position thanks to the gradual stopping movement; in this way, the handle is always easily accessible. The closing movement is cushioned and the closing force can be adjusted according to the weight of the front door.



DI SERIE
STANDARD

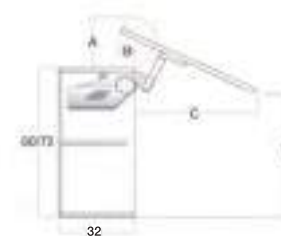

	A	B	C	D
H 60	18	9,6	46,5	53,5
H 72	18	9,6	57	61

APERTURA VERTICALE

L'anta ad apertura verticale, potendo essere sollevata completamente verso l'alto, consente un accesso totale all'interno del pensile. Ideale per l'impiego in mobili a colonna per nascondere ad esempio apparecchi elettrici, o pensili con corpi mobili sovrastanti, ha la chiusura ammortizzata e la possibilità di regolare la forza di tenuta in base al peso del frontale.

VERTICAL OPENING

Doors with vertical opening movement can be fully raised to fully access the inside of the wall unit.

Ideal for use on column units to conceal electrical appliances for examples, or on wall units surmounted by mobile units.

The closing movement is cushioned and the closing force can be adjusted according to the weight of the front door.





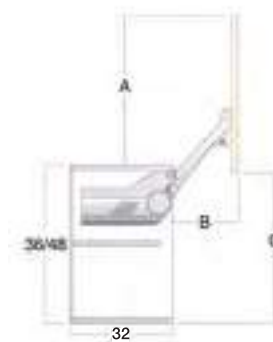







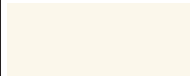





**DI SERIE
STANDARD**



	A	B	C	
H 36	34	23,5	34,5	
H 48	43	28,5	43,5	

MENSOLE

SHELVES

	CODICE			CODICE			
<p>mensola listellare sp. 4 in laminato L. max cm 300 laminate listel shelf th.4 max lenght 300 cm</p>  <p>finiture: finishes</p> <div style="display: flex; justify-content: space-around;"> <div style="text-align: center;">  bianco perla (opz.W700) pearl white </div> <div style="text-align: center;">  juta (opz.W800) jute </div> </div> <div style="display: flex; justify-content: space-around; margin-top: 10px;"> <div style="text-align: center;">  cenere (opz.W750) ash </div> <div style="text-align: center;">  carbon (opz.W900) carbon </div> </div> <p style="text-align: right;">al ml per lm P 32 P 61</p>	W9S603 W9S606			<p>mensola listellare sp. 4 laccata come anta L max cm 300 N.B.: quantità minima 0,5 ml lacquered listel shelf Th. 4 same as door, max Length 300 cm NOTE: minimum quantity 0,5 lm</p>  <p>finiture: finishes</p> <div style="display: flex; justify-content: space-around;"> <div style="text-align: center;">  bianco conchiglia (opz.W720) shell white </div> <div style="text-align: center;">  mandorla (opz.W820) almond </div> <div style="text-align: center;">  coloniale (opz.W870) colonial </div> </div> <div style="display: flex; justify-content: space-around; margin-top: 10px;"> <div style="text-align: center;">  lino (opz.W770) linen </div> <div style="text-align: center;">  carbon (opz.W920) carbon </div> </div> <p style="text-align: right;">LACCATA OPACA al ml Matt Lacquered prices per lm P 32 P 61</p>	W9L603 W9L606		
<p>mensola listellare sp. 4 impiallacciata colore come anta L. max cm 300</p>  <p>N.B.: quantità minima 0,5 ml</p> <p>veneered listel shelf th.4 colour matching with door max: lenght 300 cm</p> <p>NOTE: minimum quantity 0,5 lm</p> <div style="display: flex; justify-content: space-around; margin-top: 10px;"> <div style="text-align: center;">  rovere mielato (opz.W520) honey oak </div> <div style="text-align: center;">  rovere grigio terra (opz.W530) earth grey oak </div> </div> <div style="display: flex; justify-content: space-around; margin-top: 10px;"> <div style="text-align: center;">  rovere bianco (opz.W525) white oak </div> <div style="text-align: center;">  noce canaletto (opz.W120) canaletto walnut </div> </div> <p style="text-align: right;">al ml per lm P 32 P 61</p>	W9I603 W9I606			<p>reggimensola a scomparsa fully integrated shelf bracket</p>  <p style="text-align: right;">cadauno each</p>	08610400		

VIVI IL LIVING

LIVE THE LIVING

La grande componibilità degli elementi pensili e delle basi sospese consente di creare composizioni living perfettamente coordinate con la cucina.

Versatile fitting solutions for living room wall units and suspended base units coordinated with kitchen spaces.



LIVING 01



ANTA
door

MANDORLA
almond

ELEMENTI A GIORNO
open units

MANDORLA
almond

STRUTTURA
carcass

JUTA
jute

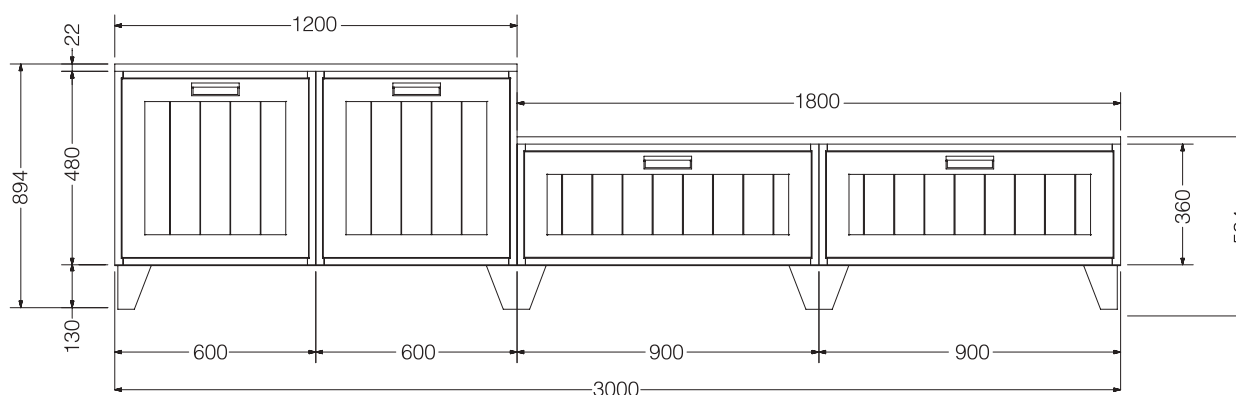
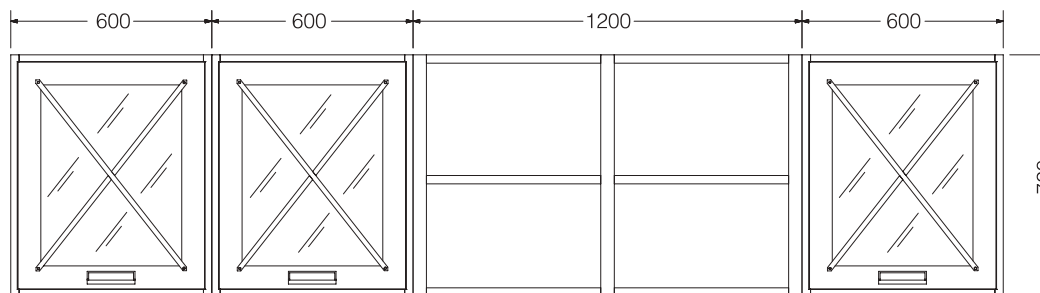

NR. ELEMENTI	DESCRIZIONE	CODICE
2	Pensile L 60 H 72 P 34,4 anta vetro con inglesina tipo "A", 1 ianco come anta	WPVA40601/2
1	Pensile L 60 H 72 P 34,4 anta vetro con inglesina tipo "A", ianchi come anta	WPVA40601/2
1	Elemento a giorno "tipo 3" L 120 H 72 P 32 laccato come anta	WMBB41200
2	Base living L 60 H 48 P 50,4, 1 anta a doghe, 1 fianco come anta	WLA20601/2
1	Base living L 90 H 36 P 50,4, 1 cestone a doghe	WLB10900
1	Base living L 90 H 36 P 50,4, 1 cestone a doghe, 1 fianco come anta	WLB10900
1	Top laccato L 120 P 51 spessore 2,2	al ml W9TL205
1	Top laccato L 180 P 51 spessore 2,2	al ml W9TL205
4	Piede living legno H 13 laccato, laterale	5BPLL01
4	Piede living legno H 13 laccato, centrale	5BPLL05

No. of ELEMENTS	DESCRIPTION	CODE
2	Wall unit W 60 H 72 D 34,4 glass door with "type A" mullion accents, 1 side same as door	WPVA40601/2
1	Wall unit W 60 H 72 D 34,4 glass door with "type A" mullion accents, sides same as door	WPVA40601/2
1	"Type 3" open unit W 120 H 72 D 32, lacquered same as door	WMBB41200
2	Living base unit W 60 H 48 D 50,4, 1 door with slats side as door	WLA20601/2
1	Living base unit W 90 H 36 D 50,4, 1 deep drawer with slats	WLB10900
1	Living base unit W 90 H 36 D 50,4, 1 deep drawer with slats, side same as door	WLB10900
1	Lacquered worktop W 120 D 51 TH.2,2	per lm W9TL205
1	Lacquered worktop W 180 D 51 TH.2,2	per lm W9TL205
4	Wooden lacquered foot H 13, lateral	5BPLL01
4	Wooden lacquered foot H 13, central	5BPLL05

LIVING 02



ANTE
doors

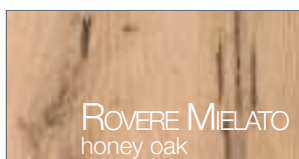

STRUTTURA
carcass

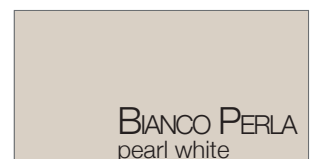

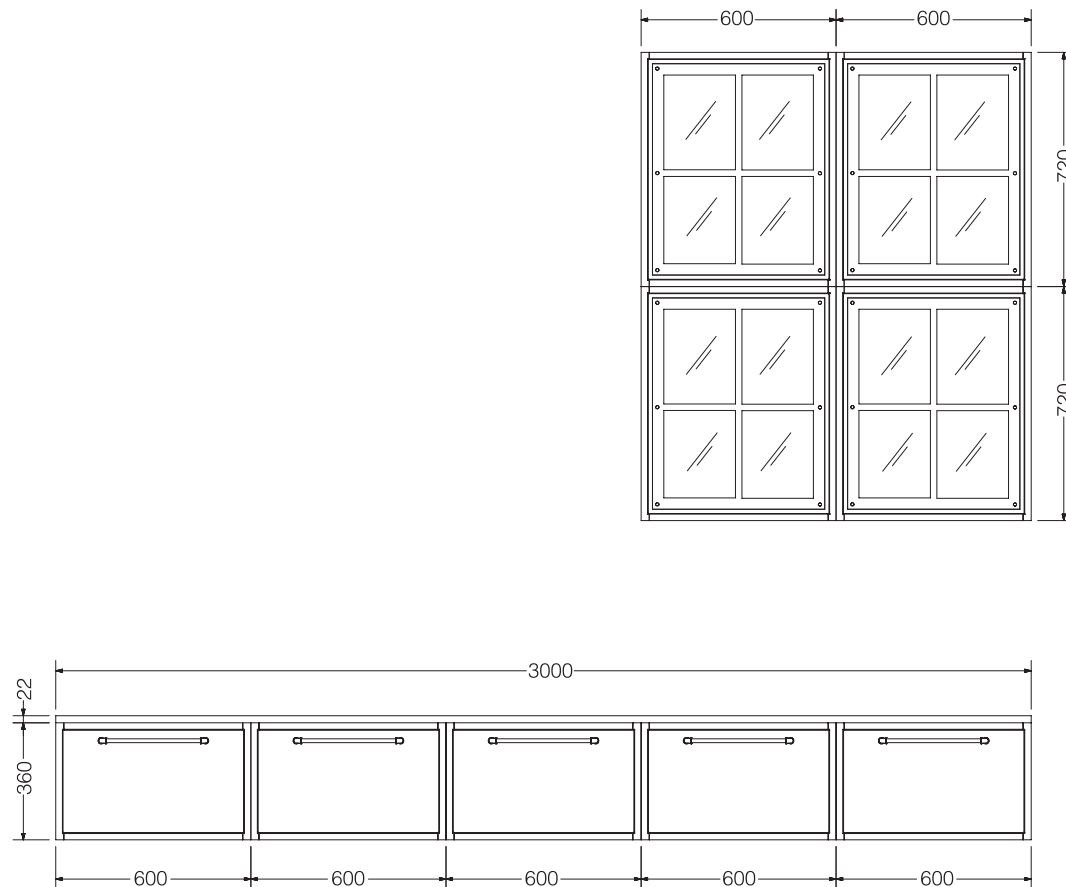

NR. ELEMENTI	DESCRIZIONE	CODICE
4	Pensile L 60 H 72 P 34,4 anta vetro con inglesina tipo "B", apertura push pull	WPVA40601/2
5	Base living sospesa L 60 H 36 P 50,4, 1 cestone	WLSB10600
1	Top laccato L 300 P 51 spessore 2,2	al ml W9TL205
No. of ELEMENTS	DESCRIPTION	CODE
4	Wall unit W 60 H 72 D 34,4 glass door with "type B" mullion accents, push-pull opening	WPVA40601/2
5	Hanging living base unit W 60 H 36 D 50,4, 1 deep drawer	WLSB10600
1	Lacquered worktop W 300 D 51 TH.2,2	per lm W9TL205

LIVING 03



ANTE
doors

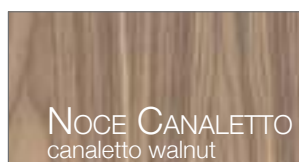

STRUTTURE
carcasses



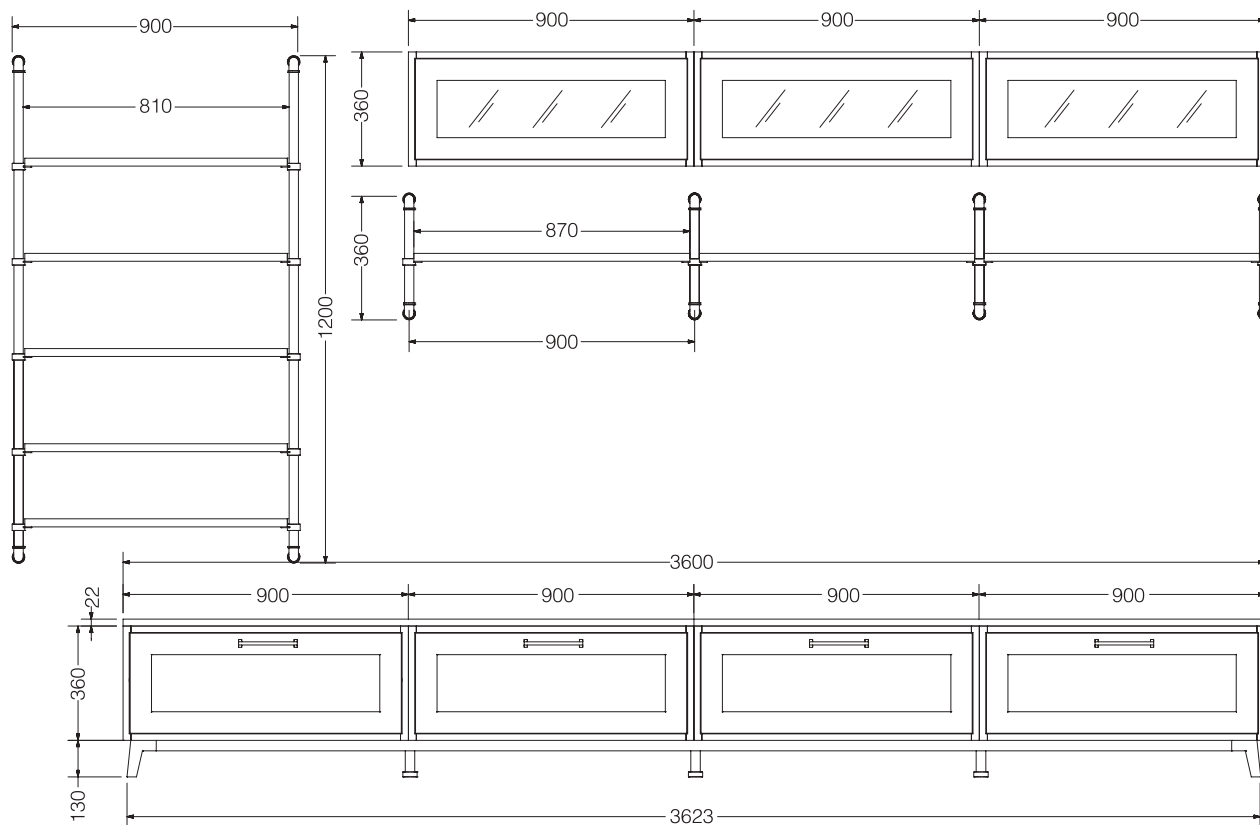

NR. ELEMENTI	DESCRIZIONE	CODICE
3	Pensile L 90 H 36 P 34,4 1 anta vetro ribalta, apertura push pull	WPVF10900
4	Base living L 90 H 36 P 50,4, 1 cestone	WLB10900
2	Top laccato L 180 P 51 spessore 2,2	al ml W9TL205
1	Basamento in metallo L 360 H 13 P 48	W9ZG03603
2	Montante "idro" H 120 dx/sx	5BFLBI60D/S
2	Montante "idro" H 36 dx/sx	5BFLBI10D/S
2	Montante "idro" H 36 centrale	5BFLBI10C
5	Mensola impiallacciata L 81 P 32 spessore 2,2	al ml W9I623
3	Mensola impiallacciata L 87 P 32 spessore 2,2	al ml W9I623

No. of ELEMENTS	DESCRIPTION	CODE
3	Wall unit W 90 H 36 D 34,4, 1 glass flap door, push-pull opening	WPVF10900
4	Living base unit W 90 H 36 D 50,4, 1 deep drawer	WLB10900
2	Lacquered worktop W 180 D 51 TH.2,2	per lm W9TL205
1	Metal base W 360 H 13 D 48	W9ZG03603
2	"Idro" pillar H 120 RH/LH	5BFLBI60D/S
2	"Idro" pillar H 36 RH/LH	5BFLBI10D/S
2	"Idro" pillar H 36 central	5BFLBI10C
5	Veneered shelf W 81 D 32 TH.2,2	per lm W9I623
3	Veneered shelf W 87 D 32 TH.2,2	per lm W9I623

LIVING 04



ANTA
door

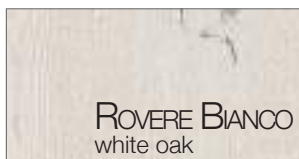

ELEMENTI A GIORNO
open units



STRUTTURA
carcass



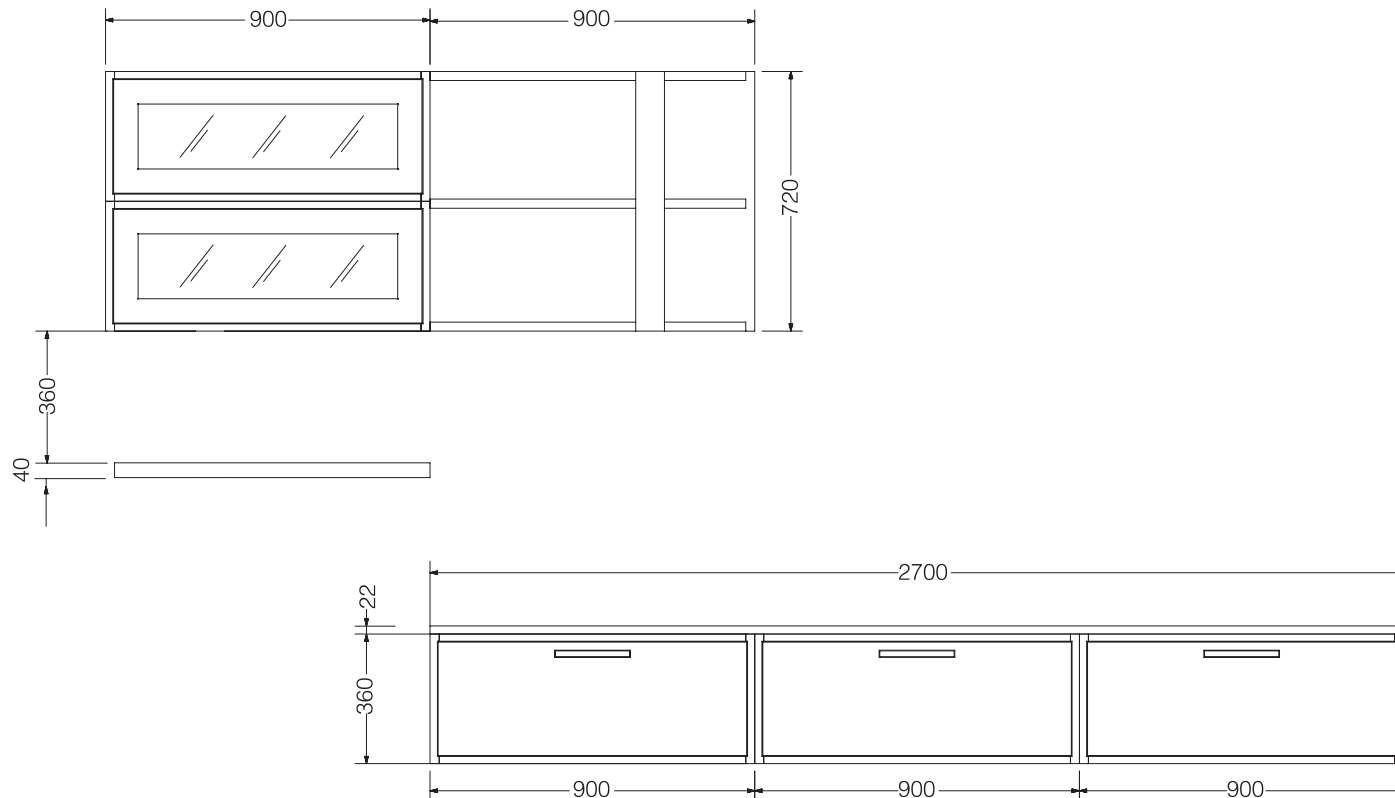

NR. ELEMENTI	DESCRIZIONE	CODICE
1	Pensile L 90 H 72 P 34,4, 2 ante vetro ribalta apertura push pull, fianchi laccati	WPVS40900
2	Base living sospesa L 90 H 36 P 50,4, 1 cestone, 1 fianco laccato	WLSB10900
1	Base living sospesa L 90 H 36 P 50,4, 1 cestone	WLSB10900
1	Elemento a giorno "tipo 2" L 90 H 72 P 32 laccato	WMDA40901
1	Mensola laccata L 90 P 32 spessore 4	al ml W9L603
1	Top laccato L 270 P 51 spessore 2,2	al ml W9TL205
No. of ELEMENTS	DESCRIPTION	CODE
1	Wall unit W 90 H 72 D 34,4, 2 glass flap doors push-pull opening, lacquered sides	WPVS40900
2	Hanging living base unit W 90 H 36 D 50,4, 1 deep drawer, 1 lacquered side	WLSB10900
1	Hanging living base unit W 90 H 36 D 50,4, 1 deep drawer	WLSB10900
1	"Type 2" lacquered open unit W 90 H 72 D 32	WMDA40901
1	Lacquered shelf W 90 D 32 TH.4	per lm W9L603
1	Lacquered worktop W 270 D 51 TH.2,2	per lm W9TL205

LIVING 05



ANTA
door

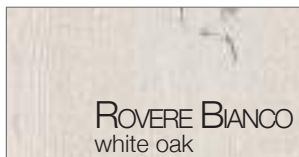

STRUTTURA
carcass



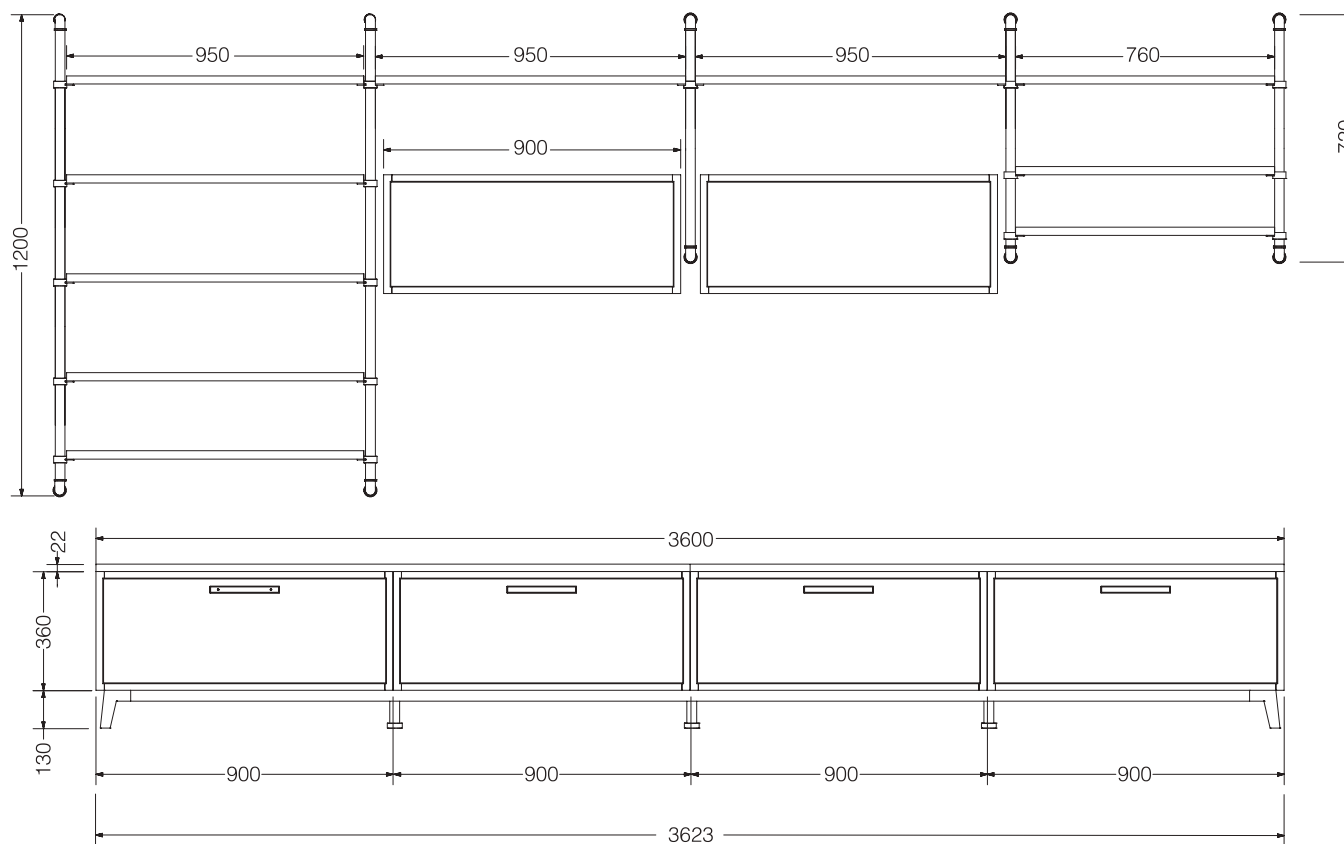

NR. ELEMENTI	DESCRIZIONE	CODICE
2	Pensile L 90 H 36 P 34,4, 1 anta ribalta, apertura push pull	WPF10900
4	Base living L 90 H 36 P 50,4, 1 cestone	WLB10900
2	Top impiallacciato L 180 P 51 spessore 2,2	al ml W9TI205
1	Basamento in metallo L 360 H 13 P 48	W9ZG03603
2	Montante "idro" H 120 dx/sx	5BFLBI60D/S
2	Montante "idro" H 72 centrale	5BFLBI40C
1	Montante "idro" H 72 dx	5BFLBI40D
7	Mensola impiallacciata L 94 P 32 spessore 2,2	al ml W9I623
3	Mensola impiallacciata L 76 P 32 spessore 2,2	al ml W9I623
No. of ELEMENTS	DESCRIPTION	CODE
2	Wall unit W 90 H 36 D 34,4, 1 flap door, push-pull opening	WPF10900
4	Living base unit W 90 H 36 D 50,4, 1 deep drawer	WLB10900
2	Veneered worktop W 180 D 51 TH.2,2	per lm W9TI205
1	Metal base W 360 H 13 D 48	W9ZG03603
2	"Idro" pillar H 120 RH/LH	5BFLBI60D/S
2	"Idro" pillar H 72 central	5BFLBI40C
1	"Idro" pillar H 72 RH	5BFLBI40D
7	Veneered shelf W 94 D 32 TH.2,2	per lm W9I623
3	Veneered shelf W 76 D 32 TH.2,2	per lm W9I623

LIVING 06



ANTE
doors

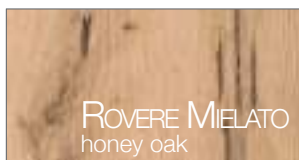

ROVERE MIELATO
honey oak



BIANCO CONCHIGLIA
shell white

STRUTTURE
carcasses



CARBON
carbon



BIANCO PERLA
pearl white

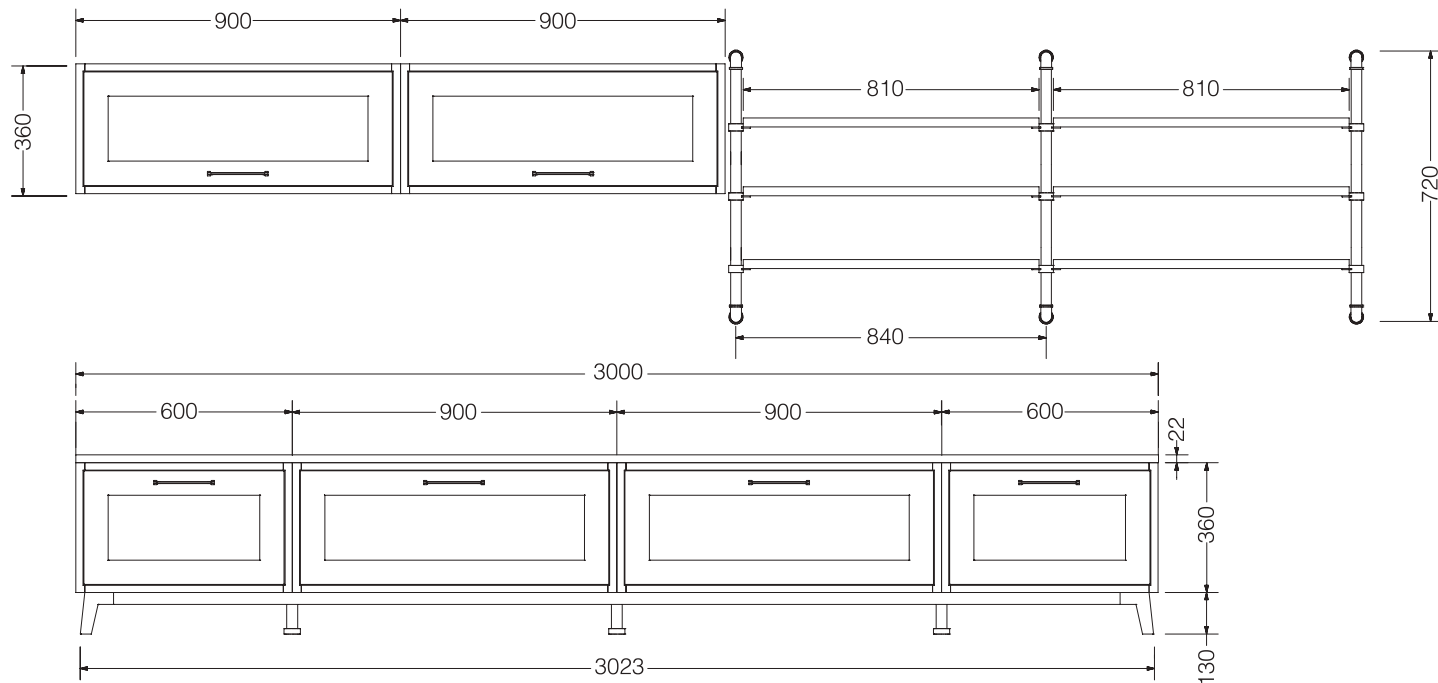

NR. ELEMENTI	DESCRIZIONE	CODICE
2	Pensile L 90 H 36 P 34,4, 1 anta ribalta	WPF10900
2	Base living L 60 H 36 P 48, 1 cestone	WLB10600
2	Base living L 90 H 36 P 48, 1 cestone	WLB10900
1	Top impiallacciato L 300 P 51 spessore 2,2	al ml W9TI205
1	Basamento in metallo L 300 H 13 P 48	W9ZG03003
2	Montante "idro" H 72 dx/sx	5BFLBI40D/S
1	Montante "idro" H 72 centrale	5BFLBI40C
6	Mensola impiallacciata L 81 P 32 spessore 2,2	al ml W9I623
No. of ELEMENTS	DESCRIPTION	CODE
2	Wall unit W 90 H 36 D 34,4, 1 flap door	WPF10900
2	Living base unit W 60 H 36 D 48, 1 deep drawer	WLB10600
2	Living base unit W 90 H 36 D 48, 1 deep drawer	WLB10900
1	Veneered worktop W 300 D 51 TH.2,2	per lm W9TI205
1	Metal base W 300 H 13 D 48	W9ZG03003
2	"Idro" pillar H 72 RH/LH	5BFLBI40D/S
1	"Idro" pillar H 72 central	5BFLBI40C
6	Veneered shelf W 81 D 32 TH.2,2	per lm W9I623

LIVING 07



ANTA
door

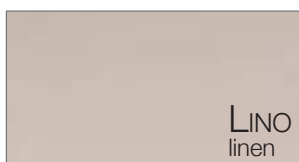

LINO
linen

STRUTTURA
carcass



CENERE
ash

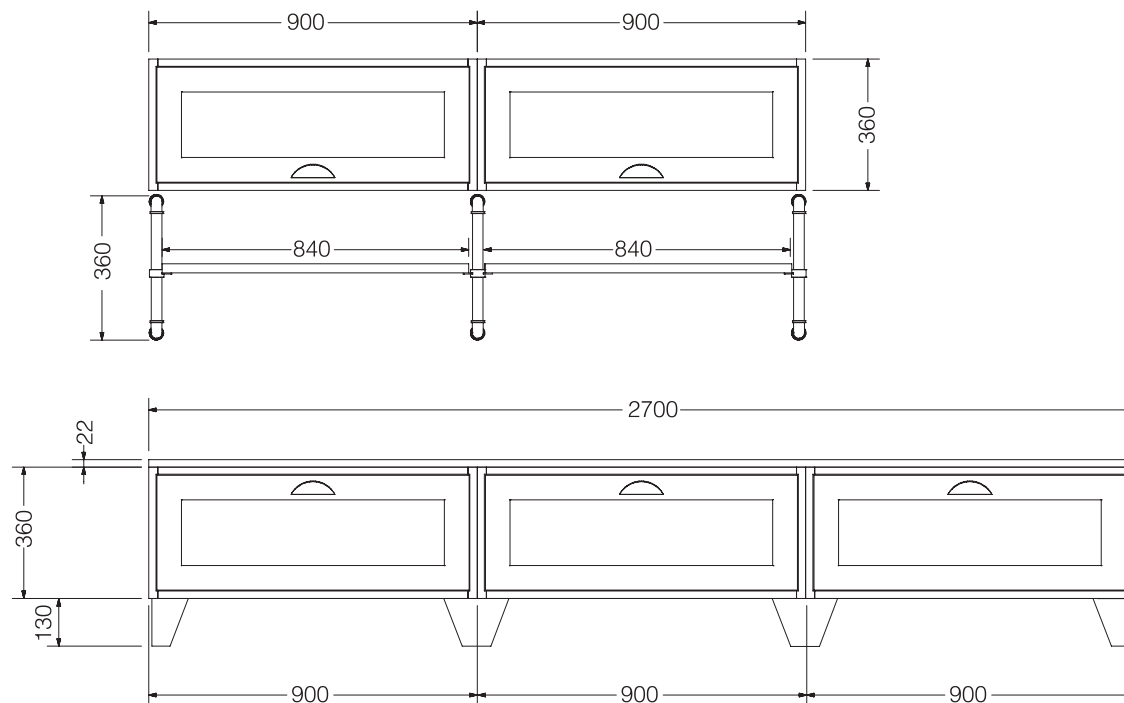

NR. ELEMENTI	DESCRIZIONE	CODICE
2	Pensile L 90 H 36 P 34,4, 1 anta ribalta, 1 fianco come anta	WPF10900
2	Base living L 90 H 36 P 50,4, 1 cestone, 1 fianco come anta	WLB10900
1	Base living L 90 H 36 P 50,4, 1 cestone	WLB10900
1	Top laccato L 270 P 51 spessore 2,2	al ml W9TL205
2	Montante "idro" H 36 dx/sx	5BFLBI10D/S
1	Montante "idro" H 36 centrale	5BFLBI10C
2	Mensola laccata L 84 P 32 spessore 2,2	al ml W9L623
4	Piede living legno H 13 laccato, laterale	5BPLL01
4	Piede living legno H 13 laccato, centrale	5BPLL05
No. of ELEMENTS	DESCRIPTION	CODE
2	Wall unit W 90 H 36 D 34,4, 1 flap door, 1 side same as door	WPF10900
2	Living base unit W 90 H 36 D 50,4 1 deep drawer, 1 side same as door	WLB10900
1	Living base unit W 90 H 36 D 50,4 1 deep drawer	WLB10900
1	Lacquered worktop W 270 D 51 TH.2,2	per lm W9TL205
2	"Idro" pillar H 36 RH/LH	5BFLBI10D/S
1	"Idro" pillar H 72 central	5BFLBI10C
2	Lacquered shelf W 84 D 32 TH.2,2	per lm W9L623
4	Wooden lacquered foot H 13, lateral	5BPLL01
4	Wooden lacquered foot H 13, central	5BPLL05

COMPLEMENTI

COMPLEMENTS

- **Bancone isola “BREAK”**
“BREAK” island counter
- **Mobili di complemento laccati**.....
Lacquered furniture complements
- **Sostegno penisola “MOST”**.....
“MOST” peninsula support
- **Sostegno penisola “ILAN”**
“ILAN” peninsula support
- **Elemento pensile a giorno**.....
Open wall unit
- **Sopra isola “ISLA”**.....
“ISLA” hanging shelf above island
- **“IDRO”**
“IDRO”
- **Boiserie “HOLE”**
“HOLE” boiserie
- **Luci “ITAL PEK”**
“ITAL PEK” lights
- **Tavolo “DUBLE”**
“DOUBLE” table
- **Tavolo “PLAK”**.....
“PLAK” table
- **Tavolo “MASTER”**
“MASTER” table

BANCONE ISOLA "BREAK" IMPIALLACCIATO CON SUPPORTI IN FERRO SP.5 CM
"BREAK" VENEERED ISLAND COUNTER WITH TH.5 CM IRON SUPPORTS



Bancone isola "BREAK" impiallacciato frassino con 3 cassetti e supporti in ferro color grafite
"BREAK" ash veneered island counter with 3 drawers and graphite colour iron supports

CODICE / CODE No.

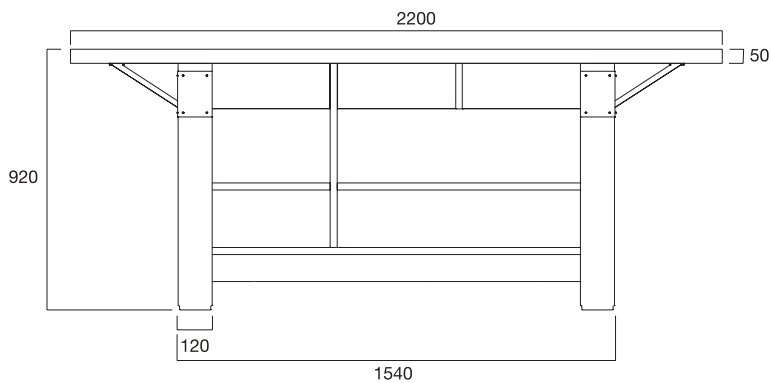

Colori disponibili
 Available colours



frassino mielato
 honey ash



frassino bianco
 white ash

Frassino Mielato
 Honey ash
L 2200 H 920 P 900
 W 2200 H 920 D 900

08BP20FMIE

Frassino Bianco
 White ash
L 2200 H 920 P 900
 W 2200 H 920 D 900

08BP20FBIA

MOBILI DI COMPLEMENTO LACCATI

LACQUERED FURNITURE COMPLEMENTS



Mobile di complemento laccato nei colori: bianco conchiglia (opz.W720), mandorla (opz.W820), lino (opz.W770), carbon (opz.W920), coloniale (W870), rosso toscano (opz.8157), blu borgo (opz.W830)

Complement cabinet, available in the following lacquered colours: shell white (opt.W720), almond (opt.W820), linen (opt.W770), carbon (opt.W920), colonial (opt.W870), tuscan red (opt.8157), borgo blue (opt.W830)

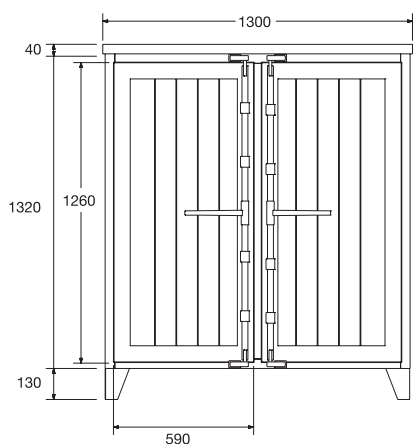

Colori laccati

Lacquered colours

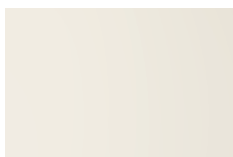

bianco conchiglia (opz.W720)
shell white (opt.W720)



mandorla (opz.W820)
almond (opt.W820)



lino (opz.W770)
linen (opt.W770)



carbon (opz.W920)
carbon (opt.W920)



coloniale (opz.W870)
colonial (opt.W870)



rosso toscano (opz.8157)
tuscan red (opt.8157)



blu borgo (opz.W830)
borgo blue (opt.W830)

Ghiacciaia/Dispensa per frigo It 215 DX-SX, 2 ante fresate H 1260

Ice box/Pantry for 215 fridge-RH or LH, 2 grooved doors H 1260
L 1300 H 1490 P 630
W 1300 H 1490 D 630

WMGD71301/2

Mobile/ Dispensa, 2 ante fresate H 1260

Furniture/Pantry, 2 grooved doors H 1260
L 1300 H 1490 P 630
W 1300 H 1490 D 630

WMGD71300

CODICE / CODE No.

SOSTEGNO PENISOLA "MOST" LACCATO CON INSERTI IN FERRO GRAFITE "MOST" LACQUERED PENINSULA SUPPORT WITH GRAPHITE IRON INSERTS



Sostegno penisola "MOST" laccato con inserti in ferro color grafite, regolabile in larghezza min.L 600 - max. L 900, laccato nei colori: bianco conchiglia (opz.W720), mandorla (opz.W820), lino (opz.W770), carbon (opz.W920), coloniale (opz.W870)

"MOST" lacquered peninsula support with graphite iron insert, adjustable width (min.W 600-max.W900).

Available in the following colours:
shell white (opt.W720), almond (opt.W820), linen (opt.W770), carbon (opt.W920), colonial (opt.W870)

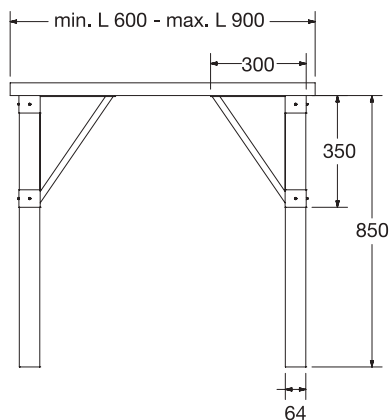

Colori laccati

Lacquered colours



bianco conchiglia (opz.W720)
shell white (opt.W720)



mandorla (opz.W820)
almond (opt.W820)



lino (opz.W770)
linen (opt.W770)



carbon (opz.W920)
carbon (opt.W920)



coloniale (opz.W870)
colonial (opt.W870)

min. L 600 - max. L 900
min.W 600 - max.W 900

CODICE / CODE No.

0879094B

SOSTEGNO PENISOLA "ILAN" CON BARRA MULTIUSO ACCIAIO

"ILAN" PENINSULA SUPPORT WITH MULTIPORPOSE STEEL BAR



Sostegno penisola "ILAN" con barra multiuso in acciaio, laccato nei colori: bianco conchiglia (opz.W720), mandorla (opz.W820), lino (opz.W770), carbon (opz.W920), coloniale (opz.W870)
 "ILAN" peninsula support with multipurpose steel bar, available in the following lacquer colours: shell white (opt.W720), almond (opt.W820), linen (opt.W770), carbon (opt.W920), colonial (opt.W870)

CODICE / CODE No.

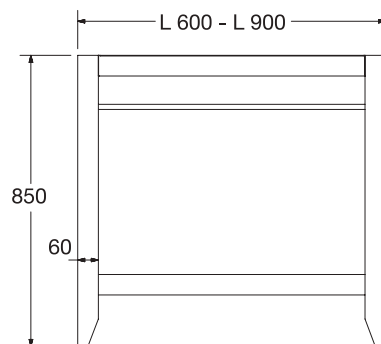

Colori laccati
Lacquered colours



bianco conchiglia (opz.W720)
shell white (opt.W720)



mandorla (opz.W820)
almond (opt.W820)



lino (opz.W770)
linen (opt.W770)



carbon (opz.W920)
carbon (opt.W920)



coloniale (opz.W870)
colonial (opt.W870)

L 600 W 600

L 900 W 900

0879094N

0879094P

ELEMENTO PENSILE A GIORNO IN FERRO

OPEN WALL UNIT IRON STRUCTURE



Elemento pensile a giorno con struttura in ferro verniciato, mensole e schienale laccato
N.B.: non comprensibile di pensile

Open wall unit with painted iron structure, lacquered shelves and back panel

Note: wall unit not included

CODICE / CODE No.

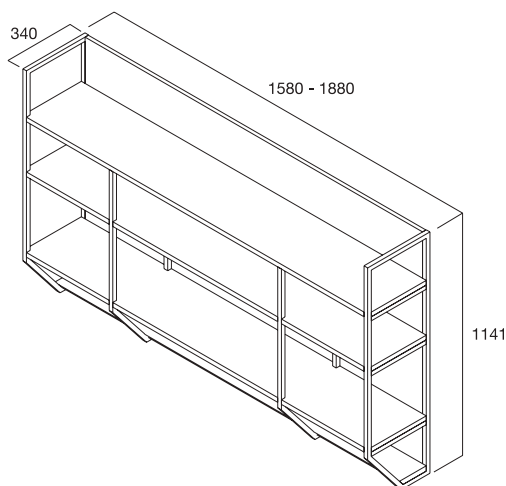

Colori laccati

Lacquered colours

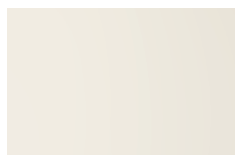

bianco conchiglia (opz.W720)
shell white (opt.W720)



mandorla (opz.W820)
almond (opt.W820)



lino (opz.W770)
linen (opt.W770)



carbon (opz.W920)
carbon (opt.W920)

Predisposto per pensile da 60 L 1580
for wall unit 60 W 1580

WMGB71650

Predisposto per pensile da 90 L 1880
for wall unit 90 W 1880

WMGB71850

SOPRA ISOLA “ISLA” LACCATA CON TIRANTI REGOLABILI A SOFFITTO
“ISLA” HANGING LACQUERED SHELF ABOVE ISLAND WITH CEILING ADJUSTABLE RODS



Sopra isola “ISLA” laccata con tiranti in acciaio regolabili, fissati a soffitto con 2 barre multiuso cromate
 “ISLA” lacquered shelf with ceiling adjustable rods, fixed with 2 multipurpose chromed bars

CODICE / CODE No.

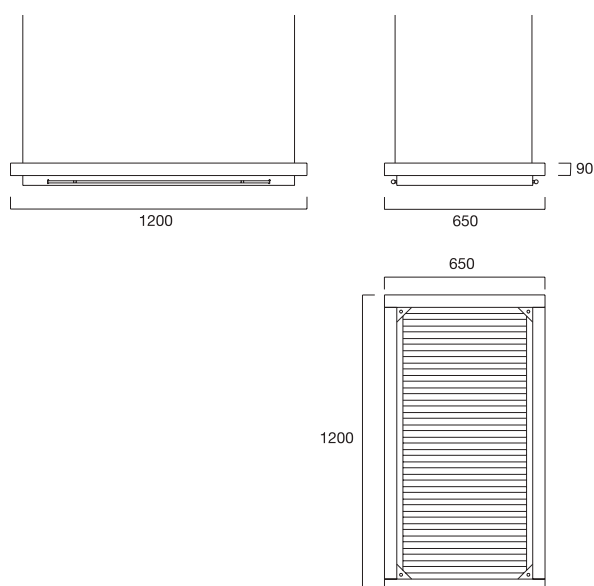

Colori laccati
 Lacquered colours

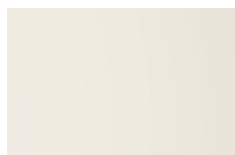

bianco conchiglia (opz.W720)
 shell white (opt.W720)



mandorla (opz.W820)
 almond (opt.W820)



lino (opz.W770)
 linen (opt.W770)



carbon (opz.W920)
 carbon (opt.W920)



coloniale (opz.W870)
 colonial (opt.W870)

WMGE80900

“IDRO”
“IDRO”



Elemento DX e SX comprensivi di reggimensola
Each element is equipped with shelf holder

CODICE / CODE No.

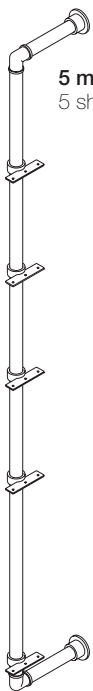

5 mensole
5 shelves

H 1800

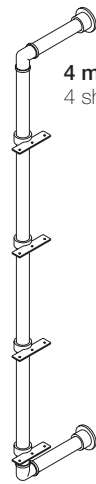

4 mensole
4 shelves

H 1200

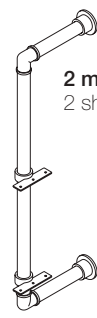

2 mensole
2 shelves

H 720



2 mensole
2 shelves

H 600

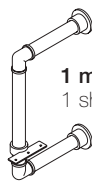

1 mensola
1 shelf

H 360

H 1800
H 1200
H 720
H 600
H 360

W89LB180D/S
W89LB160D/S
W89LB140D/S
W89LB130D/S
W89LB110D/S

“IDRO”

“IDRO”

Elemento centrale comprensivo di reggimensola
Central element equipped with shelf holder

CODICE / CODE No.

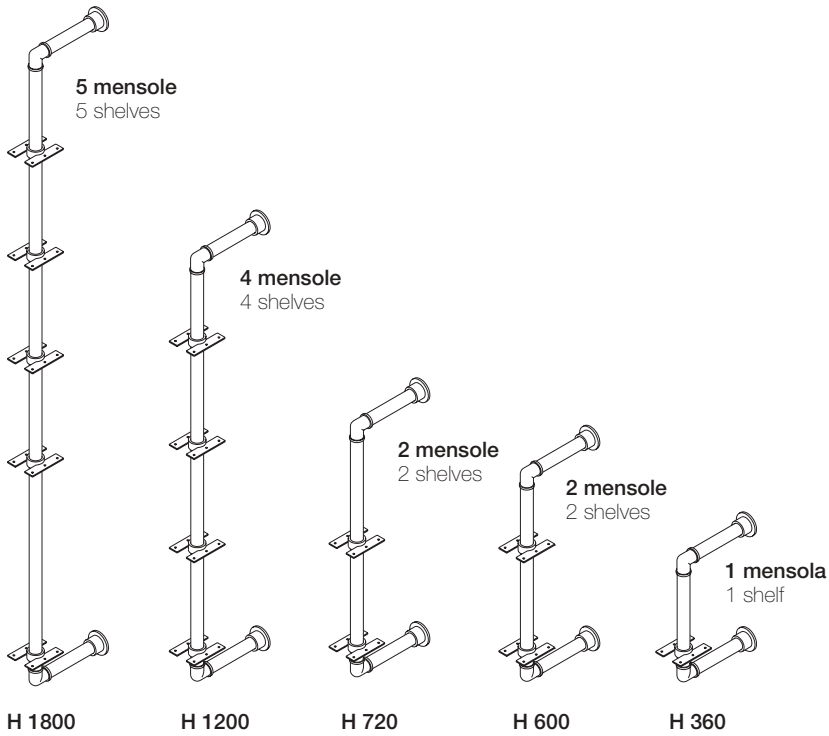

H 1800
H 1200
H 720
H 600
H 360

W89LB180C
W89LB160C
W89LB140C
W89LB130C
W89LB110C

Reggimensola DX e SX
Right and Left shelf holder

N.B.: necessario solo in caso di inserimento mensole in aggiunta a quelle di serie
Note: only necessary in case of shelves inserted in addition to the standard ones

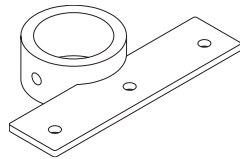

cadauno
each

W89LB197

Reggimensola centrale
Central shelf holder

N.B.: necessario solo in caso di inserimento mensole in aggiunta a quelle di serie
Note: only necessary in case of shelves inserted in addition to the standard ones

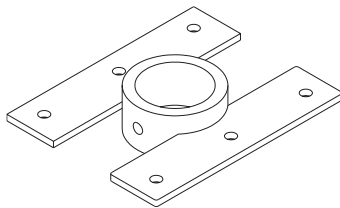

cadauno
each

W89LB195

Mensole SP. 22 P. 320
Shelves Th.22 D.320



Impiallacciata Veneered
Rovere Mielato
honey oak
Rovere Bianco
white oak
Rovere Grigio Terra
earth grey oak
Noce Canaletto
canaletto walnut

W9I623W520

W9I623W525

W9I623W530

W9I623W120

Laccata Lacquered
Bianco Conchiglia
shell white
Mandorla
almond
Lino
linen
Carbon
carbon
Coloniale
colonial

W9L623W720

W9L623W820

W9L623W770

WLI623W920

WLI623W870

BOISERIE "HOLE"

"HOLE" BOISERIE



Colori disponibili

Available colours



silver dark
dark silver



grafite
graphite

BOISERIE "HOLE"

"HOLE" BOISERIE

Boiserie in acciaio verniciato H 240 SP. 20
Painted steel boiserie H 240 Th.20

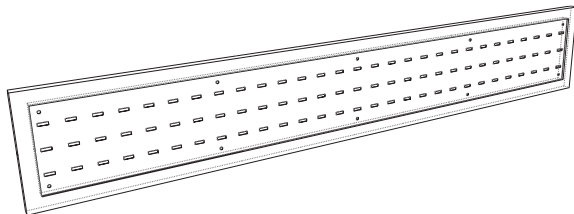

Silver Dark

L 900

L 1200

L 1500

W89LB109B

W89LB112B

W89LB115B

Grafite Graphite

L 900

L 1200

L 1500

W89LB109G

W89LB112G

W89LB115G

CODICE / CODE No.

Boiserie in acciaio verniciato H 360 SP. 20
Painted steel boiserie H 360 Th.20

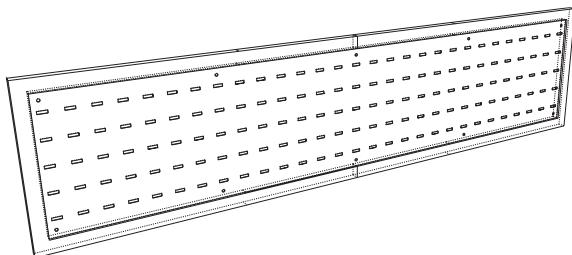

Silver Dark

L 900

L 1200

L 1500

W89LB309B

W89LB312B

W89LB315B

Grafite Graphite

L 900

L 1200

L 1500

W89LB309G

W89LB312G

W89LB315G

Boiserie in acciaio verniciato H 480 SP. 20
Painted steel boiserie H 480 Th.20

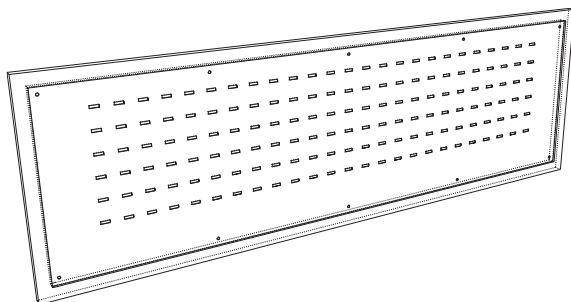

Silver Dark

L 900

L 1200

L 1500

W89LB509B

W89LB512B

W89LB515B

Grafite Graphite

L 900

L 1200

L 1500

W89LB509G

W89LB512G

W89LB515G

ACCESSORI "HOLE"

"HOLE" ACCESSORIES

Mensola L 320 P 120 in alluminio verniciato
Painted aluminum shelf W 320 D 120

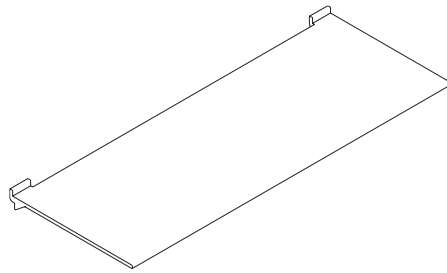

Silver Dark
Grafite Graphite

CODICE / CODE No.

W89LB802B
W89LB802G

Portarotolo L 320 P 123 in alluminio verniciato con corpo in legno
Painted aluminum roll holder with wooden body W 320 D 123

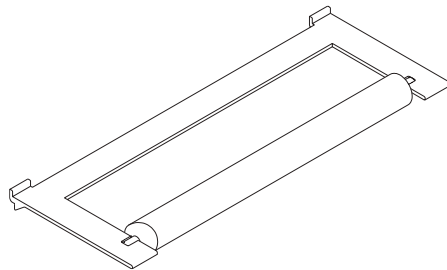

Silver Dark
Grafite Graphite

W89LB804B
W89LB804G

Portaspezie L 320 P 120 in alluminio verniciato
Painted aluminum spice holder W 320 D 120

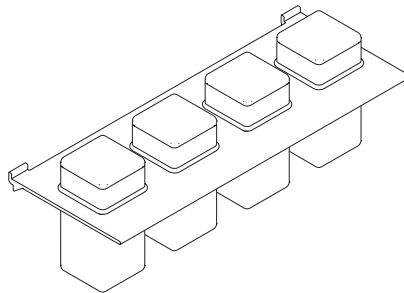

Silver Dark
Grafite Graphite

W89LB806B
W89LB806G

Set di 3 ganci L 120 alluminio verniciato
Kit with 3 painted aluminum hooks W 120

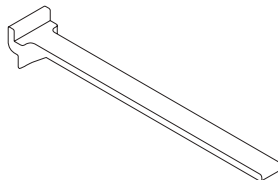

Silver Dark
Grafite Graphite

W89LB808B
W89LB808G

Set di 3 ganci L 25 alluminio verniciato
Kit with 3 painted aluminum hooks W 25



Silver Dark
Grafite Graphite

W89LB810B
W89LB810G

ACCESSORI "HOLE"

"HOLE" ACCESSORIES

Porta tablet L 320 P 120 in alluminio verniciato
Painted aluminum tablet holder W 320 D 120

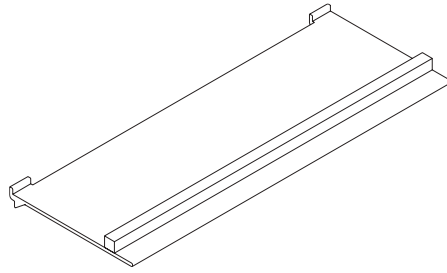

Silver Dark

CODICE / CODE No.

W89LB812B

Grafite Graphite

W89LB812G

Provenza MICRO_sotto pensile *under wall units*

ITAL PEK
ATELIER LED LIGHTING

N.b.: per fianchi struttura sp.25 mm

Note: for carcass sides th.25 mm



Caratteristiche tecniche

diffusore	policarbonato opalino
fissaggio	a pressione e/o con gocce di adesivo
lunghezza profilo	da 399mm a 849mm
LED	STRIP-LED 180 LED/m 14 W/m
colore luce temperatura	luce naturale_4000 K +/- 200 K
alimentazione	24V - DC
lunghezza cavo	cavetto 300mm + cavo da 2800mm con connettori
caratteristica	luce continua, senza interruzioni
certificazione fotobiologica	classe 0
resa cromatica	CRI>80

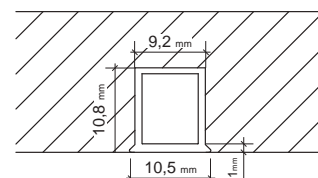

Technical features

<i>diffuser</i>	<i>opal polycarbonate</i>
<i>fastening</i>	<i>press fitting and/or with some glue drops</i>
<i>profile length</i>	<i>from 399 mm up to 849 mm</i>
<i>LED</i>	<i>STRIP-LED 180 LED/m 14 W/m</i>
<i>colour temperature</i>	<i>natural white_4000 K +/- 200 K</i>
<i>power supply</i>	<i>24V - DC</i>
<i>cable length</i>	<i>300mm cable + 2800mm extension cable</i>
<i>light features</i>	<i>uniform and seamless light</i>
<i>photobiological safety</i>	<i>RG (risk group) 0</i>
<i>chromaticity Index</i>	<i>CRI>80</i>



CODICE ITEM CODE	DESCRIZIONE DESCRIPTION	    	LUNGH mm LENGTH mm	WATT/h	VOLT
08616110B	MICRO 399mm L.NEUTRA/NATURAL WHITE - TOUCH BUTTON		399	6	24 V
08616112B	MICRO 549mm L.NEUTRA/NATURAL WHITE - TOUCH BUTTON		549	8	24 V
08616114B	MICRO 849mm L.NEUTRA/NATURAL WHITE - TOUCH BUTTON		849	12	24 V

VERSIONE UL LISTED per Stati Uniti e Canada - File E364009

CODICE ITEM CODE	DESCRIZIONE DESCRIPTION	    	LUNGH mm LENGTH mm	WATT/h	VOLT
08616111B	UL - MICRO 399mm L.NEUTRA/NATURAL WHITE -TOUCH BUTTON		399	6	24 V
08616113B	UL - MICRO 549mm L.NEUTRA/NATURAL WHITE -TOUCH BUTTON		549	8	24 V
08616115B	UL - MICRO 849mm L.NEUTRA/NATURAL WHITE -TOUCH BUTTON		849	12	24 V



I prezzi indicati comprendono un cavo di collegamento L.280cm al trasformatore
The above prices include a 280cm connecting cable to the power supply

**IMPORTANTE: ALIMENTATORI NON INCLUSI,
DA ORDINARE SEPARATAMENTE**

Scegliere l'alimentatore in relazione al consumo totale in Watt delle lampade LED. Si consiglia di tenere un margine di sicurezza di circa 10% rispetto alla potenza massima del trasformatore.

**IMPORTANT NOTICE - POWER SUPPLIES
NOT INCLUDED - TO BE ORDERED SEPARATELY**

Please choose the adequate power supply considering the total power consumption in Watt. It is recommended to keep a 10% safety margin below the maximum power output of the power supply.

					
CODICE ITEM CODE	08616190	CODICE ITEM CODE	08616192	CODICE ITEM CODE	08616194
VOLT	220-240 Vac/24V	VOLT	220-240 Vac/24V	VOLT	220-240 Vac/24V
MAX WATT	20W (0,84 A)	MAX WATT	50W (2,8 A)	MAX WATT	75W (3,1 A)
				PREZZO UNIT PRICE	

TOUCH BUTTON

Il touch button è di tipo capacitivo e funziona al rilascio del dito. Memorizza l'ultima posizione impostata. Dopo un black-out la lampada ritorna nella stessa posizione in cui si trovava prima dello spegnimento.

A lampada spenta una luce LED identifica la posizione del touch button. La luce blu si spegne a lampada accesa.

TOUCH BUTTON CON DIMMERAZIONE FISSA

- 1 - toccando il touch button la lampada si accende al 100% dell'intensità;
- 2 - toccando di nuovo il touch button la luminosità si riduce del 50%
- 3 - toccando il touch button la lampada si spegne.

Tutte le nostre lampade con touch button possono essere comandate da un interruttore esterno.

TOUCH BUTTON

The touch button is capacitive, and works on release. It saves the last position set. After a power cut, the lamp returns to the same position as before the interruption. When the lamp is off, a small LED light indicates the position of the touch button. The LED signal goes off when the lamp is turned on.

3 STEP DIMMING

- 1 - touching the diffuser where LED/spring are visible, light turns on at 100% of its brightness;
- 2 - touching the diffuser again the brightness is reduced by 50%
- 3 - touching the diffuser light turns off.

All our lighting units with touch button can be turned on and off by an external switch.

Il valore in LUX indicato è riferito ad una barra L=1200mm
Values in Lux refer to 1200 mm long lighting units

versione STRIP 180L 14 W/metro

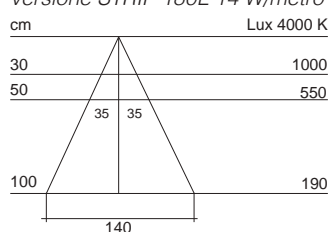



ITAL PEK s.r.l. **MICRO**

 questo dispositivo è munito di lampade a LED integrate

 } LED

le lampade di questo dispositivo non sono sostituibili

874/2012 

MADE IN ITALY 

Provenza MICRO12_x11 interno colonne e pensili

inside tall units and wall units

ITAL PEK
ATELIER LED LIGHTING

N.b.: per fianchi struttura sp.25 mm

Note: for carcass sides th.25 mm



Caratteristiche tecniche

diffusore	policarbonato opalino
fissaggio	a pressione e/o con gocce di adesivo
lunghezza profilo	vedi tabella
LED	STRIP-LED 180 LED/m 10 W/m
colore luce temperatura	luce naturale_4000 K +/- 200 K
alimentazione	24V - DC
lunghezza cavo	cavetto 300mm + cavo da 1800mm con connettori
caratteristica	luce continua, senza interruzioni
certificazione fotobiologica	classe 0
resa cromatica	CRI>80

Technical features

diffuser	opal polycarbonate
fastening	press fitting and/or with some glue drops
profile length	see chart
LED	STRIP-LED 180 LED/m 10 W/m
colour temperature	natural white_4000 K +/- 200 K
power supply	24V - DC
cable length	300mm cable + 1800mm extension cable
light features	uniform and seamless light
photobiological safety	RG (risk group) 0
chromaticity Index	CRI>80



fianco sinistro
left side



fianco destro
right side

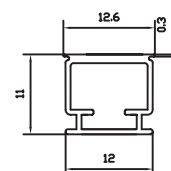

CODICE ITEM CODE FIANCO DESTRO RIGHT SIDE	CODICE ITEM CODE FIANCO SINISTRO LEFT SIDE	DESCRIZIONE DESCRIPTION	CE III F IP44	H PENSILE /COLONNA mm H CABINET mm	WATT/h	VOLT
08616150DB	08616150SB	MICRO 12X11 323 mm 4000 K SENSORE PIR / PIR SENSOR		360	3	24 V
08616152DB	08616152SB	MICRO 12X11 643 mm 4000 K SENSORE PIR / PIR SENSOR		480	4	24 V
08616154DB	08616154SB	MICRO 12X11 563 mm 4000 K SENSORE PIR / PIR SENSOR		600	5	24 V
08616156DB	08616156SB	MICRO 12X11 683 mm 4000 K SENSORE PIR / PIR SENSOR		720	6	24 V
08616158DB	08616158SB	MICRO 12X11 923 mm 4000 K SENSORE PIR / PIR SENSOR		960	9	24 V
08616164DB	08616164SB	MICRO 12X11 1283 mm 4000 K SENSORE PIR / PIR SENSOR		1320	12,5	24 V
08616168DB	08616168SB	MICRO 12X11 2003 mm 4000 K SENSORE PIR / PIR SENSOR		2040	19,5	24 V
08616172DB	08616172SB	MICRO 12X11 2243 mm 4000 K SENSORE PIR / PIR SENSOR		2280	22	24 V

CODICE ITEM CODE FIANCO DESTRO RIGHT SIDE	CODICE ITEM CODE FIANCO SINISTRO LEFT SIDE	DESCRIZIONE DESCRIPTION	UL III F IP44	H PENSILE /COLONNA mm H CABINET mm	WATT/h	VOLT
08616151DB	08616151SB	MICRO 12X11 323 mm 4000 K SENSORE PIR / PIR SENSOR		360	3	24 V
08616153DB	08616153SB	MICRO 12X11 643 mm 4000 K SENSORE PIR / PIR SENSOR		480	4	24 V
08616155DB	08616155SB	MICRO 12X11 563 mm 4000 K SENSORE PIR / PIR SENSOR		600	5	24 V
08616157DB	08616157SB	MICRO 12X11 683 mm 4000 K SENSORE PIR / PIR SENSOR		720	6	24 V
08616159DB	08616159SB	MICRO 12X11 923 mm 4000 K SENSORE PIR / PIR SENSOR		960	9	24 V
08616165DB	08616165SB	MICRO 12X11 1283 mm 4000 K SENSORE PIR / PIR SENSOR		1320	12,5	24 V
08616169DB	08616169SB	MICRO 12X11 2003 mm 4000 K SENSORE PIR / PIR SENSOR		2040	19,5	24 V
08616173DB	08616173SB	MICRO 12X11 2243 mm 4000 K SENSORE PIR / PIR SENSOR		2280	22	24 V



I prezzi indicati comprendono un cavo di collegamento L.180cm al trasformatore
The above prices include a 180cm connecting cable to the power supply

**IMPORTANTE: ALIMENTATORI NON INCLUSI,
DA ORDINARE SEPARATAMENTE**

Scegliere l'alimentatore in relazione al consumo totale in Watt delle lampade LED. Si consiglia di tenere un margine di sicurezza di circa 10% rispetto alla potenza massima del trasformatore.

**IMPORTANT NOTICE - POWER SUPPLIES
NOT INCLUDED - TO BE ORDERED SEPARATELY**

Please choose the adequate power supply considering the total power consumption in Watt. It is recommended to keep a 10% safety margin below the maximum power output of the power supply.

					
CODICE ITEM CODE	08616190	CODICE ITEM CODE	08616192	CODICE ITEM CODE	08616194
VOLT	220-240 Vac/24V	VOLT	220-240 Vac/24V	VOLT	220-240 Vac/24V
MAX WATT	20W (0,84 A)	MAX WATT	50W (2,8 A)	MAX WATT	75W (3,1 A)

Il valore in LUX indicato è riferito ad una barra L=1200mm
Values in Lux refer to 1200 mm long lighting units

versione STRIP 180L 10 W/metro

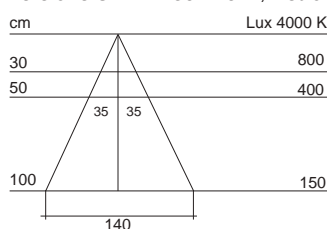

ITAL PEK s.r.l. MICRO

questo dispositivo è munito di lampade a LED integrate

A+ A A C D E } LED

le lampade di questo dispositivo non sono sostituibili

874/2012

MADE IN ITALY



DUBLE

TAVOLO / TABLE

TAVOLO "DUBLE" ALLUNGABILE CON PROLUNGHE
GAMBE 6X6

STRUTTURA IN METALLO VERNICIATA

PIANO SP.4, DISPONIBILE NELLE VERSIONI LACCATE E IMPIALLACCIATE
CON O SENZA INSERTI IN METALLO, VERNICIATI GRAFITE

"DUBLE" EXTENDABLE TABLE WITH EXTENSIONS

LEGS CM 6X6

PAINTED METAL STRUCTURE

TH.4 CM TOP AVAILABLE IN THE VENEERED AND LACQUERED VERSIONS

WITH OR WITHOUT GRAPHITE METAL INSERTS

122 X 70 H 79 N.2 PROLUNGHE DA 40

122 X 70 H 79 N.2 EXTENSIONS CM 40

140 X 80 H 79 N.2 PROLUNGHE DA 50

140 X 80 H 79 N.2 EXTENSIONS CM 50

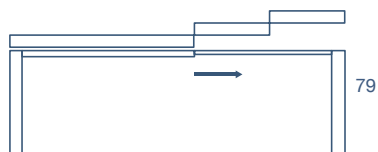

122-202

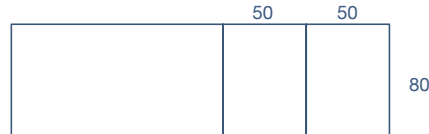
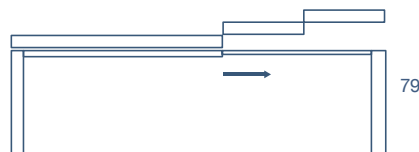

140-240

DUBLE



SEDIA OLA
WITH OLA CHAIR

STRUTTURA METALLO
METAL STRUCTURE



METALLO
METAL



LACCATO
LACQUERED



IMPIALLACCIATO
VENEERED



FINITURE STRUTTURA METALLO VERNICIATO

PAINTED METAL STRUCTURE FINISHES



Bianco Conchiglia (opz.W720)
Seashell White



Coloniale (opz.W870)
Colonial



Lino (opz.W770)
Flaxseed



Mandorla (opz.W820)
Almond



Carbon (opz.W920)
Carbon

CODICE / CODE

DIMENSIONI / DIMENSIONS

08DU12T

Laccato 122 x 70 Allungabile 202 / Laquered 122 x 70 Extendable 202

08DU14T

Laccato 140 x 80 Allungabile 240 / Laquered 160 x 90 Extendable 240

08DU12W

Impiallacciato 122 x 70 Allungabile 202 / Veneered 122 x 70 Extendable 202

08DU14W

Impiallacciato 140 x 80 Allungabile 240 / Veneered 160 x 90 Extendable 240



FINITURE PIANO IMPIALLACCIATO FRASSINO TINTO

STAINED ASH VENEERED TOP FINISHES



Noce Canaletto (opz.W120)
Canaletto Walnut



Rovere Bianco (opz.W525)
White Oak



Rovere Mielato (opz.W520)
Honey Oak



Rovere Grigio Terra (opz.W530)
Earth grey stained

FINITURE PIANO LACCATO

LAQUERED TOP FINISHES

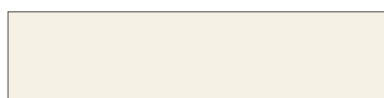

Bianco Conchiglia (opz.W720)
Seashell White



Mandorla (opz.W820)
Almond



Coloniale (opz.W870)
Colonial



Carbon (opz.W920)
Carbon



Lino (opz.W770)
Flaxseed



PLAK

TAVOLO / TABLE



TAVOLO "PLAK" ALLUNGABILE CON PROLUNGHE
GAMBE 9X9

STRUTTURA LACCATA O IMPIALLACCIATA
PIANO SP.5, DISPONIBILE NELLE VERSIONI LACCATE E IMPIALLACCIATE
CON O SENZA INSERTI IN METALLO, VERNICIATI GRAFITE

*"PLAK" EXTENDABLE TABLE WITH EXTENSIONS
LEGS CM 9X9*

VENEERED OR LACQUERED STRUCTURE

*TH.5 CM TOP AVAILABLE IN THE VENEERED AND LACQUERED VERSIONS
WITH OR WITHOUT GRAPHITE METAL INSERTS*

140 X 90 H 78 N.1 PROLUNGA DA 60

140 X 90 H 78 N.1 EXTENSION CM 60

160 X 90 H 78 N.1 PROLUNGA DA 60

160 X 90 H 78 N.1 EXTENSION CM 60

180 X 90 H 78 N.1 PROLUNGA DA 60

180 X 90 H 78 N.1 EXTENSION CM 60

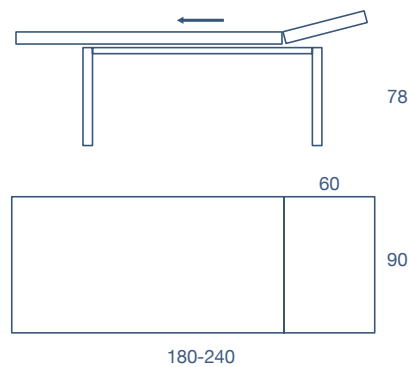
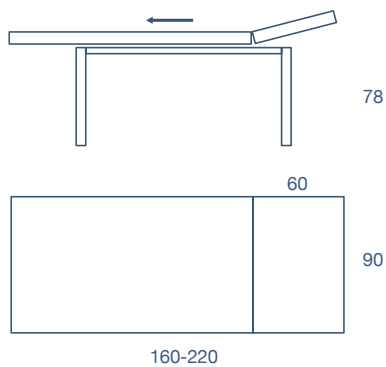
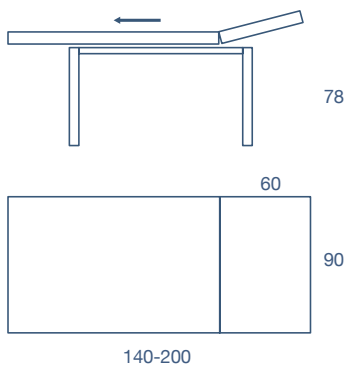

PLAK



STRUTTURA LEGNO
WOODEN STRUCTURE



LACCATO
LACQUERED



IMPIALLACCIATO
VENEERED



CODICE / CODE

DIMENSIONI / DIMENSIONS

08AP14T

Laccato 140 x 90 Allungabile 200 / Laquered 140 x 90 Extendable 200

08AP16T

Laccato 160 x 90 Allungabile 220 / Laquered 160 x 90 Extendable 220

08AP18T

Laccato 180 x 90 Allungabile 240 / Laquered 180 x 90 Extendable 240

08AP14W

Impiallacciato 140 x 90 Allungabile 200 / Veneered 140 x 90 Extendable 200

08AP16W

Impiallacciato 160 x 90 Allungabile 220 / Veneered 160 x 90 Extendable 220

08AP18W

Impiallacciato 180 x 90 Allungabile 240 / Veneered 180 x 90 Extendable 240



FINITURE IMPIALLACCiate FRASSINO TINTO

STAINED ASH VENEERED FINISHES



Noce Canaletto (opz.W120)
Canaletto Walnut



Rovere Bianco (opz.W525)
White Oak



Rovere Mielato (opz.W520)
Honey Oak



Rovere Grigio Terra (opz.W530)
Earth grey stained

FINITURE LACCATE

LACQUERED FINISHES



Bianco Conchiglia (opz.W720)
Seashell White



Mandorla (opz.W820)
Almond



Coloniale (opz.W870)
Colonial



Carbon (opz.W920)
Carbon



Lino (opz.W770)
Flaxseed



METALLO
METAL



FENIX



MELAMINICO
MELAMINE

MASTER

TAVOLO / TABLE

TAVOLO "MASTER" ALLUNGABILE CON PROLUNGA
STRUTTURA METALLO VERNICIATO
PIANO SP. 2,5 DISPONIBILE NELLE FINITURE FENIX E MELAMINICO

"MASTER" EXTENDABLE TABLE WITH EXTENSIONS
PAINTED METAL STRUCTURE
TH.2,5 CM TOP AVAILABLE IN THE FENIX AND MELAMINE FINISHES

140 X 90 H 75 N.1 PROLUNGA DA 50

140 X 90 H 75 N.1 EXTENSION CM 50

160 X 90 H 75 N.1 PROLUNGA DA 50

160 X 90 H 75 N.1 EXTENSION CM 50

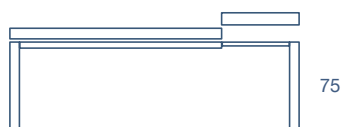

75

50



90

140 - 190



75

50

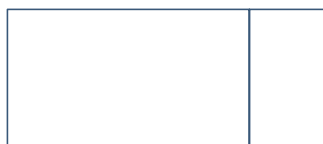

90

160 - 210

MASTER



SEDIA MASTER
WITH MASTER CHAIR

STRUTTURA METALLO
METAL STRUCTURE



METALLO
METAL



FENIX



MELAMINICO
MELAMINE



FINITURE STRUTTURA METALLO VERNICIATO SEMI OPACO

SEMI-MATT PAINTED METAL STRUCTURE FINISHES



bianco (opz.W)
white



nero (opz.F)
black

FINITURE PIANO MULTISTRATO PLACCATO FENIX

FENIX PLATED PLYWOOD TOP FINISHES



laminato fenix bianco (opz. FX5)
white fenix laminate



laminato fenix nero (opz. FX4)
black fenix laminate

FINITURE PIANO MELAMINICO NON SI ABBINANO AI MELAMINICI LUBE

MELAMINE TOP FINISHES DO NOT MATCH WITH THE LUBE MELAMINE FINISHES



cemento (opz. M03)
cement



noce fiammato (opz. M24)
flamed walnut



rovere moro (opz. M26)
dark oak

CODICE / CODE

DESCRIZIONE / DESCRIPTION

08MS14L

Fenix 140 x 90 Allungabile 190 H 75 / Fenix 140 x 90 Extendable 190 H 75

08MS16L

Fenix 160 x 90 Allungabile 210 H 75 / Fenix 160 x 90 Extendable 210 H 75

08MS14M

Melaminico 140 x 90 Allungabile 190 H 75 / Melamine 140 x 90 Extendable 190 H 75

08MS16M

Melaminico 160 x 90 Allungabile 210 H 75 / Melamine 160 x 90 Extendable 210 H 75

MASTER

