

MODELLI / MODELS

- 4 Rebecca
- 8 Anita
- 12 Elena
- 16 Luisa
- 20 Onelia Laccata
- 24 Onelia Noce
- 28 Beatrice

MANIGLIE - STRUTTURE / HANDLES - STRUCTURES

- 32 Maniglie di serie / Standard handles
- 33 Maniglie vintage / Vintage handles
- 34 Maniglie artigianato artistico / Artistic craft handles
- 36 Colori effetto Muro / Wall-effect colours
- 38 Cornici ante vetro / Glass door frames
- 39 Strutture Pensili - basi e cassoni / Wall-unit Structures - base units and carcasses
- 40 Cerniere e zoccoli / Hinges and plinths
- 41 Maggiorazioni fuori misura / Surcharges for custom sizes

PENSILI - SCOLAPIATTI /

WALL UNITS - DISH DRAINER UNITS

- 44 Pensili / Wall units
- 54 Scolapiatti / Dish drainer units
- 61 Pensili folding / Folding wall units
- 62 Piattaie / Plate racks
- 63 Boiserie Dream / Dream Boiserie

CAPPE / HOODS

- 66 Cappe camino / Chimney hoods

BASI / BASE UNITS

- 82 Basi / Base units
- 89 Basi angolo / Corner base units
- 90 Basi forno / Oven base units
- 91 Basi sottolavello / Sink base units
- 94 Basi elettrodomestici / Appliance base units
- 98 Basi forno - muretto / Oven base units - low wall

ELEMENTI SOPRAPIANO / ABOVE-WORKTOP ELEMENTS

- 100 Elementi sopra piano / Above-worktop elements
- 104 Elementi sottopensili / Under-wall unit elements
- 105 Madia - Elementi sopra piano / Sideboard - Above-worktop elements

COLONNE DISPENSA / CUPBOARD COLUMNS

- 106 Colonne dispensa / Cupboard columns
- 114 Colonne terminali / End columns
- 116 Colonne frigo e dispensa / Cupboard and fridge columns

COLONNE FORNO / OVEN COLUMNS

- 118 Colonne forno / Oven columns
- 127 Colonne forno e microonde / Oven and microwave columns
- 128 Colonne forno / Oven columns
- 132 Colonne forno e microonde / Oven and microwave columns

COLONNE FRIGO / FRIDGE COLUMNS

- 134 Colonne frigo / Fridge columns
- 144 Colonne frigo free-standing / Free-standing fridge columns
- 146 Maggiorazioni per colonne / Surcharges for columns
- 149 Tipologie nicchie / Niche types

ELEMENTI EFFETTO MURO - ELEMENTI A GIORNO /
WALL-EFFECT ELEMENTS - OPEN UNITS

- 150 Elementi effetto muro / Wall-effect elements
- 154 Elementi a giorno / Open units
- 158 Accessori / Accessories

PENISOLE - LIVING / PENINSULAS - LIVING ROOM

- 162 Penisole / Peninsulas
- 168 Living - mobili di completamento / Living room - accessory cabinets
- 170 Living / Living room
- 178 Living / Living room

COMPOSIZIONI TIPO / TYPICAL COMPOSITIONS

- 184 Composizioni tipo / Typical compositions
- 194 Condizioni di vendita / Conditions of sale

CARATTERISTICHE TECNICHE**Anta pannello liscio**

Pannello in listellare impiallacciato di rovere spazzolato nei colori: Rovere Naturale (opz. 170) Rovere Bianco Pietra (opz. 171) Rovere Tabacco (opz. 172) Rovere Fango (opz. 173) spessore 24 mm

Anta vetro

Telaio in massello di rovere spazzolato spessore 24 mm con i seguenti vetri:

- **di serie:** Vetro Anticato spessore 4 mm (opz. V15);
- **a richiesta:** Vetro Gotik spessore 4 mm (opz. V20);
- **a richiesta:** Vetro Master Carrè spessore 4 mm (opz. V25).

Struttura pensili

In listellare impiallacciato spessore 25 mm finitura come anta.

Struttura cappe

Fascione in rovere spazzolato, camino in multistrato di pioppo finitura effetto muro (vedi colori effetto muro pag. 36).

Struttura basi e colonne

Frontale e parti a vista in multistrato di pioppo finitura effetto muro (vedi colori effetto muro pag. 36). Cassone in listellare laminato oak, spessore 18 mm (opz. 110) o in listellare laminato twist, spessore 18 mm (opz. 115).

Struttura cassette e cestoni

In massello di faggio naturale con guide estrazione totale sistema blumotion.

Mensole

In listellare impiallacciato di rovere, finitura come anta.

Zoccolo

Impiallacciato finitura come anta h 10 cm

TECHNICAL FEATURES**Door with smooth panel**

Panel in blockboard with brushed oak veneer in the following colours: Natural Oak (opt. 170) Stone White Oak (opt. 171) Tobacco Oak (opt. 172) Mud Oak (opt. 173) thickness: 24 mm

Glass door

Frame in solid brushed oak 24 mm thick, with the following glass:

- **standard:** Antique-effect glass, 4 mm thick (opt. V15);
- **on request:** Gothic glass, 4 mm thick (opt. V20);
- **on request:** Master Carrè glass, 4 mm thick (opt. V25).

Wall unit structure

In veneered blockboard, 25 mm thick same finish as door.

Hood structure

Band in brushed oak, chimney in poplar plywood with wall-effect finish (see wall-effect colours on page 36).

Columns and base unit structures

Front panel and visible parts in poplar plywood with wall-effect finish (see wall-effect colours on page 36).

Carcass in blockboard with oak veneer, thickness: 18 mm (opt. 110) or in blockboard with twist veneer, thickness: 18 mm (opt. 115).

Structures for drawers and deep drawers

In solid natural beech with full extraction runners with blumotion system.

Shelves

In blockboard with oak veneer, same finish as doors.

Plinth

Veneer, same finish as doors h 10 cm

**ANTE
DOORS**



Rovere Naturale (opz. 170)
Natural Oak (opt. 170)



Rovere Bianco Pietra (opz. 171)
Stone White Oak (opt. 171)



Rovere Tabacco (opz. 172)
Tobacco Oak (opt. 172)



Rovere Fango (opz. 173)
Mud Oak (opt. 173)

**ANTE GRATA LEGNO
DOORS WITH GRATING WOOD**



Rovere Naturale (opz. 170)
Natural Oak (opt. 170)

**ANTE GRATA FERRO
DOORS WITH GRATING IRON**



Rovere Naturale (opz. 170)
Natural Oak (opt. 170)

**ANTE VETRO
GLASS DOORS**



Vetro antico (opz. V15)
Antique-effect Glass (opt. V15)



Vetro Gotik (opz. V20)
Gothic Glass (opt. V20)



Vetro Master Carrè (opz. V25)
Master Carrè Glass (opt. V25)



Anta Rebecca
 Rovere Naturale (opz. 170)
 Maniglia Old Style (opz. B018)
 Rebecca Door
 Natural Oak (opt. 170)
 Old Style handle (opt. B018)



Anta Vetro Master Carrè (opz. V25)
 Door with Master Carrè Glass (opt. V25)



Top Serie Sassi
 sp. 6 cm Travertino Chiaro (opz. 127)
 Sassi Series Top
 6 cm thick, Light Travertine (opt. 127)



Lavello in marmo ad incasso
 colore Travertino Paglierino
 (opz. M006)
 Marble inset sink in Straw-coloured
 Travertine (opt. M006)



Cornice cappello
 colore Rovere Naturale (opz. 170) tipo B
 Top Cornice
 Natural Oak colour (opt. 170) type B



Muratura Panna a rullo (opz. R012)
 Zoccolo
 colore Rovere Naturale (opz. 170)
 Roller Cream Masonry (opt. R012)
 Plinth
 Natural Oak Colour (opt. 170)





170 ~ REBECCA

CARATTERISTICHE TECNICHE**Anta con bugna**

Telaio in massello e pannello impiallacciato in castagno, anticato e spazzolato Tinto Noce (opz. 135), Castagno Mielato (opz. 136) Bianco Antico (opz. 137), Verde Antico (opz.138) Castagno Gessato (opz. 139) spessore 32 mm

Anta vetro

Telaio in massello di castagno, anticato e spazzolato con i seguenti vetri:

- **di serie:** Vetro Anticato spessore 4 mm (opz. V15);
- **a richiesta:** Vetro Gotik spessore 4 mm (opz. V20).

Struttura pensili

In listellare impiallacciato sp. 25 mm colore come anta (opz. 090);

Struttura cappe

Fascione in frassino spazzolato, camino in multistrato di pioppo finitura effetto muro (vedi colori effetto muro pag. 36);

Struttura basi e colonne

Frontale e parti a vista in multistrato di pioppo finitura effetto muro (vedi colori effetto muro pag. 36):
Cassone in listellare laminato oak, spessore 18 mm (opz. 110), o in listellare laminato twist, spessore 18 mm (opz. 115).

Struttura cassette e cestoni

In massello di faggio naturale con guide estrazione totale sistema blumotion.

Mensole

In listellare impiallacciato di castagno, finitura come anta.

Zoccolo

Impiallacciato frassino colore come anta h 10 cm

TECHNICAL FEATURES**Door with raised panel**

Solid frame and veneer panel in chestnut, Walnut Stain brushed antique effect (opt. 135), Honey Chestnut (opt. 136) Antique White (opt. 137), Antique Green (opt. 138) Pinstripe Chestnut (opt. 139), thickness: 32 mm

Glass door

Frame in solid chestnut, brushed antique effect, with the following glass:

- **standard:** Antique-effect glass, 4 mm thick (opt. V15);
- **on request:** Gothic glass, 4 mm thick (opt. V20).

Wall unit structure

In veneered blockboard, 25 mm thick, same colour as doors (opt. 090);

Hood structure

Band in brushed ash, chimney in poplar plywood with wall-effect finish (see wall-effect colours on page 36);

Columns and base unit structures

Front panel and visible parts in poplar plywood with wall-effect finish (see wall-effect colours on page 36):

Carcass in blockboard with oak veneer, thickness: 18 mm (opt. 110) or in blockboard with twist veneer, thickness: 18 mm (opt. 115).

Structures for drawers and deep drawers

In solid natural beech with full extraction runners with blumotion system.

Shelves

In blockboard with chestnut veneer, same finish as doors.

Plinth

Ash veneer, same colour as doors h 10 cm

**ANTE
DOORS**



Tinto Noce Antico (opz. 135)
Antique Walnut Stain (opt. 135)



Mielato (opz. 136)
Honey (opt. 136)



Bianco Antico (opz. 137)
Antique White (opt. 137)



Verde Antico (opz. 138)
Antique Green (opt. 138)

**ANTA GRATA LEGNO
DOOR WITH GRATING WOOD**



Gessato (opz. 139)
Pinstripe (opt. 139)



Mielato (opz. 136)
Honey (opt. 136)

**ANTE VETRO
GLASS DOORS**



Vetro Anticato (opz. V15)
Antique-effect Glass (opt. V15)



Vetro Gotik (opz. V20)
Gothic Glass (opt. V20)

130 ~ ANITA



Anta Bianco Antico (opz. 137)
Pomo Terra Cotta (opz. B010)
Antique White Door (opt. 137)
Terracotta Knob (opt. B010)



Anta Vetro Gotik (opz. V20)
Gothic Glass Door (opt. V20)



Top serie Vintage colore Ecrù (opz. 272)
bordo massello sp. 6 cm
Vintage Series Top, Ecrù colour
(opt. 272) solid wood edge, 6 cm thick



Cornice cappello
colore Bianco Antico (opz. 137) tipo A
Top cornice
Antique White colour (opt. 137) type A



Muratura Cuoio a rullo (opz. R260)
Zoccolo
colore Bianco Antico (opz. 137)
Roller Leather masonry (opt. R260)
Plinth Antique White colour (opt. 137)





130 ~ ANITA

MODELLI
MODELS

CARATTERISTICHE TECNICHE**Anta con pannello a rilievo**

Telaio in massello di frassino spazzolato, con anticature, maniglia ricavata nella parte superiore o inferiore del telaio e pannello centrale in rilievo con doghe verticali nei colori: Bianco Shabby (opz. 150), Noce (opz. 151), Elena Sabbia (opz. 156), spessore 24 mm

Anta vetro

Telaio in massello di frassino spazzolato anticato con inglesina, con vetro anticato spessore 4 mm (opz. V15).

Struttura pensili

In listellare impiallacciato frassino sp. 25 mm colore come anta.

Struttura cappe

Fascione in massello di frassino colore abbinato all'anta, camino in multistrato di pioppo finitura effetto muro (vedi colori effetto muro pag. 36).

Struttura basi e colonne

Frontale e parti a vista in multistrato di pioppo finitura effetto muro (vedi colori effetto muro pag. 36).

Cassone in listellare laminato oak, spessore 18 mm (opz. 110), o in listellare laminato twist, spessore 18 mm (opz. 115).

Struttura cassetti e cestoni

In massello di faggio naturale con guide estrazione totale sistema blumotion.

Mensole

In listellare impiallacciato di frassino, finitura come anta.

Zoccolo

In multistrato impiallacciato frassino, colore come anta h 10 cm

TECHNICAL FEATURES**Door with relief panel**

Frame in brushed solid ash, with antique effect, handle placed on the upper or lower part of the frame and central panel in relief with vertical slats in the following colours: Shabby white (opt. 150), Walnut (opt. 151), Elena Sand (opt. 156), thickness: 24 mm

Glass door

Frame in brushed solid ash with antique effect, with mullion accents, with antique-effect glass, thickness: 4 mm (opt. V15).

Wall unit structure

In ash veneered blockboard, 25 mm thick, same colour as doors.

Hood structure

Band in solid ash in the same colour as the doors, chimney in poplar plywood with wall-effect finish (see wall-effect colours on page 36);

Columns and base unit structures

Front panel and visible parts in poplar plywood with wall-effect finish (see wall-effect colours on page 36).

Carcass in blockboard with oak veneer, thickness: 18 mm (opt. 110) or in blockboard with twist veneer, thickness: 18 mm (opt. 115).

Structures for drawers and deep drawers

In solid natural beech with full extraction runners with blumotion system.

Shelves

In blockboard with ash veneer, same finish as doors.

Plinth

In plywood with ash veneer, same colour as doors h 10 cm

**ANTE
DOORS**



Bianco Shabby (opz. 150)
Shabby White (opt. 150)



Noce (opz. 151)
Walnut (opt. 151)



Sabbia (opz. 156)
Sand (opt. 156)

**ANTA VETRO
GLASS DOORS**



Vetro anticato (opz. V15)
Antique-effect Glass (opt. V15)

140 ~ ELENA



Anta Elena Sabbia (opz. 156)
con presa maniglia su anta
Elena Door in Sand (opt. 156) with
handle grip on door



Anta vetro: Inglesina (opz. V15)
Glass Door: Mullion accents (opt. V15)



Top Serie Sassi sp. 6 cm profilo G,
colore Travertino Chiaro con inserti
Travertino Noce (opz. 003)
Sassi Series Top, 6 cm thick, profile
G, Light Travertine colour with in-
serts in Walnut Travertine (opt. 003)



Lavello ad incasso, in marmo
colore Travertino Noce (opz. M004)
Recessed sink, in Walnut Travertine
coloured marble (opt. M004)



Cornice cappello tipo A
colore Elena Sabbia (opz. 156)
Top cornice type A
colour Elena Sand (opt. 156)



Muratura Panna a rullo (opz. R012)
Zoccolo
colore Elena Sabbia (opz. 156)
Roller Cream masonry (opt. R012)
Plinth
Elena Sand colour (opt. 156)





140 ~ ELENA

CARATTERISTICHE TECNICHE**Anta con pannello fresato**

Telaio in massello di frassino con tagli a 45° e pannello a doghe orizzontali, nei colori: Noce Antico (opz. 161), Bianco Rustico (opz. 162), Gessato (opz. 163), Creta (opz. 164), anta spazzolata, tinta e patinata con effetto anticatura spessore 24 mm.

Anta vetro

Telaio in massello di frassino spazzolato e anticato con i seguenti vetri:

- **di serie:** Vetro Anticato spessore 4 mm (opz. V15);
- **a richiesta:** Vetro Gotik spessore 4 mm (opz. V20).

Struttura pensili

In listellare impiallacciato di frassino sp. 25 mm colore come anta.

Struttura cappe

Fascione in massello di frassino colore abbinato all'anta, camino in multistrato di pioppo finitura effetto muro (vedi colori effetto muro pag. 36).

Struttura basi e colonne

Frontale e parti a vista in multistrato di pioppo finitura effetto muro (vedi colori effetto muro pag. 36).

Cassone in listellare laminato oak, spessore 18 mm (opz. 110); o in listellare laminato twist, spessore 18 mm (opz. 115).

Struttura cassette e cestoni

In massello di faggio naturale con guide estrazione totale sistema blumotion.

Mensole

In listellare impiallacciato di frassino, finitura come anta.

Zoccolo

In multistrato impiallacciato frassino, colore come anta h 10 cm

TECHNICAL FEATURES**Door with milled panel**

Frame in solid ash with 45° cuts and panel with horizontal slats, in the following colours: Antique Walnut (opt. 161), Rustic White (opt. 162), Pinstripe (opt. 163), Clay (opt. 164), brushed, stained and patinated door with antique effect, thickness: 24 mm.

Glass door

Frame in solid ash, brushed antique effect, with the following glass:

- **standard:** Antique-effect glass, 4 mm thick (opt. V15);
- **on request:** Gothic glass, 4 mm thick (opt. V20).

Wall unit structure

In ash veneered blockboard, 25 mm thick, same colour as doors.

Hood structure

Band in solid ash in the same colour as the doors, chimney in poplar plywood with wall-effect finish (see wall-effect colours on page 36);

Columns and base unit structures

Front panel and visible parts in poplar plywood with wall-effect finish (see wall-effect colours on page 36).

Carcass in blockboard with oak veneer, thickness: 18 mm (opt. 110) or in blockboard with twist veneer, thickness: 18 mm (opt. 115).

Structures for drawers and deep drawers

In solid natural beech with full extraction runners with blumotion system.

Shelves

In blockboard with ash veneer, same finish as doors.

Plinth

In plywood with ash veneer, same colour as doors h 10 cm

**ANTE
DOORS**



Noce Antico (opz. 161)
Antique Walnut (opt. 161)



Bianco Rustico (opz. 162)
Rustic White (opt. 162)



Gessato (opz. 163)
Pinstripe (opt. 163)



Creta (opz. 164)
Clay (opt. 164)

**ANTA GRATA LEGNO
DOOR WITH GRATING WOOD**



Noce Antico (opz. 161)
Antique Walnut (opt. 161)

**ANTE VETRO
GLASS DOORS**



Vetro Anticato (opz. V15)
Antique-effect Glass (opt. V15)



Vetro Gotik (opz. V20)
Gothic Glass (opt. V20)

160 ~ LUISA



Anta Luisa Gessata (opz. 163)
Maniglia ceramica
con pomo rosa (opz. B009)
Pinstripe Luisa Door (opt. 163)
Ceramic handle with pink knob
(opt. B009)



Anta Vetro Anticato (opz. V15)
Door with Antique-effect Glass
(opt. V15)



Top Serie Sassi sp. 5 cm
con torello colore Scabas Rosa (opz.110)
Sassi series top, 5 cm thick, with
Scabas Pink bullnose tile (opt.110)



Lavello in marmo ad incasso
colore Travertino Paglierino
(opz. M006)
Marble inset sink in Straw-coloured
Travertine (opt. M006)



Top in massello spessore 6 cm. profilo
L2 con Greca incassata,
spessore h. 3 cm (serie infinito)
Top in solid wood, 6 cm thick,
profile L2 with recessed fretwork
h. 3 cm (infinito series)



Cornice cappello tipo A
Luisa Gessata (opz. 163)
Top cornice type A
Pinstripe Luisa (opt. 163)



Muratura Bianco frattonato (F006)
Zoccolo colore
Luisa Gessata (opz. 163)
Trowel White masonry (F006)
Plinth colour
Pinstripe Luisa (opt. 163)





160 ~ LUISA

CARATTERISTICHE TECNICHE

Anta con bugna

Telaio e bugna in massello di frassino laccati colore Avorio con Sfumature Arancio (opz. 002), con Sfumature Giallo (opz. 003), laccato Bianco con Sfumature Grigie (opz. 007). L'effetto anticato è dato da un particolare processo di laccatura che lascia scoperte alcune parti dell'anta.

L'anta ha uno spessore di 24 mm;

Anta vetro

Telaio in frassino laccato con anticatura, spessore 24 mm, abbinabile ai seguenti vetri:

- **di serie:** Vetro Anticato spessore 4 mm (opz. V15)
- **a richiesta:** Vetro Gotik spessore 4 mm (opz. V20)

Struttura pensili

In listellare impiallacciato di frassino spessore 25 mm, colore come anta

Struttura cappe

Fascione in massello di frassino abbinato all'anta, camino in multistrato di pioppo finitura effetto muro (vedi muratura pag. 36).

Struttura basi e colonne

Frontale e parti a vista in multistrato di pioppo finitura effetto muro

(vedi colori effetto muro pag. 36)

Cassone in listellare laminato oak, spessore 18 mm (opz. 110), o listellare laminato twist, spessore 18 mm (opz. 115).

Struttura cassette e cestoni

In massello di faggio naturale con guide estrazione totale sistema blumotion.

Mensole

In listellare impiallacciato di frassino, finitura come anta.

Zoccolo

In multistrato impiallacciato, finitura come anta h 10 cm

TECHNICAL FEATURES

Door with raised panel

Frame and raised panel in solid ash in lacquered ash in Ivory with Orange highlights (opt. 002), with Yellow Highlights (opt. 003), White lacquer with Grey Highlights (opt. 007). The antique effect is created using a special lacquering process that leaves parts of the door uncoated.

The door is 24 mm thick;

Glass door

Frame in lacquered ash with antique effect, 24 mm thick, can be matched with the following glass:

- **standard:** Antique-effect glass, 4 mm thick (opt. V15)
- **on request:** Gothic glass, 4 mm thick (opt. V20)

Wall unit structure

In ash veneered blockboard, 25 mm thick, same colour as doors

Hood structure

Band in solid ash in the same colour as the doors, chimney in poplar plywood with wall-effect finish (see masonry on page 36);

Columns and base unit structures

Front panel and visible parts in poplar plywood with wall-effect finish (see wall-effect colours on page 36)

Carcass in blockboard with oak veneer, thickness: 18 mm (opt. 110) or in blockboard with twist veneer, thickness: 18 mm (opt. 115)

Structures for drawers and deep drawers

In solid natural beech with full extraction runners with blumotion system.

Shelves

In blockboard with ash veneer, same finish as doors.

Plinth

In plywood with veneer, same finish as doors h 10 cm

**ANTE
DOORS**



Laccato Avorio Sfum. Arancio (opz. 002)
Ivory Lacquer Orange Highlights (opt. 002)



Laccato Avorio Sfum. Giallo (opz. 003)
Ivory Lacquer Yellow Highlights (opt. 003)

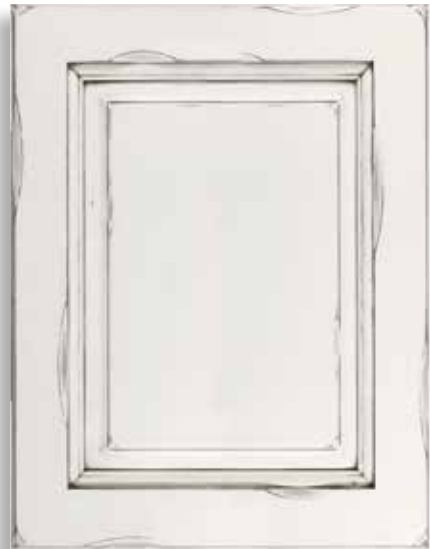

Laccato Bianco Sfum. Grigie (opz. 007)
White Lacquer Grey Highlights (opt. 007)

**ANTA GRATA LEGNO
DOOR WITH GRATING WOOD**



Laccato Avorio Sfum. Giallo (opz. 003)
Ivory Lacquer Yellow Highlights (opt. 003)

**ANTE VETRO
GLASS DOORS**



Vetro Anticato (opz. V15)
Antique-effect Glass (opt. V15)



Vetro Gotik (opz. V20)
Gothic Glass (opt. V20)



Anta Onelia Laccata Avorio
Sfumatura Arancio (opz. 002)

Onelia Door in Ivory Lacquer with
Orange Highlights (opt. 002)



Anta Vetro Anticato (opz. V15)
Door with Antique-effect Glass
(opt. V15)



Top Serie Cotto colore Avorio
sp. 4 cm (opz. 260)
Cotto Series Top in Ivory, 4 cm thick
(opt. 260)



Cornice cappello Laccato Avorio
Sfumatura Arancio (opz. 002)
Top cornice in Ivory Lacquer with
Orange Highlights (opt. 002)



Muratura Corda frattonato (opz. F125)
Zoccolo colore Laccato Avorio
Sfumatura Arancio (opz. 002)
Trowel Jute masonry (opt. F125)
Plinth in Ivory Lacquer with Orange
Highlights (opt. 002)





111 ~ ONELIA LACCATA

CARATTERISTICHE TECNICHE**Anta con bugna**

Telaio e bugna in massello di frassino tinto Noce
Anticato a straccio (opz. 110)
Spessore 24 mm

Anta vetro

Telaio in frassino tinto Noce Anticato a straccio
(opz. 110)
Spessore 24 mm con i seguenti vetri:
• **di serie:** Vetro Anticato spessore 4 mm (opz. V15);
• **a richiesta:** Vetro Gotik spessore 4 mm (opz. V20).

Struttura pensili

In listellare impiallacciato di frassino,
spessore 25 mm colore come ante.

Struttura cappe

Fascione in massello di frassino tinto noce,
camino in multistrato di pioppo finitura
effetto muro (vedi colori effetto muro pag. 36)

Struttura basi e colonne

Frontale e parti a vista in multistrato di pioppo
finitura effetto muro (vedi colori effetto muro pag. 36)
Cassone in listellare laminato oak
spessore 18 mm (opz. 110)

Struttura cassette e cestoni

In massello di faggio naturale con guide estrazione
totale sistema blumotion.

Mensole

In listellare impiallacciato di frassino,
finitura come anta

Zoccolo

In multistrato impiallacciato,
finitura come anta h 10 cm

TECHNICAL FEATURES**Door with raised panel**

Frame and raised panel in solid ash in worn
Antique Walnut stain (opt. 110)
Thickness 24 mm

Glass door

Frame in ash in worn Antique Walnut stain (opt. 110)
24 mm thick, with the following glass:
• **standard:** Antique-effect glass, 4 mm thick (opt. V15);
• **on request:** Gothic glass, 4 mm thick (opt. V20).

Wall unit structure

In blockboard with ash veneer, 25 mm thick,
same finish as doors.

Hood structure

Band in solid ash in ash with walnut stain,
chimney in poplar plywood with wall-effect finish
(see wall-effect colours on page 36);

Columns and base unit structures

Front panel and visible parts in poplar plywood
with wall-effect finish (see wall-effect colours
on page 36)
Carcass in blockboard with oak veneer,
18 mm thick (opt. 110)

Structures for drawers and deep drawers

In solid natural beech with full extraction runners
with blumotion system.

Shelves

In blockboard with ash veneer,
same finish as doors

Plinth

In plywood with veneer,
same finish as doors h 10 cm

**ANTE
DOORS**



Frassino Tinto Noce (opz. 110)
Walnut Stained Ash (opt. 110)

**ANTA GRATA LEGNO
DOOR WITH GRATING WOOD**



Frassino Tinto Noce (opz. 110)
Walnut Stained Ash (opt. 110)

**ANTE VETRO
GLASS DOORS**



Vetro Anticato (opz. V15)
Antique-effect Glass (opt. V15)



Vetro Gotik (opz. V20)
Gothic Glass (opt. V20)

110 ~ ONELIA NOCE



Anta Onelia Noce (opz. 110)

Onelia Door in Walnut (opt. 110)



Anta Vetro: Anticato (opz V15)

Glass door: Antique finish (opt. V15)



Top Serie Sassi

sp. 4 cm colore Travertino Chiaro (opz. 127)

Sassi Series Top

4 cm thick, in Light Travertine (opt. 127)



Cornice cappello tipo A

colore Onelia Noce (opz. 110)

Top cornice type A

Onelia Walnut colour (opt. 110)



Muratura Panna frattonato (opz. F012)

Zoccolo

colore Onelia Noce (opz. 110)

Trowel Cream masonry (opt. F012)

Plinth

Onelia Walnut colour (opt. 110)





110 ~ ONELIA NOCE

CARATTERISTICHE TECNICHE**Anta con bugna**

Telaio e bugna in pioppo, nelle finiture colori: Laccato Bianco Antico Sfumature Oro (opz. 140), Laccato Giallo Grano (opz. 147), Laccato Verde Salvia (opz. 146), Laccato Argilla con Sfumature Avorio (opz. 148) Tinto Noce Antico (opz. 145). L'effetto anticato è dato da un particolare processo di laccatura che lascia scoperte alcune parti dell'anta.

Anta vetro

Telaio in massello di pioppo, spessore 24 mm. Abbinabile ai seguenti vetri:

- **di serie:** Vetro Anticato spessore 4 mm (opz. V15);
- **a richiesta:** Vetro Gotik spessore 4 mm (opz. V20).

Struttura pensili

In listellare impiallacciato diiglio sp. 25 mm colore come anta.

Struttura cappe

Fascione in massello diiglio colore come anta, camino in multistrato di pioppo finitura effetto muro (vedi colori effetto muro pag. 36);

Struttura basi e colonne

Frontale e parti a vista in multistrato di pioppo finitura effetto muro (vedi colori effetto muro pag. 36). Cassone in listellare laminato oak, spessore 18 mm (opz. 110), o in listellare laminato twist, spessore 18 mm (opz. 115);

Struttura cassette e cestoni

Interno in massello di faggio naturale con guide estrazione totale sistema blumotion.

Mensole

In listellare impiallacciato diiglio, finitura come anta.

Zoccolo

In multistrato impiallacciato diiglio, finitura come anta h 10 cm.

TECHNICAL FEATURES**Door with raised panel**

Frame and raised panel in poplar, in the following colours: Antique White Lacquer with Gold Highlights (opt. 140), Corn Yellow Lacquer (opt. 147), Sage Green Lacquer (opt. 146), Clay Lacquer with Ivory Highlights (opt. 148) Antique Walnut Stain (opt. 145). The antique effect is created using a special lacquering process that leaves parts of the door uncoated.

Glass door

Frame in solid poplar, 24 mm thick. Can be matched with the following glass:

- **standard:** Antique-effect glass, 4 mm thick (opt. V15);
- **on request:** Gothic glass, 4 mm thick (opt. V20).

Wall unit structure

In lime veneered blockboard, 25 mm thick, same colour as doors.

Hood structure

Band in solid lime in the same colour as the doors, chimney in poplar plywood with wall-effect finish (see wall-effect colours on page 36);

Columns and base unit structures

Front panel and visible parts in poplar plywood with wall-effect finish (see wall-effect colours on page 36). Carcass in blockboard with oak veneer, thickness: 18 mm (opt. 110) or in blockboard with twist veneer, thickness: 18 mm (opt. 115);

Structures for drawers and deep drawers

Interior in solid natural beech with full extraction runners with blumotion system.

Shelves

In blockboard with lime veneer, same finish as doors.

Plinth

In plywood with lime veneer, same finish as doors h 10 cm.

**ANTE
DOORS**



Laccato Bianco Sfumatura Oro (opz.140)
White Lacquer Gold Highlights (opt.140)



Verde Salvia (opz.146)
Sage Green (opt. 146)



Giallo Grano (opz.147)
Corn Yellow (opt.147)



Argilla Sfumatura Avorio (opz.148)
Clay Ivory Highlights (opt.148)

**ANTA GRATA LEGNO
DOOR WITH GRATING WOOD**



Noce Antico (opz 145)
Antique Walnut (opt. 145)



Noce Antico (opz 145)
Antique Walnut (opt. 145)

**ANTE VETRO
GLASS DOORS**



Vetro Antico (opz. V45)
Antique Glass (opt. V45)



Vetro Gotik (opz. V20)
Gothic Glass (opt. V20)



Anta Legno e Pomello Terracotta
Bianca con decoro bassorilievo
(opz. B008)
Wooden Door and white Terracotta
Knob with bas-relief decoration
(opt. B008)



Anta Vetro Gotik (opz. V20)
Gothic Glass Door (opt. V20)



Top Serie Pietra colore Pietra di Nes
(opz. 034), spessore 6 cm.
Pietra Series Top in Nes Stone
colour (opt. 034), 6 cm thick.



Lavello Botticino (opz. M001)
Botticino Sink (opt. M001)



Top in massello sp. 6 cm, profilo L2
con incasso spessore Greca 3 cm.
(Serie Rosa)
Top in solid wood, 6 cm thick, L2
profile with recessed fretwork, 3 cm
thick. (Rosa Series)



Cornice tipo A
Frame type A



Muratura Panna (opz. R012)
Zoccolo Beatrice Noce (opz. 145)
Cream masonry (opt. R012)
Beatrice plinth in Walnut (opt. 145)





135 ~ BEATRICE



Maniglia 115
finitura ottone anticato passo mm 96
Handle 115
antique brass finish, 96 mm span



Maniglia 605
finitura argento anticato passo mm 96
Handle 605
antique silver finish, 96 mm span



Maniglia B022
finitura nichel satinato passo mm 160
Handle B022
satin nickel finish, 160 mm span



Maniglia 193
finitura ottone anticato
Handle 193
antique brass finish



Maniglia B020
finitura argento anticato passo mm 160
Handle B020
antique silver finish, 160 mm span



Pomello 232P
finitura nichel satinato
Knob 232P
satin nickel finish



Maniglia 230 - metallo finitura nichel satinato
anta L 15 → pomo
anta da L 30 a L 90 → passo 160 mm
Handle 230 - satin nickel finish metal
door W 15 → knob
door from W 30 to W 90 → span 160 mm



Maniglia 220 - metallo finitura nero opaco
anta L 15 → pomo
anta da L 30 a L 90 → passo 128 mm
Handle 220 - metal in matt black finish
door W 15 → knob
door from W 30 to W 90 → span 128 mm



Maniglia 228 - metallo finitura nero opaco
anta da L 15 a L 40 → passo 128 mm
anta da L 45 a L 90 → passo 160 mm
Handle 228 - metal in matt black finish
door from W 15 to L40 → span 128 mm
door from W 45 to W 90 → span 160 mm



Maniglia 240 - metallo satinato vintage
anta da L 15 a L 30 → passo 64 mm
anta da L 40 a L 90 → passo 160 mm
Handle 240 - vintage satin finish metal
door from W 15 to L 30 → span 64 mm
door from W 40 to W 90 → span 160 mm



Maniglia 575 - finitura piombo vintage
anta da L 15 a L 40 → passo 64 mm
anta da L 45 a L 90 → passo 192 mm
Handle 575 - vintage lead finish
door from W 15 to W 40 → span 64 mm
door from W 45 to W 90 → span 192 mm



Maniglia 248 - finitura bronzo scuro
passo 160 mm
Handle 248 - dark bronze finish
span 160 mm



Maniglia 581 ad incasso - finitura bronzo-titanio
anta da L 15 a L 30 → passo 67 mm
anta da L 30 a L 90 → passo 126 mm
Recessed handle 581 - bronze-titanium finish
door from W 15 to W 30 → span 67 mm
door from W 30 to W 90 → span 126 mm



Pomo B008
Pomo in terra cotta bianca con decoro in bassorilievo
Knob B008
White terracotta knob with bas-relief decoration



Pomo B009
Pomo in ceramica bianco opaco
Knob B009
Matt white ceramic knob



Pomo B016
Pomo in terra cotta con decoro
Knob B016
Terracotta knob with decoration



Maniglia B005
Maniglia in ferro verde ramato con decoro ceramica fatto a mano passo mm 96
Handle B005
Handle in green copper-coated iron with hand-made ceramic decoration, 96 mm span



Pomo B002
Pomo in terra cotta nera con decoro
Knob B002
Black terracotta knob with decoration



Pomo B010
Pomo in terra cotta con decoro in bassorilievo
Knob B010
Terracotta knob with bas-relief decoration



Pomo B014
Pomo in terra cotta con decoro
Knob B014
Terracotta knob with decoration



Maniglia B006
Maniglia in ferro con decoro ceramica fatto a mano passo mm 96
Handle B006
Handle in iron with hand-made ceramic decoration, 96 mm span



Pomo B030 - finitura argento anticato con intarsio in ceramica
Misura 5 x 4,5 cm - passo mm 32
Knob B030 - antique silver finish with ceramic inlay
Measurements 5 x 4.5 cm - span 32 mm



Maniglia B040
Maniglia in argento anticato con decoro
passo mm 160
Handle B040
antique silver with decoration, 160 mm span



Pomo 611B
Pomo in ottone con formella bianca
Knob 611B
Knob in brass with white tile



Maniglia old style
in ferro battuto anticato
B017 passo mm 96 -
B018 passo mm 160 -
Old style handle
in antique wrought iron
B017 96 mm span -
B018 160 mm span -

Tutte le Maniglie e i Pomi "Artigianato Artistico" sono pezzi unici con lavorazioni e decori manuali. Gli articoli "Maniglie e Pomi" possono variare tra loro per la tipologia di lavorazione.

All "Artistic craft" handles are unique, with hand-crafted processing and decorations. "Handles and knobs" items may vary from one piece to another due to their processing.





BIANCO
WHITE
rullo (R006) frattonato (F006)
roller (R006) trowel (F006)



GIALLO CHIARO
LIGHT YELLOW
rullo (R023) frattonato (F023)
roller (R023) trowel (F023)



PANNA
CREAM
rullo (R012) frattonato (F012)
roller (R012) trowel (F012)



CIPRIA
PALE PINK
rullo (R114) frattonato (F114)
roller (R114) trowel (F114)



GRIGIO TRAFFICO
TRAFFIC GREY
rullo (R260) frattonato (F260)
roller (R260) trowel (F260)



PALE ASH
PALE ASH
rullo (R114) frattonato (F012)
roller (R114) trowel (F012)



CORDA
JUTE
rullo (R125) frattonato (F125)
roller (R125) trowel (F125)



GRIGIO PERLA
PEARL GREY
rullo (R255) frattonato (F255)
roller (R255) trowel (F255)



CUOIO
LEATHER
rullo (R250) frattonato (F250)
roller (R250) trowel (F250)

VERNICE RULLO
ROLLER PAINT

Cod. QVER1

VERNICE FRATTONATA
TROWEL PAINT

Cod. QVER2

CAMPIONI EFFETTO MURO
WALL-EFFECT SAMPLES

Cod QXCAMP

FINITURE

I frontali e le parti a vista effetto muro sono verniciate con materiali a base di quarzo ed altri elementi naturali.

Le superfici così ottenute sono antimacchia e antigraffio, lavabili con acqua e sapone neutro.

Evitare l'uso di solventi e/o alcool.

Macchie quali caffè e vino rosso possono creare, ove lasciate sedimentare, aloni non rimovibili.

N.B.: ogni composizione verrà corredata di kit manutenzione composto da barattolo di finitura effetto muro (gr. 400) e stucco bianco.

FINISHES

The front panels and visible parts with masonry effect are painted with quartz-based materials and other natural elements. The surfaces thus created are stain and scratch-resistant, they can be washed with water and neutral soap.

Avoid the use of solvents and/or alcohol. Stains such as coffee and red wine if left un-cleaned may create non-removable haloes.

N.B.: each composition will be provided with a maintenance kit comprised of a tub of wall-effect finish (400g) and white putty.



Colori effetto muro/ Wall-effect colours

MANIGLIE / STRUCTURE
HANDLES / STRUCTURES

Beatrice Salvia



Vetro Antico 75 (opz. V15)
Antique Glass 75 (opt. V15)

n.b.: di serie in tutti i modelli
n.b.: standard on all models



Vetro Gotik (opz. V20)
Gothic Glass (opt. V20)

n.b.: a richiesta per tutti i modelli,
escluso modello ELENA
n.b.: on request for all models, except
ELENA model



Vetro Master Carrè (opz. V25)
Master Carrè Glass (opt. V25)

n.b.: esclusivo per modello REBECCA
n.b.: exclusive to REBECCA model



Cornice tipo A
Frame type A

Cod. (QCOR1)

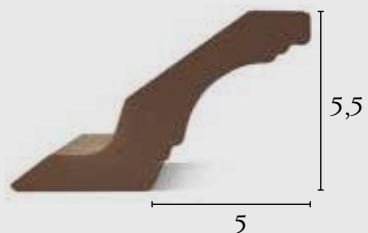

DI SERIE IN TUTTI I MODELLI
STANDARD ON ALL MODELS



Cornice tipo B
Frame type B

Cod. (QCOR2)

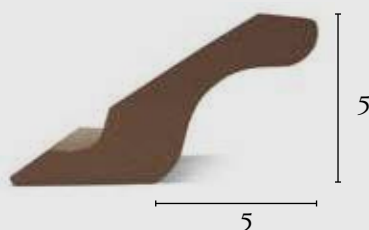

A RICHIESTA
ON REQUEST



Cornice tipo C
Frame type C

Cod. (QCOR3)

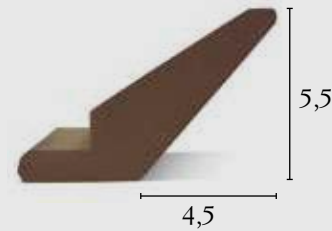

A RICHIESTA
ON REQUEST

**SEZIONE PENSILE
WALL UNIT CROSS SECTION**



**SEZIONE BASE
BASE UNIT CROSS SECTION**

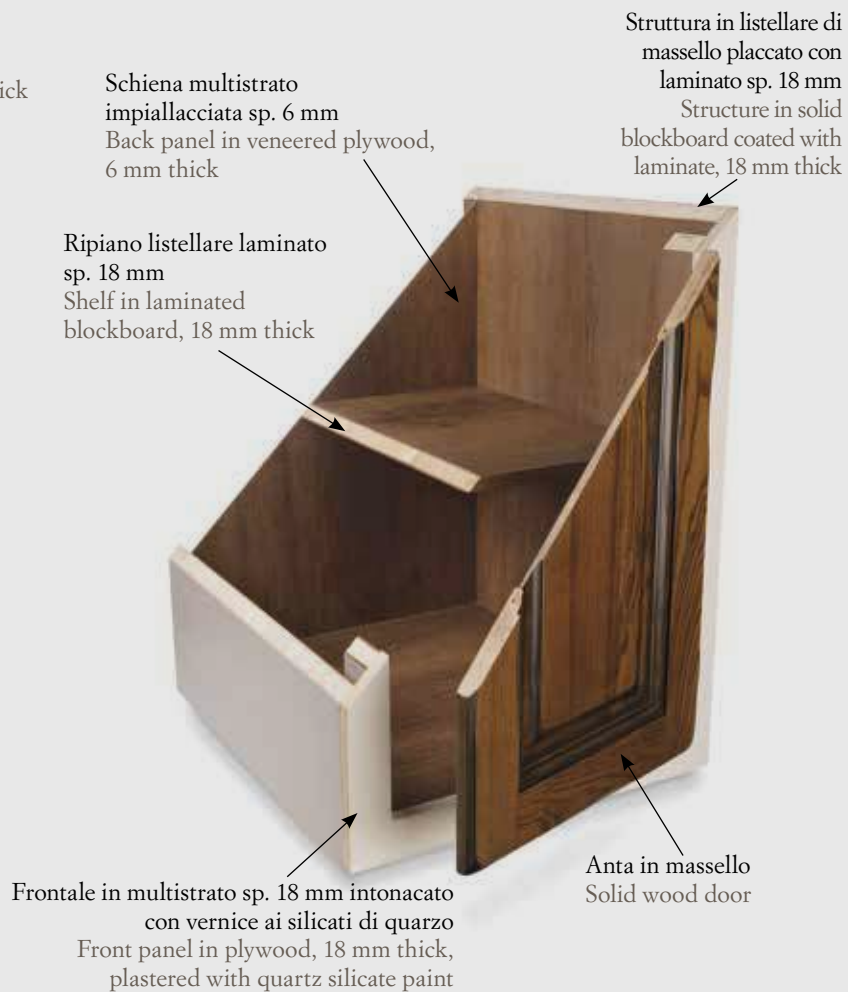

BASI E CASSONI / BASE UNITS AND CARCASSES



Colore Oak (opz. 110)
Oak (opt. 110)



Colore Twist (opz. 115)
Twist (opt. 115)

CERNIERE / HINGES



Cerniera brunita con finta anuba
N.B.: solo per modello Anita
Burnished hinge with false anuba
N.B.: only for Anita model



Anuba Ottone Anticato
Anuba Antique brass



Cerniera ammortizzata Blum
N.B.: a richiesta esclusivo per modello Rebecca
Amortised Blum hinge
N.B.: on request, exclusive to Rebecca model



Anuba Argento Antico
Anuba Antique Silver

Cerniera Anuba di serie per tutti i modelli escluso Anita, in abbinamento al colore della maniglia
Anuba hinge as standard for all models except Anita, matching handle colour

ZOCCOLO / PLINTH

Cod. QZ1
Zoccolo impiallacciato H 10 P 1,2 al ml
Veneered plinth H 10 D 1.2 per lm



Cod. QZ10
Giunzione lineare
Linear joint



Cod. QZ90
Giunzione 90°
90° joint



Cod. QZ36
Giunzione multiangolo
Multi-angle joint
0-360° ∪



TIPOLOGIE DI NICCHIE QUADRATE E ROTONDE
 SQUARE AND ROUND NICHE TYPES

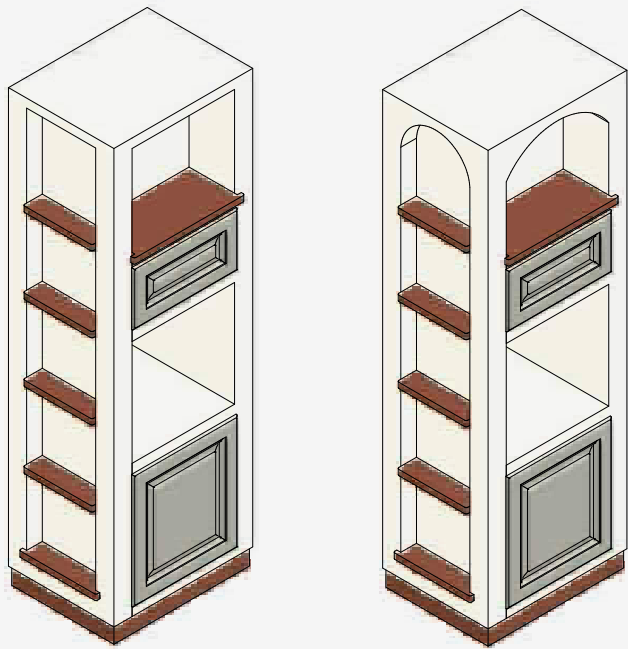

Colonna forno nicchia quadrata/rotonda
 Oven column square/round niche

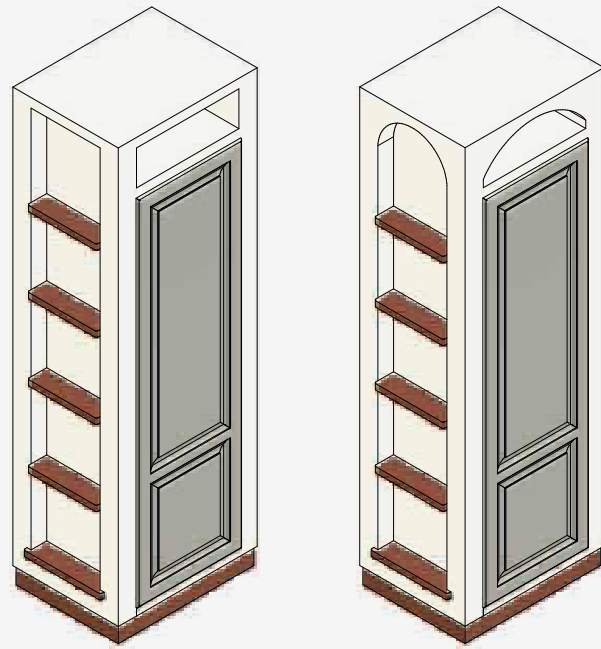

Colonna dispensa/frigo nicchia quadrata/rotonda
 Cupboard/fridge column square/round niche

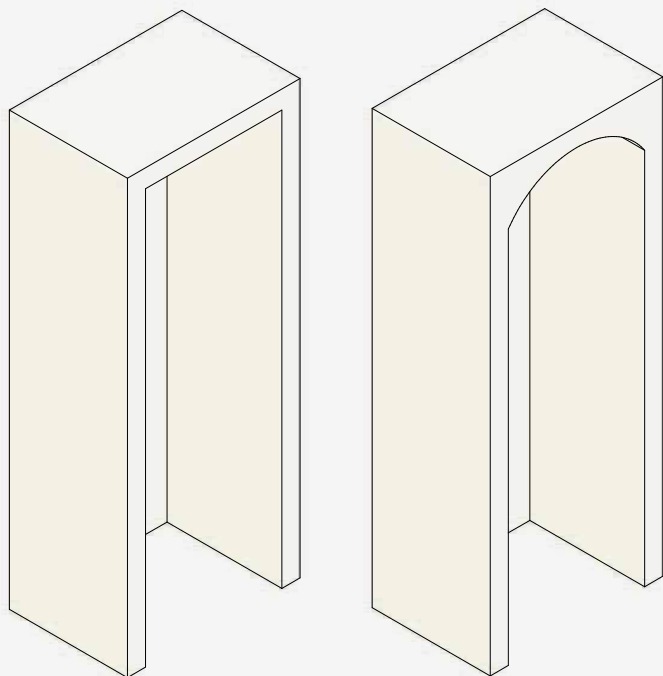

Colonna free standing nicchia quadrata/rotonda
 Free-standing column square/round niche

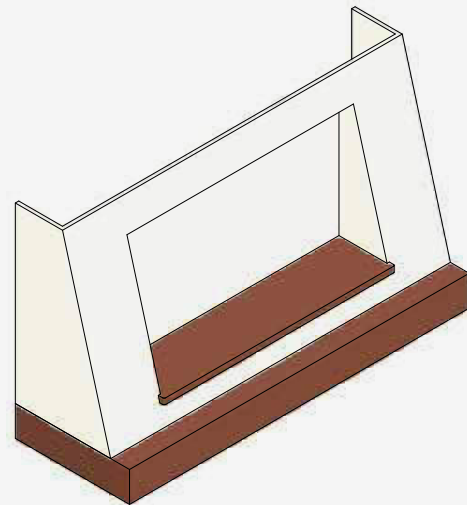

Cappa camino nicchia quadrata
 Chimney hood square niche

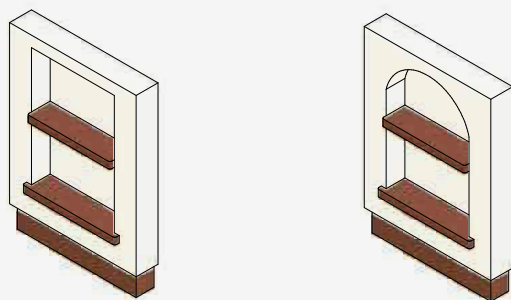

Fianco terminale con nicchia quadrata/rotonda
 End side panel with square/round niche

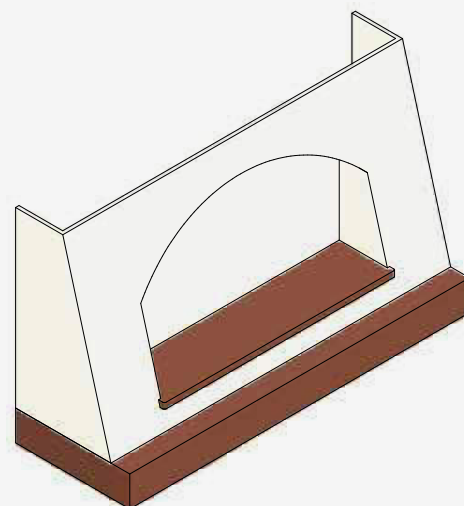

Cappa camino nicchia rotonda
 Chimney hood round niche



Onelia Bianca Sfumature Grigie

MODULO DI SERIE BLOCCO LIVING / LIVING ROOM BLOCK STANDARD MODULE

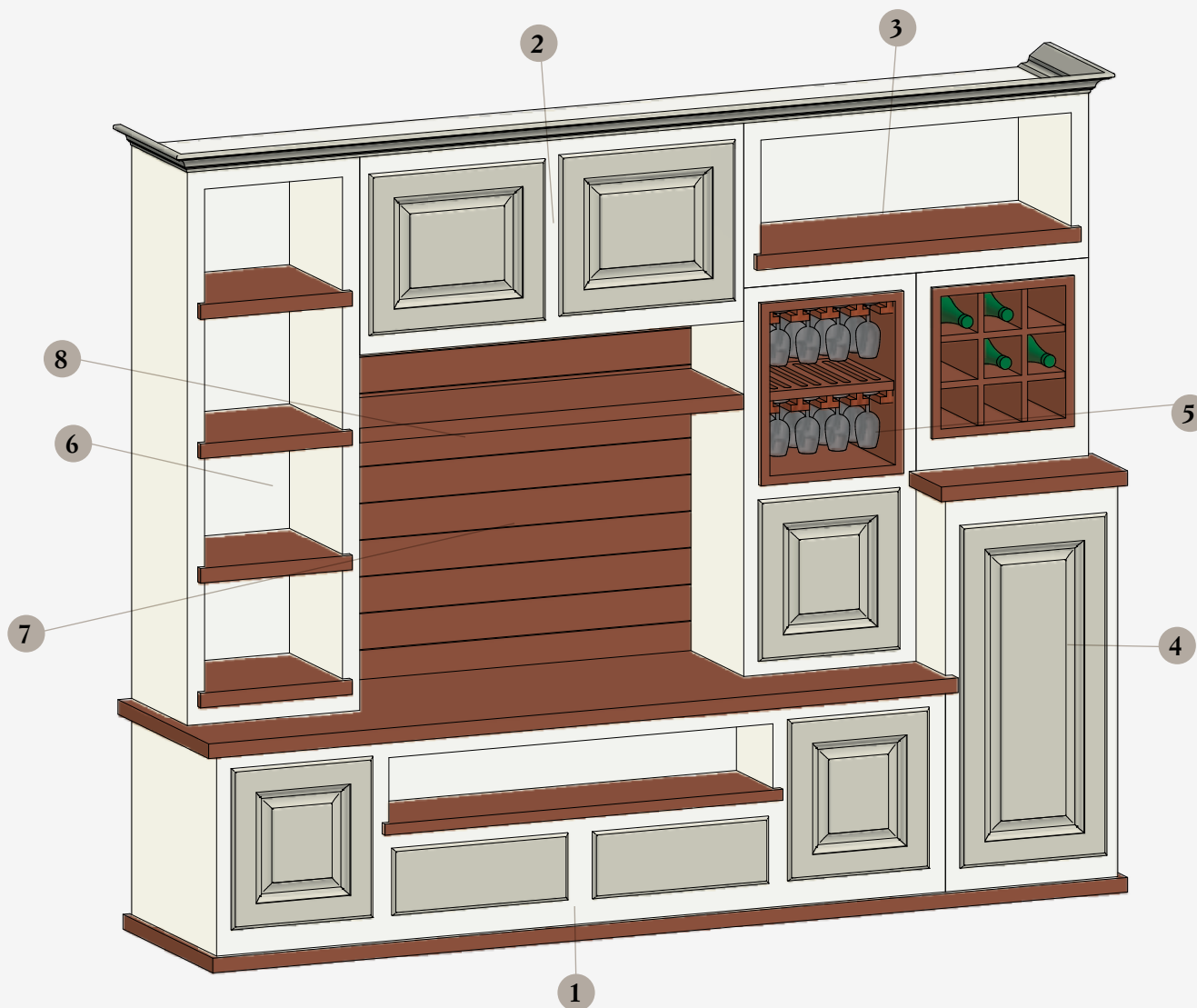

Legenda / Key

- | | | |
|--|--|---|
| 1. Basamento con 2 cassetti e 2 cestoni
Base 2 drawers and 2 deep drawers | 4. Elemento colonna "D1" e portabottiglie 1 anta
Column element "D1" and bottle rack 1 door | 7. Schienale impiallacciato a doghe
Back panel veneered with slats |
| 2. Elemento pensile effetto muro 2 ante
Wall unit element wall effect 2 doors | 5. Elemento colonna "E1" 1 anta con portabicchieri
Column element "E1" 1 door with glass rack | 8. Mensola impiallacciata
Veneered shelf |
| 3. Elemento "C1" nicchia con mensola
Element "C1" niche with shelf | 6. Elemento colonna "F1" nicchia con 4 mensole
Column element "F1" niche with 4 shelves | |

DESCRIZIONE DESCRIPTION

CODICE CODE

Blocco living L 261,5 H 214 P 58
con alloggio Tv, bicchieri, portabottiglie, cestoni estraibili,
nicchie con mensole predisposte per faretto, parti in legno
colori abbinato anta e struttura verniciata effetto muro
Living room block W 261.5 H 214 D 58 with compartments
for TV, glasses, bottle racks, removable deep drawers, niches
with shelves configured for spotlights, parts in wood
with doors and structure painted in wall-effect

L 261,5 QL001 DX
L 261,5 QL002 SX





Living / Living room

Rebecca Rovere Fango

PENSOLE / LIVING
PENINSULAS /
LIVING ROOM

MODULO LIVING DI SERIE / STANDARD LIVING ROOM MODULE



Legenda / Key

- | | | |
|---|--|---|
| 1. Base living, 1 cestone
Living room base unit, 1 deep drawer | 5. Mensola impiallacciata
Veneered shelf | 9. Spalla impiallacciata sp. 2,5 H24/96/228
Veneered upright th 2.5 H24/96/228 |
| 2. Basamento living
Living room base | 6. Top impiallacciato
Veneered top | 10. Schienale impiallacciato sp. 2,8 doghe verticali
Back panel veneered th. 2.8 with vertical slats |
| 3. Anta ribalta per living
Drop-front door for living room | 7. Elemento spalla impiallacciato sp. 2,5 H 96
Veneered upright element th 2.5 H 96 | |
| 4. Pensile folding
Folding wall unit | 8. Elemento spalla impiallacciato sp. 2,5 H 24
Veneered upright element th 2.5 H 24 | |

130 ~ ANITA Gessata





130 ~ ANITA Gessata

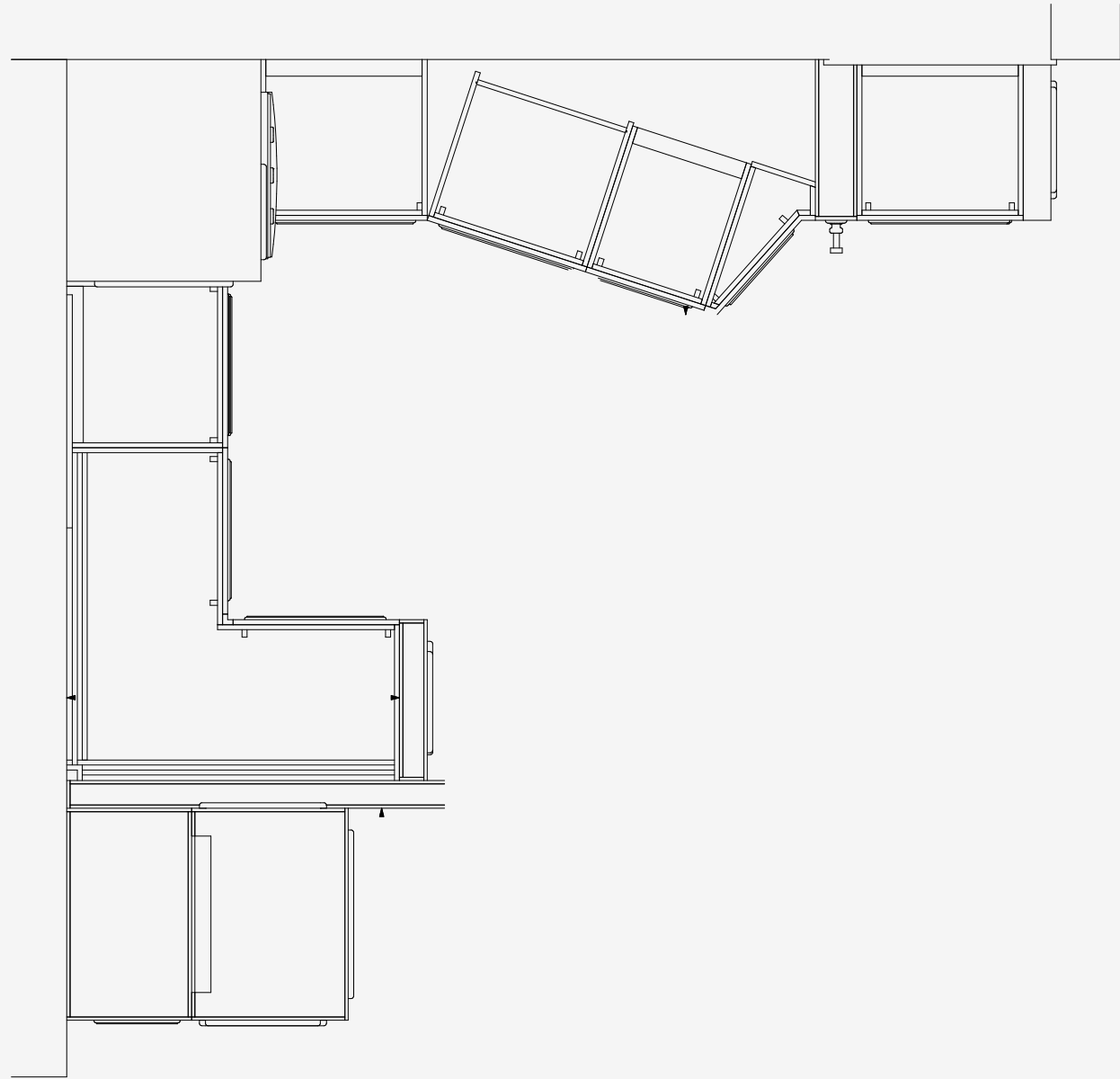

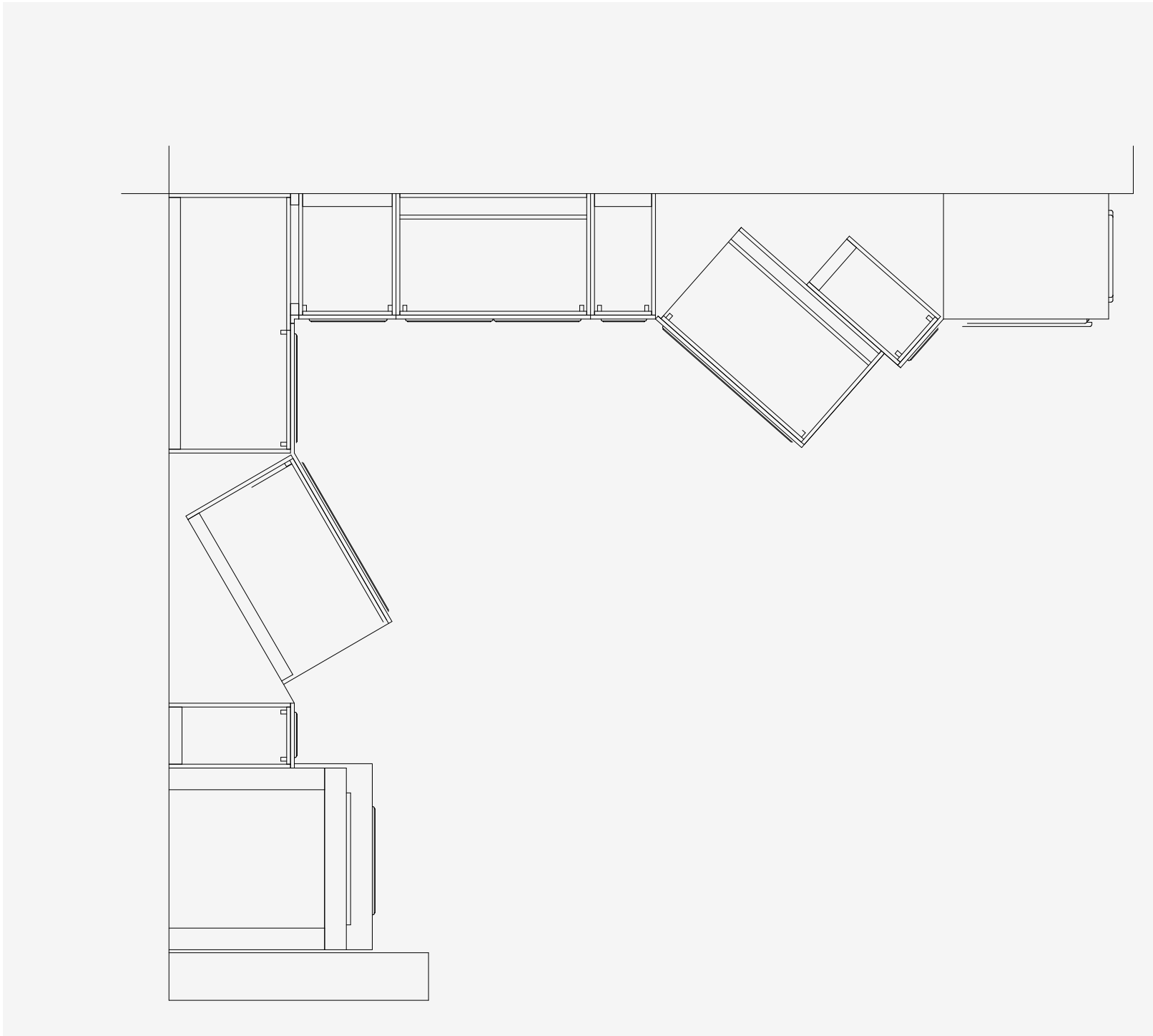
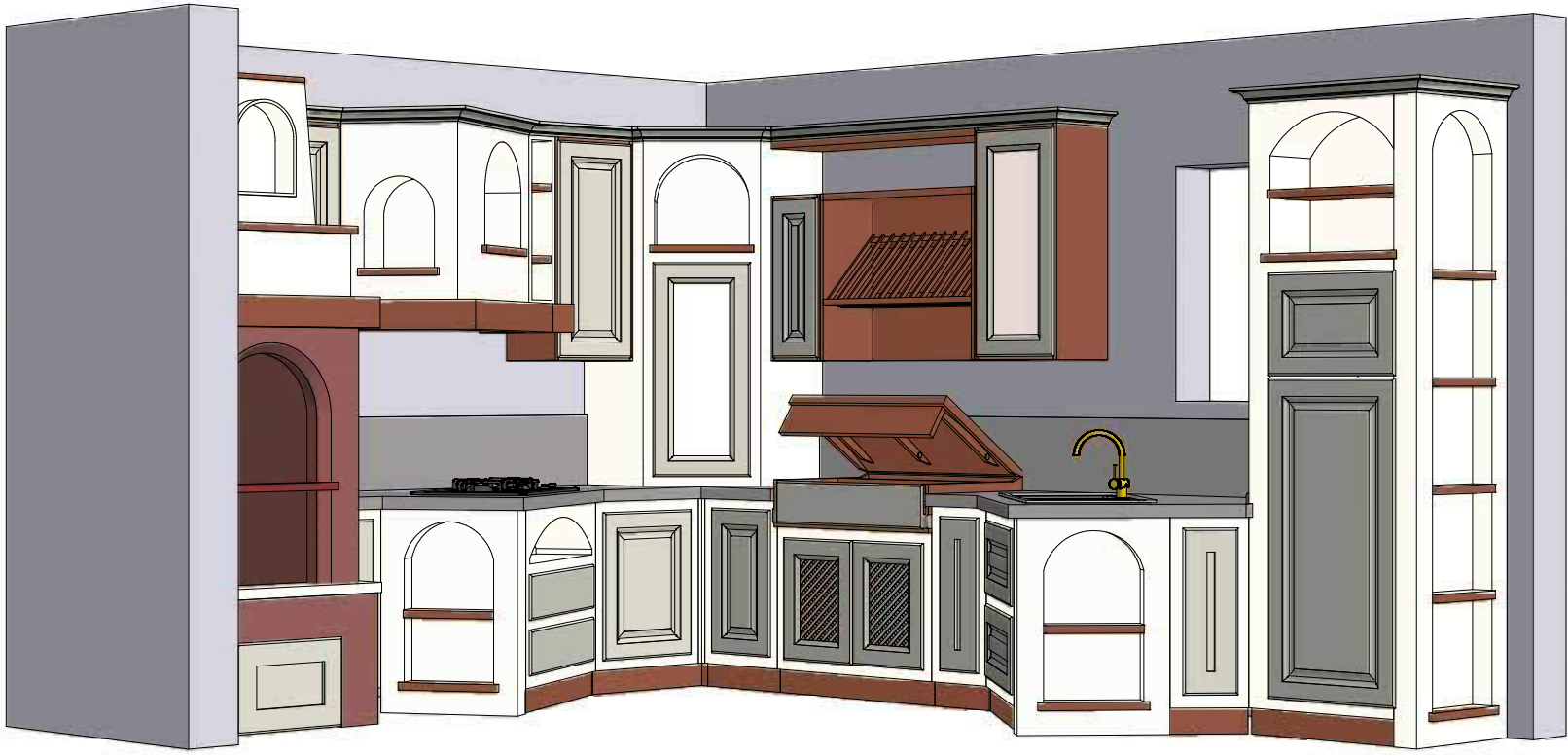

Composizione tipo / Composition type

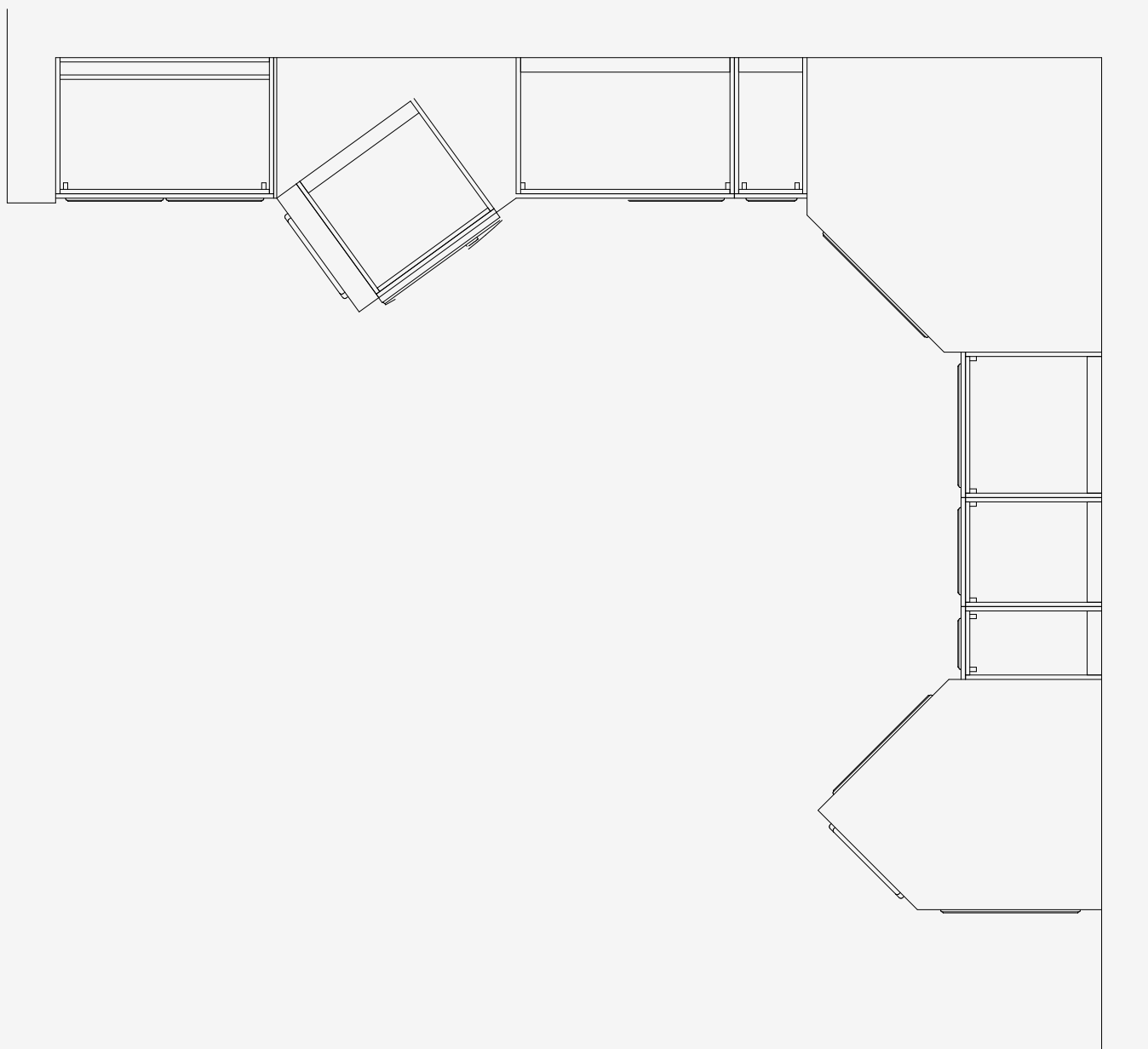

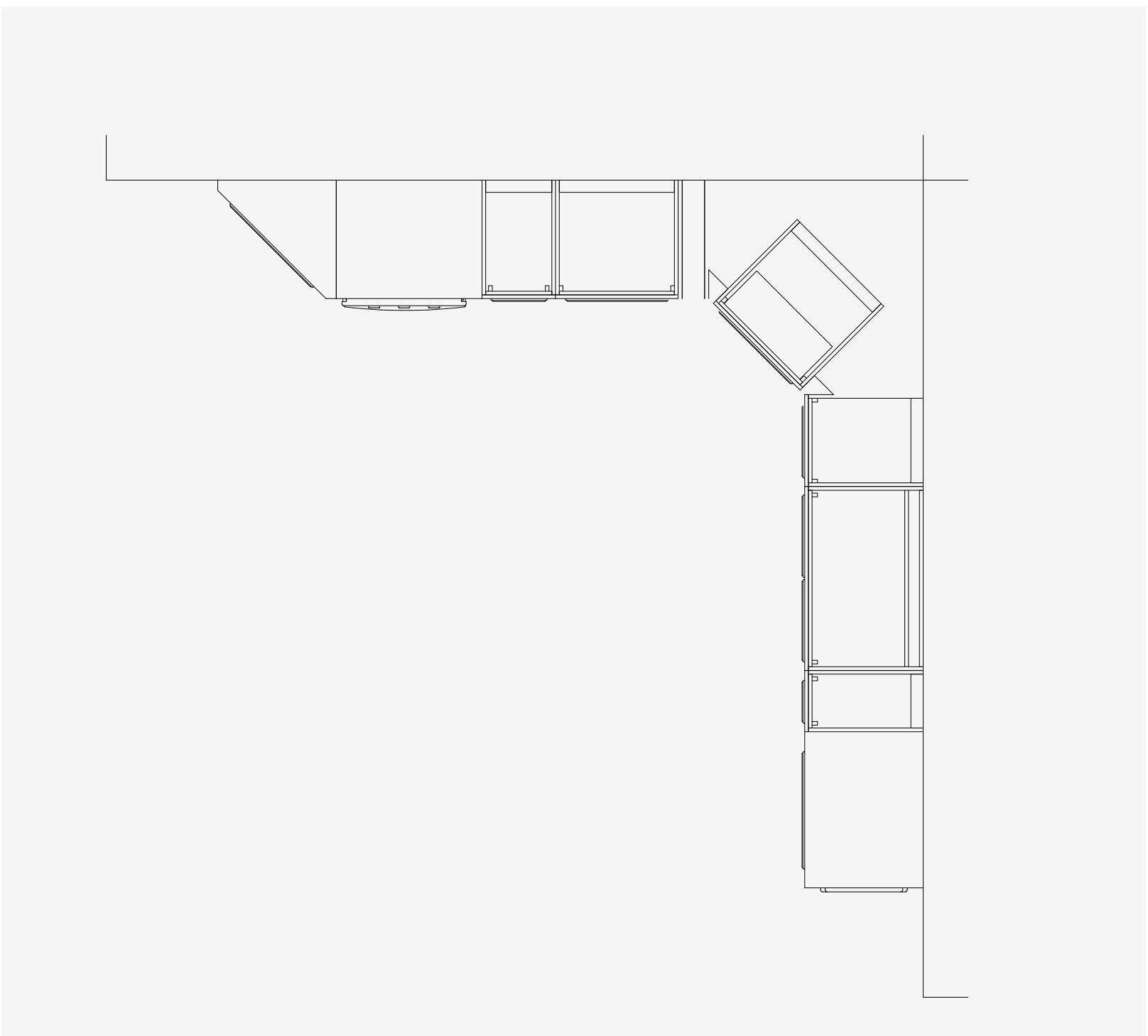
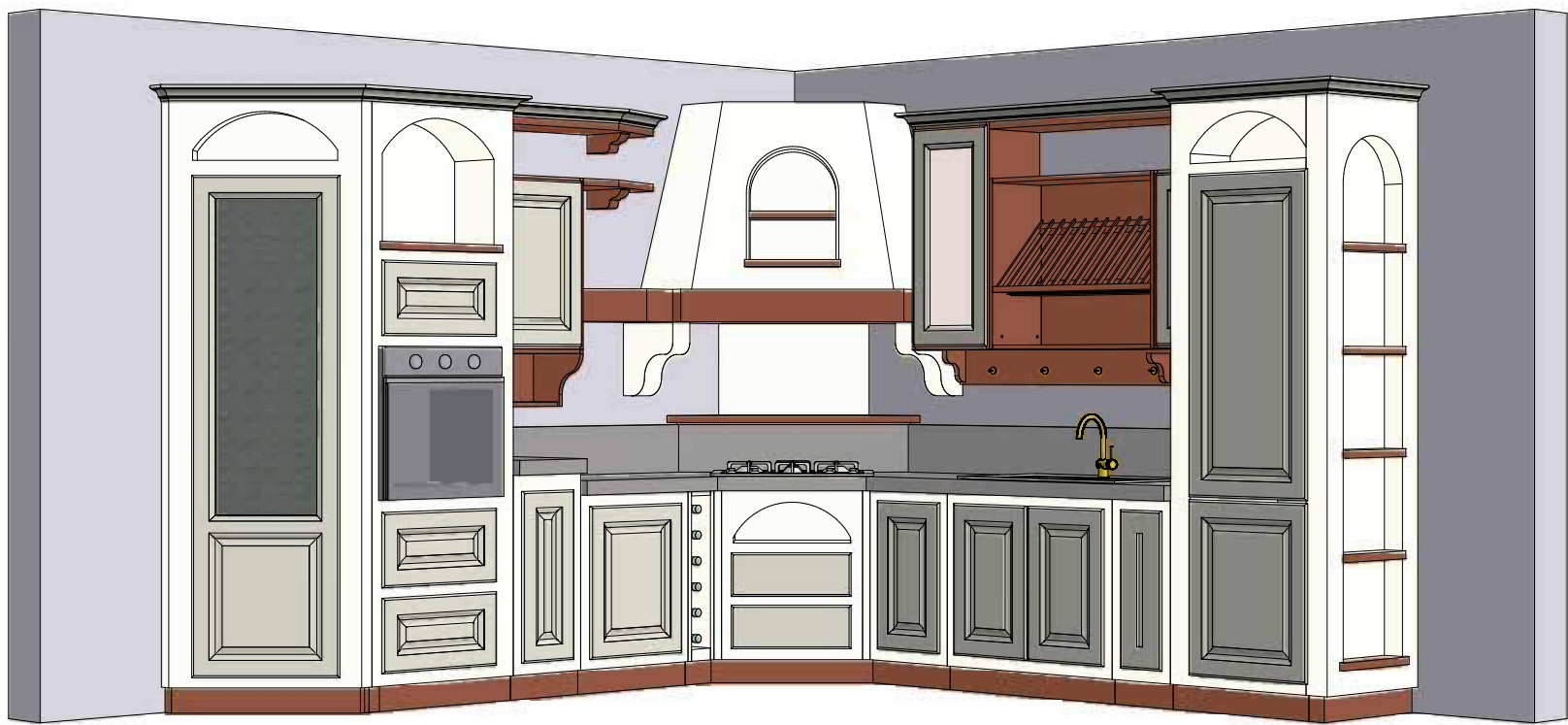

Composizione tipo / Composition type

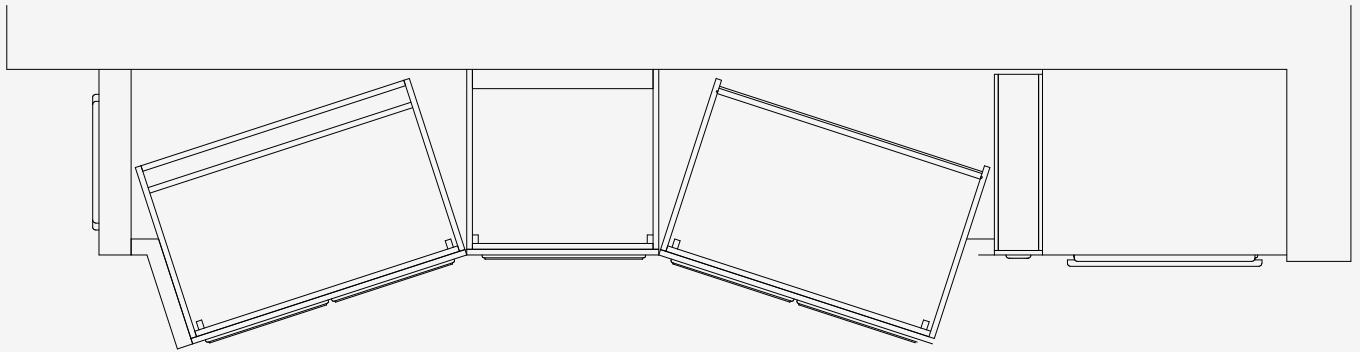
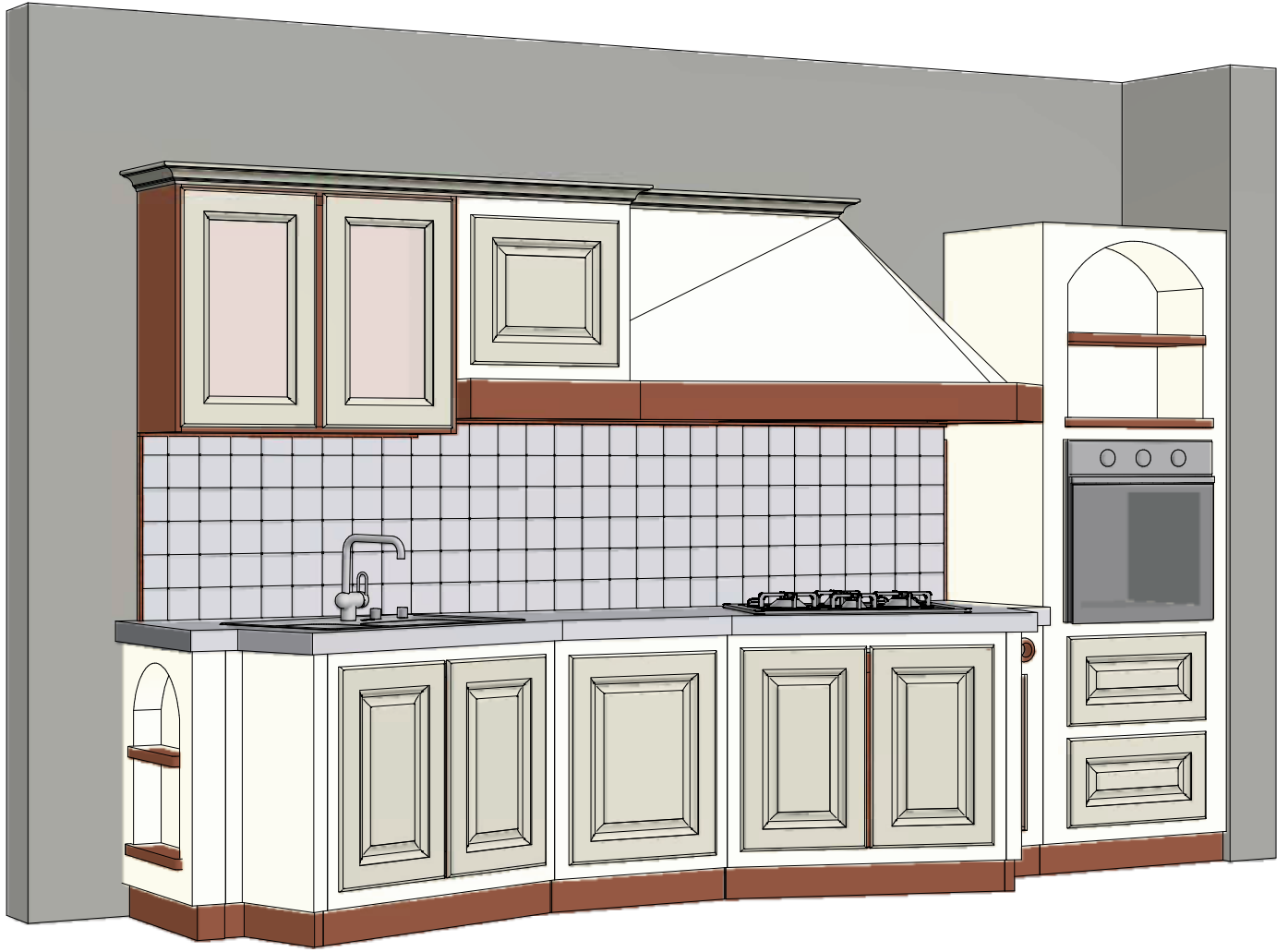

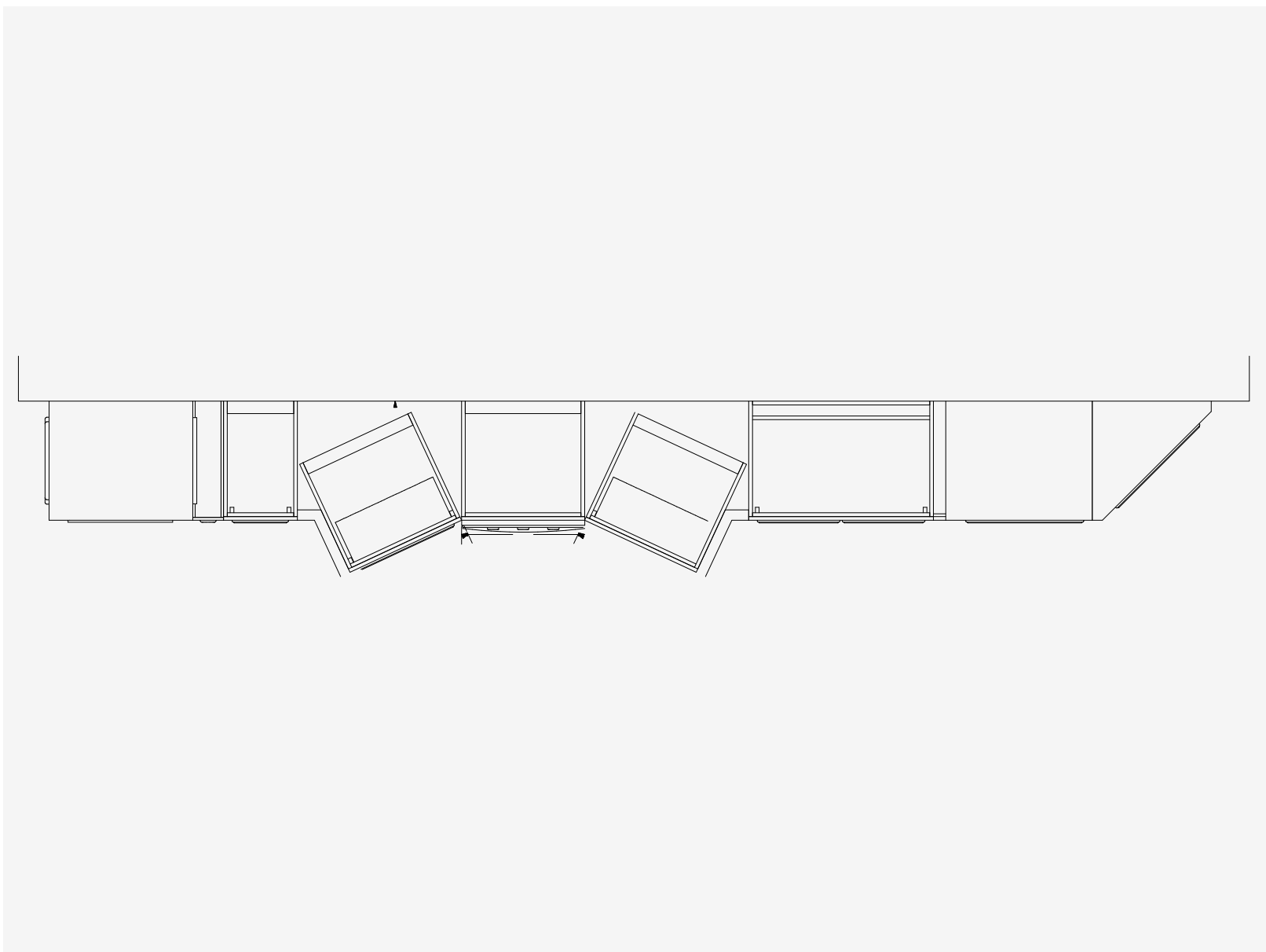

Composizione tipo / Composition type

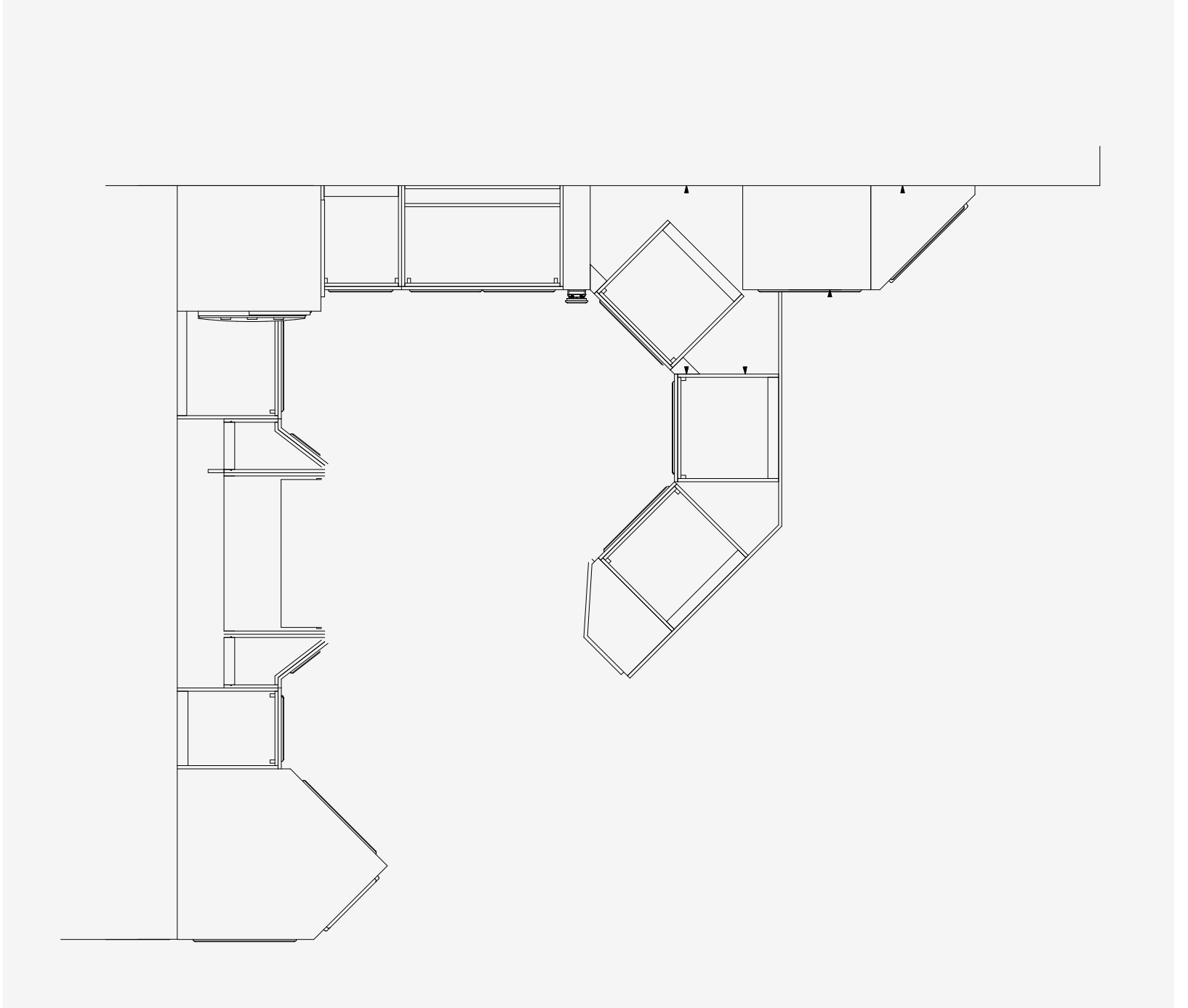
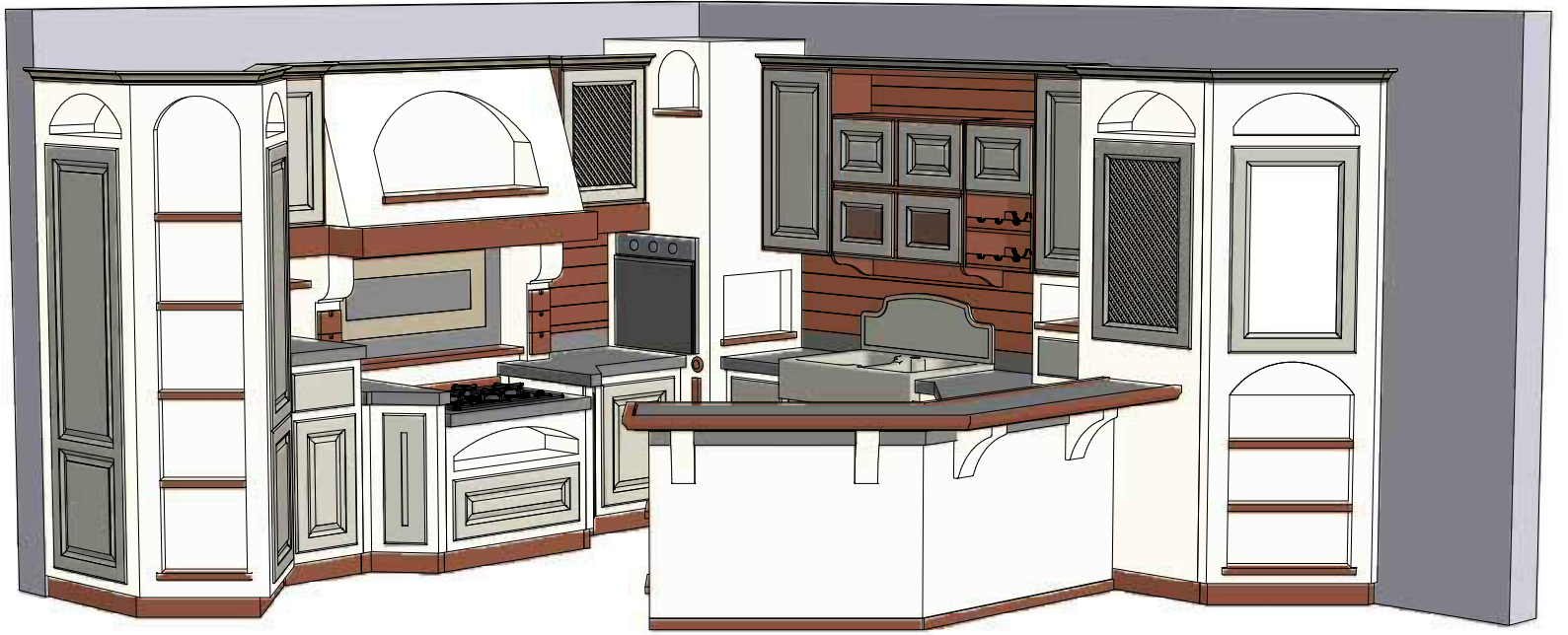

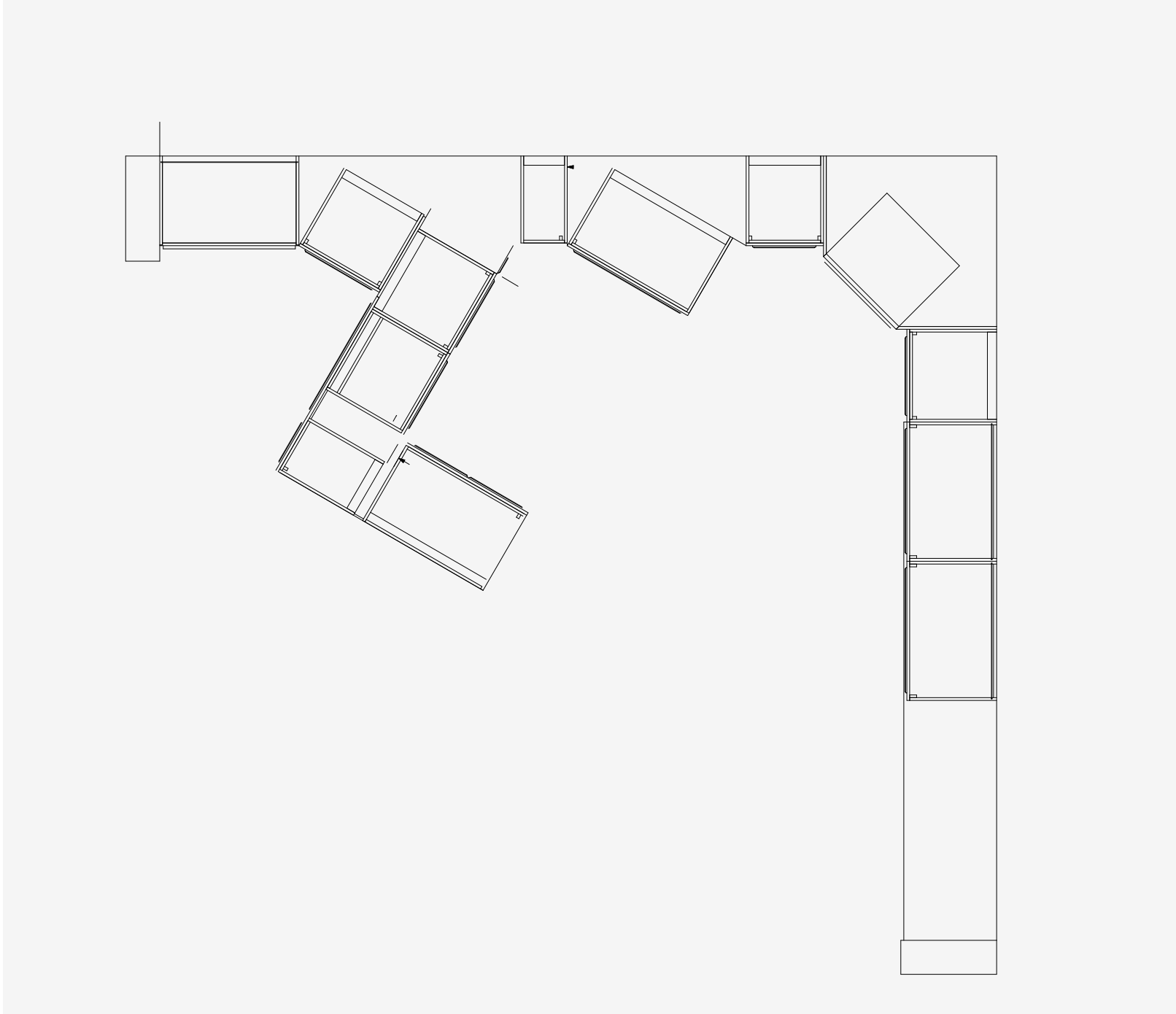
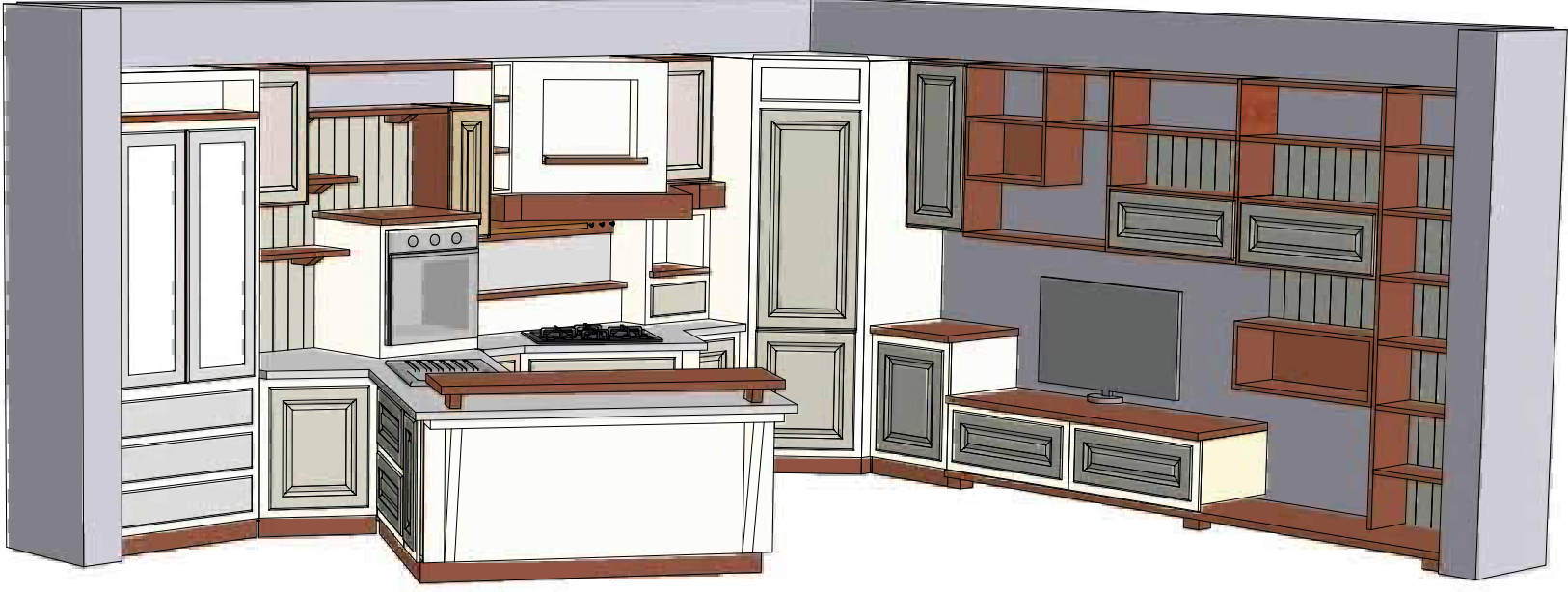

Composizione tipo / Composition type





140 ~ ELENA Bianco Shabby