



2022

unica

Unica



Unica è una cucina moderna, pratica e funzionale. Un modello versatile in grado di interpretare stili contemporanei diversi grazie alla ampia gamma di finiture disponibili.

UNICA is a modern, practical and functional kitchen. A versatile model, capable of interpreting different contemporaries styles thanks to the wide range of available finishes.

Anta squadrata con maniglia a gola

Square door with finger rail opening

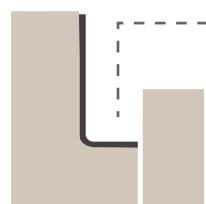

- gola tipo "elle"
"L" type finger rail

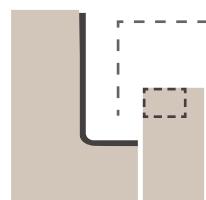

- gola tipo "elle" con maniglia incassata
"L" type finger rail with recessed handle



Anta con profilo per apertura con gola a “elle”

Door with profile for opening with “L” finger rail

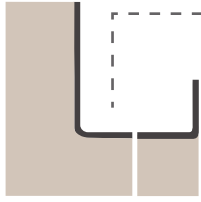

• gola tipo “elle”
“L” type finger rail



Anta con maniglia

Door with handle

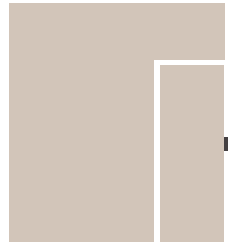

-----● **FRONTALE**
anta con
maniglia
frontale
door with front
handle

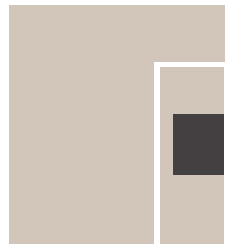

-----● **FRONTALE**
anta con
maniglia
incassata
door with
recessed handle



Head

Anta con maniglia applicata in testa
door with top-mounted handle

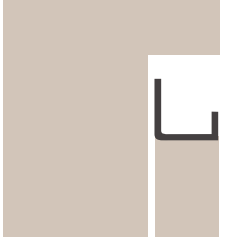

SP. 22 MM

CARATTERISTICHE TECNICHE

ANTE E FRONTALI CASSETTI

anta sp.22 mm costituita da un supporto di pannello di particelle di legno (conforme **US EPA TSCA Title VI**) stondate nei lati verticali raggio 7 mm e bordate polipropilene sp.10/10 in tinta nei lati orizzontali disponibili nei colori opachi:

phagos finitura chiselled venatura verticale: nuvola (opz.1567), kapok (opz.1560), vulcano (opz.1568), bianco (opz.1566)

finitura rovere naturale venatura verticale: perla (opz.5314)

finitura materica effetto pietra: pietra fulvus (opz.8867), pietra grey (opz.9642), pietra musk (opz.8403)

finitura effetto ossidato: platino (opz.9661)

finitura seta tinta unita: bianco assoluto (opz.7450), dove grey (opz.8971), ecru (opz.9641), grigio chiaro (opz.9640), antracite (opz.9643)

ANTE VETRO

telaio alluminio verniciato grigio selce sp.22 mm con vetro:
trasparente (opz.UNGT), satinato (opz.UNGS), bronzo satinato (opz.UNGB)

telaio alluminio verniciato silver dark sp.22 mm con vetro:
trasparente (opz.UNST), satinato (opz.UNSS), fumè satinato (opz.UNSF)

telaio alluminio verniciato nero sp.22 mm con vetro:
trasparente (opz.UNNT), satinato (opz.UNNS), fumè satinato (opz.UNNF)

PROFILI E GOLE

N.B.: per le finiture profili e gole vedi pag.18-19

MANIGLIE

vedi pag.24-28

STRUTTURE

ANTE: phagos bianco, bianco assoluto
nobilitato bianco (opz.001), schiena e ripiano bianco (opz.001)

ANTE: rovere perla, pietra grey, pietra musk, antracite, grigio chiaro
nobilitato argilla (opz.9690) schiena e ripiano argilla (opz.9690)

**ANTE: pietra fulvus, dove grey, ecru, ossidato platino, phagos nuvola,
phagos vulcano, phagos kapok**
nobilitato visone (opz.948M) schiena e ripiano visone (opz.948M)

a richiesta: nobilitato conchiglia (opz.8910) schiena e ripiano conchiglia (opz.8910)
nobilitato lavagna (opz.9620) schiena e ripiano lavagna (opz.9620)
nobilitato fango (opz.8860) schiena e ripiano fango (opz.8860)
nobilitato lino effetto tela (opz.8920) schiena e ripiano conchiglia (opz.8910)

MENSOLE

di serie: altezza 3,8 cm in laminato, bianco (opz.001), argilla (opz.9690), visone (opz.948M), conchiglia (opz.8910), lavagna (opz.9620), fango (opz.8860)

a richiesta: altezza 3,8 cm finiture come ante

ZOCCOLI

vedi pag.31



*per componenti si intendono tutte le strutture, alcune ante e alcuni complementi dei modelli.



LE STRUTTURE DELLE CUCINE SONO CONTRADDISTINTE DALLA CERTIFICAZIONE GREENGUARD GOLD, PER SODDISFARE GLI STANDARD PIU' RIGOROSI IN TERMINI DI LIVELLI DI EMISSIONE DI COMPOSTI ORGANICI VOLATILI (COV).



Melamine

TH. 22 MM

Neck	cod.	N35
Neck with handle	cod.	N36
Lux	cod.	L35
Bridge	cod.	B35
Head	cod.	B36

TECHNICAL FEATURES

DOORS AND DRAWERS FRONT

22 mm thick door consisting of a support of wood particle board (compliant with [US EPA TSCA Title VI](#)) rounded on the vertical sides with a radius of 7 mm and edged in polypropylene thickness 10/10 in the same color on the horizontal sides available in lacquered colors:

phagos chiselled finish vertical grain: cloud (opt.1567), kapok (opt.1560), volcano (opt.1568), white (opt.1566)

vertical grain natural oak finish: pearl (opt.5314)

material finish with stone effect: stone fulvus (opt.8867), stone grey (opt.9642), stone musk (opt.8403)

oxidized effect finish: platinum (opt.9661)

solid color silk finish: absolute white (opt.7450), grey dove (opt.8971), ecru (opt.9641), clear grey (opt.9640), anthracite (opt.9643)

GLASS DOORS

22 mm thick flint grey-coated aluminum frame with glass:
transparent (opt.UNGT), satin (opt.UNGS), satin bronze (opt.UNGB)

22 mm thick dark silver-coated aluminum frame with glass:
transparent (opt.UNST), satin (opt.UNSS), smoked satin (opt.UNSF)

22 mm thick black-coated aluminum frame with glass:
transparent (opt.UNNT), satin (opt.UNNS), smoked satin (opt.UNNF)

PROFILES AND FINGER RAILS

Note: for the profiles and finger rails finishes see page 18-19

HANDLES

see on page 24-28

STRUCTURES

DOORS: phagos white, absolute white
melamine-coated white (opt.001), white back panel and shelf (opt.001)

DOORS: oak pearl, stone grey, stone musk, anthracite, clear grey
melamine-coated clay (opt.9690), clay back panel and shelf (opt.9690)

DOORS: stone fulvus, grey dove, ecru, oxidized platinum, phagos cloud, phagos volcano, phagos kapok
melamine-coated mink (opt.948M), mink back panel and shelf (opt.948M)

on request:
melamine-coated shell (opt.8910), shell back panel and shelf (opt.8910)
melamine-coated slate grey (opt.9620), slate grey back panel and shelf (opt.9620)
melamine-coated mud (opt.8860), mud back panel and shelf (opt.8860)
linen melamine-coated canvas effect (opt.8920), shell back panel and shelf (opt.8910)

SHELVES

standard: height 3.8 cm, made of laminate, white (opt.001), clay (opt.9690), mink (opt.948M), shell (opt.8910), slate grey (opt.9620), mud (opt.8860)

on request: height 3.8 cm, finishes as doors

PLINTHS

see on page 31

Melaminico fascia "A"

Melamine band "A"

SP. 22 MM TH. 22 MM



ante phagos finitura chiselled
chiselled finish phagos doors



nuvola (opz.1567)
cloud

bianco (opz.1566)
white

anta finitura rovere naturale
natural oak finish door



perla (opz.5314)
pearl

anta finitura effetto ossidato
oxidized effect finish door



platino (opz.9661)
platinum

anta finitura materica
textured finish door



pietra grey (opz.9642)
stone grey

ante finitura seta tinta unita
solid color silk finish doors

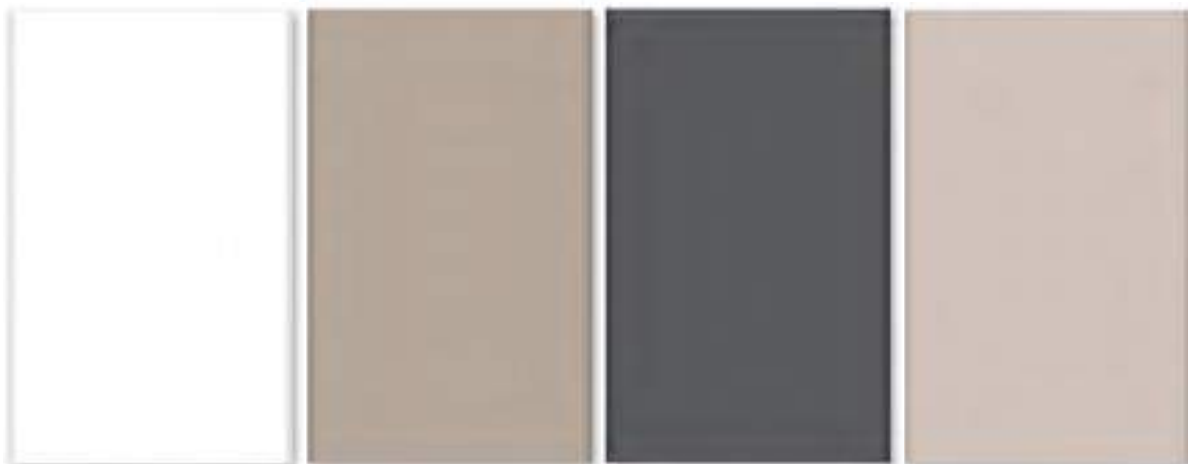

bianco assoluto (opz.7450)
absolute white

ecru (opz.9641)
ecru

antracite (opz.9643)
anthracite

dove grey (opz.8971)
grey dove

Neck	cod.	N35
Neck con maniglia with handle	cod.	N36
Lux	cod.	L35
Bridge	cod.	B35
Head	cod.	B36

Melaminico fascia "B"

Melamine band "B"

SP. 22 MM TH. 22 MM

ante phagos finitura chiselled
chiselled finish phagos doors



kapok (opz.1560)
kapok

vulcano (opz.1568)
volcano

anta finitura materica
textured finish door



pietra fulvus (opz.8867)
stone fulvus

pietra musk (opz.8403)
stone musk

ante finitura seta tinta unita
solid color silk finish doors



grigio chiaro (opz.9640)
clear grey

Neck	cod.	N35
Neck con maniglia with handle	cod.	N36
Lux	cod.	L35
Bridge	cod.	B35
Head	cod.	B36

SP. 22 MM TH.22 MM

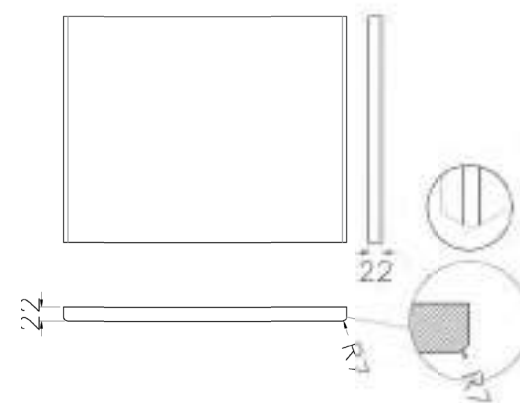

particolare anta
detail of door

Telaio alluminio

Aluminium frame

telaio alluminio verniciato grigio selce sp.22 mm vetro trasparente, satinato, bronzo satinato

22 mm-thick flint grey-coated aluminium frame with transparent, satin, satin bronze glass



telaio grigio selce con vetro trasparente (opz.UNGT)
flint grey frame with transparent glass (opt.UNGT)



telaio grigio selce con vetro satinato (opz.UNGS)
flint grey frame with satin glass (opt.UNGS)



telaio grigio selce con vetro bronzo satinato (opz.UNGB)
flint grey frame with satin bronze glass (opt.UNGB)



particolare anta vetro
detail glass door

telaio alluminio verniciato silver dark sp.22 mm vetro trasparente, satinato, fumè satinato

22 mm-thick dark silver-coated aluminium frame with transparent, satin, smoked satin glass



telaio silver dark con vetro trasparente (opz.UNST)
dark silver frame with transparent glass (opt.UNST)



telaio silver dark con vetro satinato (opz.UNSS)
dark silver frame with satin glass (opt.UNSS)



telaio silver dark con vetro fumè satinato (opz.UNSF)
dark silver frame with smoked satin glass (opt.UNSF)



particolare anta vetro
detail glass door

Telaio alluminio

Aluminium frame

telaio alluminio verniciato nero sp.22 mm vetro trasparente, satinato, fumè satinato

22 mm-thick black-coated aluminium frame with transparent, satin, smoked satin glass



telaio nero con vetro
trasparente (opz.UNNT)
black frame with transparent
glass (opt.UNNT)



telaio nero con vetro
satinato (opz.UNNS)
black frame with satin glass
(opt.UNNS)



telaio nero con vetro
fumè satinato (opz.UNNF)
black frame with smoked
satin glass (opt.UNNF)



particolare anta vetro
detail glass door

Telaio alluminio con maniglia

Aluminum frame with handle

telaio alluminio verniciato grigio selce sp.22 mm vetro trasparente, satinato, bronzo satinato
22 mm-thick flint grey-coated aluminium frame with transparent, satin, satin bronze glass



telaio grigio selce con vetro trasparente (opz.UNGT)
flint grey frame with transparent glass (opt.UNGT)



telaio grigio selce con vetro satinato (opz.UNGS)
flint grey frame with satin glass (opt.UNGS)



telaio grigio selce con vetro bronzo satinato (opz.UNGB)
flint grey frame with satin bronze glass (opt.UNGB)



particolare anta vetro
detail glass door

telaio alluminio verniciato silver dark sp.22 mm vetro trasparente, satinato, fumè satinato
22 mm-thick dark silver-coated aluminium frame with transparent, satin, smoked satin glass



telaio silver dark con vetro trasparente (opz.UNST)
dark silver frame with transparent glass (opt.UNST)



telaio silver dark con vetro satinato (opz.UNSS)
dark silver frame with satin glass (opt.UNSS)



telaio silver dark con vetro fumè satinato (opz.UNSF)
dark silver frame with smoked satin glass (opt.UNSF)



particolare anta vetro
detail glass door

Telaio alluminio con maniglia

Aluminum frame with handle

telaio alluminio verniciato nero sp.22 mm vetro trasparente, satinato, fumè satinato

22 mm-thick black-coated aluminium frame with transparent, satin, smoked satin glass



telaio nero con vetro trasparente (opz.UNNT)
black frame with transparent glass (opt.UNNT)



telaio nero con vetro satinato (opz.UNNS)
black frame with satin glass (opt.UNNS)



telaio nero con vetro fumè satinato (opz.UNNF)
black frame with smoked satin glass (opt.UNNF)



particolare anta vetro
detail glass door



Esempio di anta unica a vetro per colonna con maniglia centrale
Example of single glass door for column with central handle

Finiture gole / Finger rails finishes

Neck

**Finiture gole
spazzolate**
Finger rails
brushed finishes



titanio ossidato (opz.414)
titanium oxidized
(opt.414)



brill (opz.412)
brill (opt.412)

**Finiture gole
verniciate a polvere
opache**
Matt finger rails
powder coated finishes

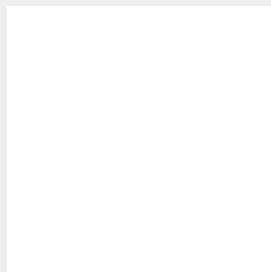

bianco assoluto (opz.740S)
absolute white
(opt.740S)

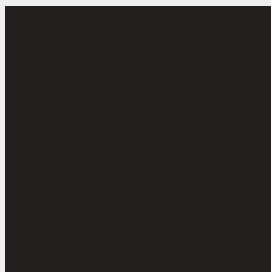

nero (opz.7892)
black (opt.7892)

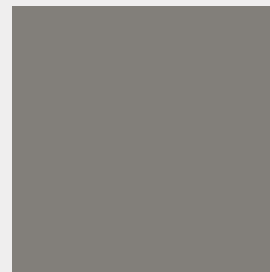

fumo (opz.9531)
smoke (opt.9531)

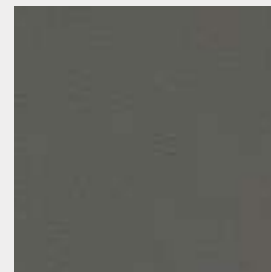

silver dark (opz.9507)
dark silver (opt.9507)

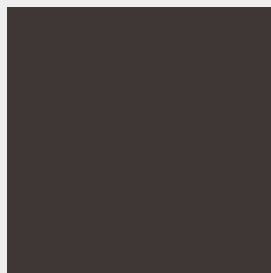

ghisa (opz.9509)
cast iron (opt.9509)



grigio selce (opz.SEL)
flint grey (opt.SEL)

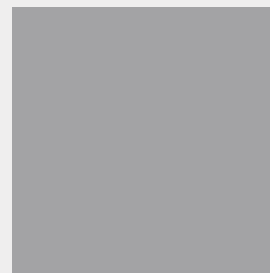

grigio traffico (opz.9511)
traffic grey (opt.9511)



argilla (opz.9503)
clay (opt.9503)

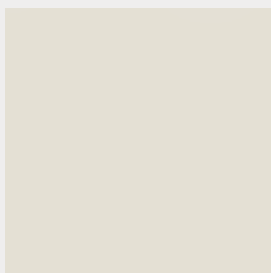

lino (opz.W770)
linen (opt.W770)

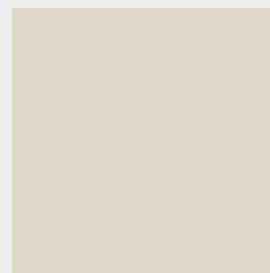

conchiglia (opz.7403)
seashell (opt.7403)

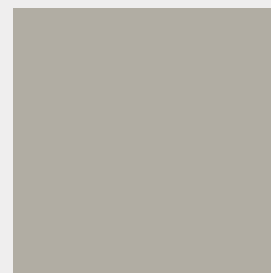

grigio kenya (opz.9501)
kenya grey (opt.9501)

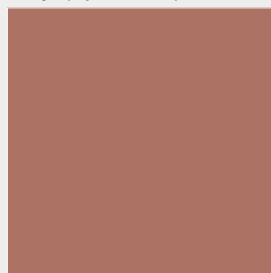

rosso persia (opz.8165)
persia red (opt.8165)

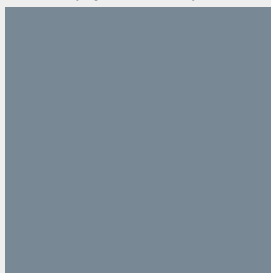

azzurro nube (opz.8379)
cloud blue (opt.8379)

Finiture gole / Finger rails finishes

LUX

**Finiture gole
spazzolate**
Finger rails
brushed finishes



titanio ossidato (opz.414)
titanium oxidized
(opt.414)

**Finiture gole
verniciate a polvere
opache**
Matt finger rails
powder coated finishes



rosso persia (opz.8165)
persia red (opt.8165)

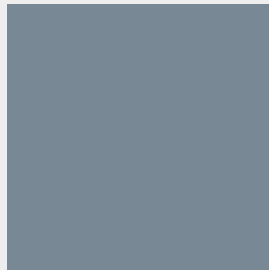

azzurro nube (opz.8379)
cloud blue (opt.8379)











nero (opz.7892)
black (opt.7892)

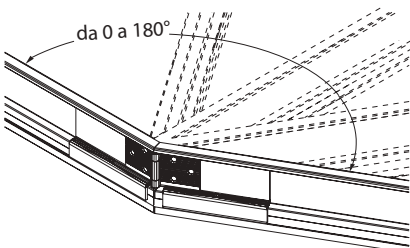

silver dark (opz.9507)
dark silver (opt.9507)

GOLA "ELLE" ORIZZONTALE SOTTOTOP

UNDERMOUNT HORIZONTAL "ELLE" FINGER RAIL



	COD.			COD.		
<p>Gola sottotop tipo "A" Type "A" undermount finger rail</p>  <p style="text-align: right;">al ml per lm</p>	G950010			<p>Angolo interno a 90° per gola tipo "A" 90° interior corner for "A" type finger rail</p>  <p style="text-align: right;">cadauno each</p>	G950050	
<p>Terminale aperto dx o sx per gola tipo "A" da utilizzare a fine composizione RH or LH open end for type "A" finger rail to be placed at the end of the composition</p>  <p style="text-align: right;">terminale DX RH end terminale SX LH end</p>	G950021			<p>Angolare con snodo per unione fuori squadra per gola tipo "A" Corner piece with joint for out-of-plumb joining for type "A" finger rail</p>  		
<p>Terminale chiuso dx o sx per gola tipo "A" da utilizzare solo tra basi e colonne RH or LH closure for type "A" finger rail to be placed only between base units and column</p>  <p style="text-align: right;">terminale DX RH end terminale SX LH end</p>	G950031					
<p>Terminale chiuso dx o sx per gola tipo "A" da utilizzare solo tra basi e colonne RH or LH closure for type "A" finger rail to be placed only between base units and column</p>  <p style="text-align: right;">terminale DX RH end terminale SX LH end</p>	G950032					G950060
<p>Coppia angolari per kit raccordo base angolo 110x110 N:B: obbligatori Couple corner piece for fitting kit corner base unit 110x110 Note: obligatory</p>  <p style="text-align: center;">SX LH DX RH</p> <p style="text-align: right;">in alluminio aluminium</p> <p style="text-align: right;">angolare DX RH corner piece angolare SX LH corner piece</p>	G950058					
	G950059					





GOLA "ELLE" ORIZZONTALE INTERMEDIA

INTERMEDIATE HORIZONTAL "ELLE" FINGER RAIL

GOLE "ELLE" VERTICALI PER COLONNE

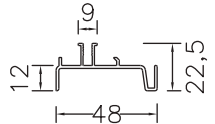
VERTICAL "ELLE" FINGER RAILS FOR COLUMNS

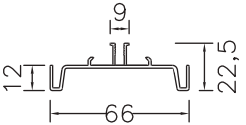
	COD.	
<p>Gola intermedia tipo "B" Type "B" intermediate finger rail</p> 		
al ml per lm	G950110	
<p>Terminale aperto dx o sx per gola tipo "B" da utilizzare a fine composizione RH or LH open end for type "B" finger rail to be placed at the end of the composition</p> 		
terminale DX RH end	G950121	
terminale SX LH end	G950122	
<p>Terminale chiuso dx o sx per gola tipo "B" da utilizzare solo tra cassettiere e lavastoviglie/colonne RH or LH closure for type "B" finger rail to be placed only between drawer units and dishwasher/columns</p> 		
terminale DX RH end	G950131	
terminale SX LH end	G950132	

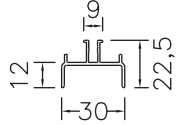
	COD.	
<p>Mezza gola verticale tipo "C" (completa di distanziale) Type "C" half vertical finger rail (complete with spacer)</p>   <p>sezione mezza gola tipo "C" cross section of type "C" finger rail</p>		
Piedi H 13 H 96	G950310	
H 132	G950330	
H 204	G950350	
H 228	G950370	
Piedi H 6 H 108	G950320	
H 144	G950340	
H 216	G950360	
<p>Gola verticale intermedia tipo "D" (completa di distanziale) Type "D" intermediate vertical finger rail (complete with spacer)</p>   <p>sezione gola tipo "D" cross section of type "D" finger rail</p>		
Piedi H 13 H 96	G950410	
H 132	G950430	
H 204	G950450	
H 228	G950470	
Piedi H 6 H 108	G950420	
H 144	G950440	
H 216	G950460	
<p>Gola verticale laterale tipo "E" (completa di distanziale) Type "E" lateral vertical finger rail (complete with spacer)</p>   <p>sezione gola tipo "E" cross section of type "E" finger rail</p>		
Piedi H 13 H 96	G950510	
H 132	G950530	
H 204	G950550	
H 228	G950570	
Piedi H 6 H 108	G950520	
H 144	G950540	
H 216	G950560	

NOZIONI UTILI - gole "elle" orizzontali per basi

USEFUL INFORMATION - HORIZONTAL "ELLE" FINGER RAILS FOR BASE UNITS

VISTA FRONTALE ZOCCOLO H 13 PER BASI H 88

FRONT VIEW PLINTH H 13 FOR BASE UNITS H 88

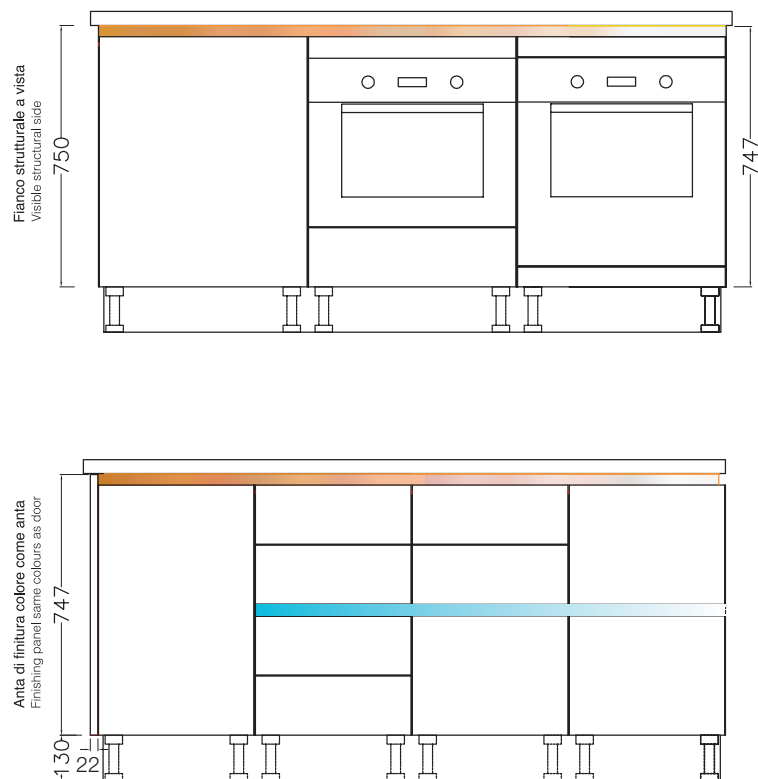

VISTA LATERALE (sezione) ZOCCOLO H 13 PER BASI H 88

SIDE VIEW (CROSS SECTION) PLINTH H 13 FOR BASE UNITS H 88

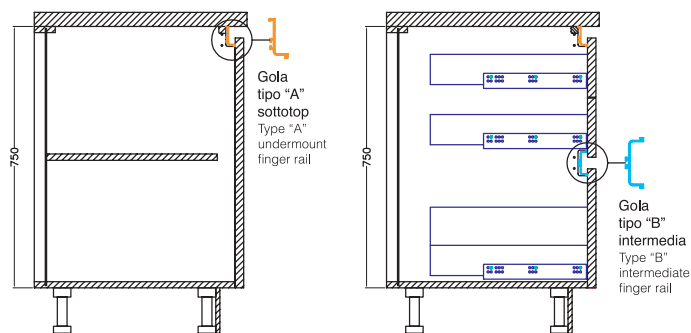

VISTA DALL'ALTO

TOP VIEW



Composizione con ante di finitura laterali: alla dimensione finale della cucina, sommare sempre lo spessore delle ante di finitura (ogni anta 2,2 cm)

Composition with side finishing panels: to the final size of the kitchen, always add the thickness of the finishing panels (each panel 22 mm)

NOZIONI UTILI - gole "elle" verticali per colonne

USEFUL INFORMATION - VERTICAL "ELLE" FINGER RAILS FOR COLUMNS

VISTA FRONTALE ZOCCOLO H 13

FRONT VIEW PLINTH H 13

N.B.: PER LA VERSIONE LUX SULLE COLONNE IL PROFILO ANTA E' SEMPRE VERTICALE
NOTE: DOOR PROFILE ON THE COLUMNS FOR LUX VERSION IS ALWAYS VERTICAL

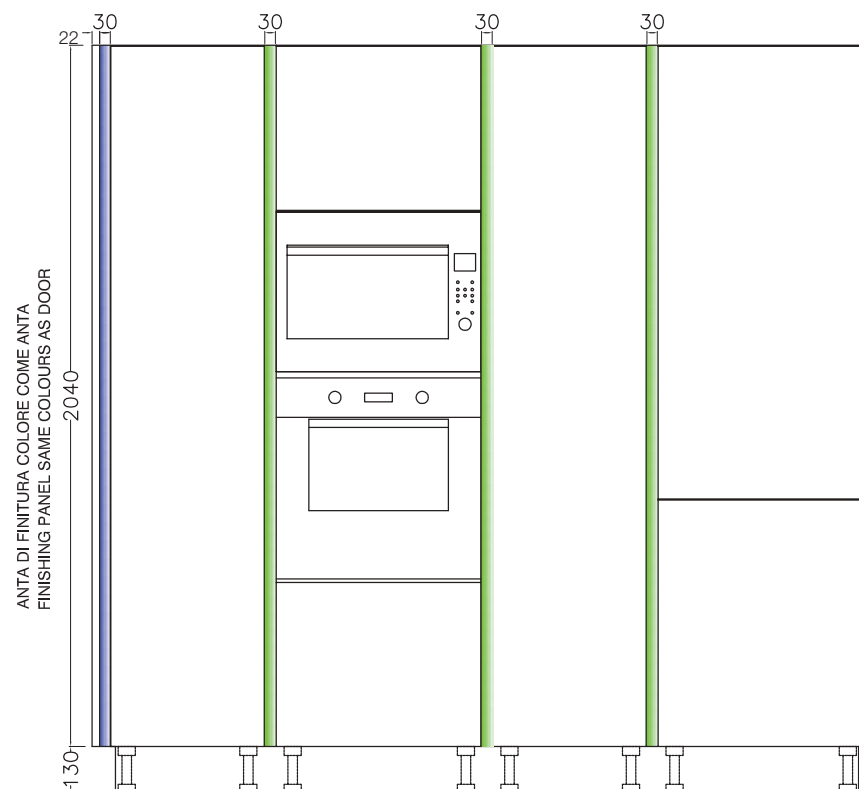

VISTA DALL'ALTO

TOP VIEW

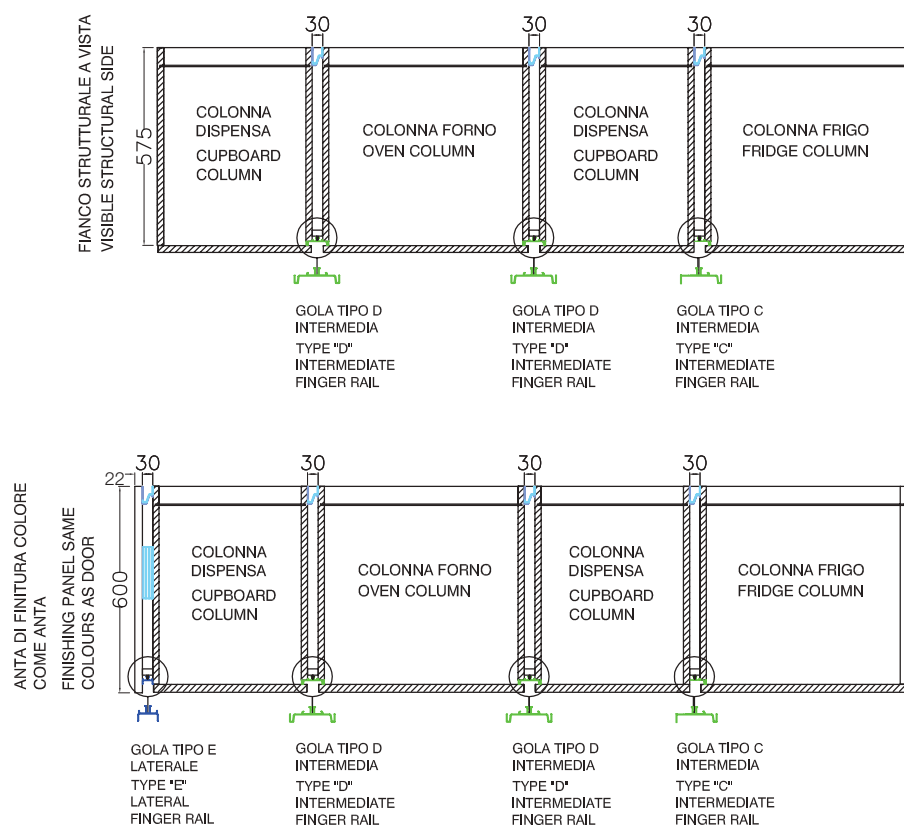

Composizione fianco strutturale
a vista come anta:
alla dimensione finale della cucina,
sommare sempre lo spessore dei
distanziali tra le colonne
(ogni distanziale 3 cm)

Composition with visible side panel to match door:
to the final size of the kitchen, always add the thickness
of the spacers between the two columns (each spacer 3 cm)

Composizione con ante di finitura
laterali, alla dimensione finale della
cucina, sommare sempre lo spessore
dei distanziali tra le colonne
(ogni distanziale 3 cm) e lo spessore
delle ante di finitura (ogni anta 2,2 cm)

Composition with side finishing panels to the final size of the
kitchen, always add the thickness of the spacer between the
two columns (each spacer 3 mm) and the thickness of the
finishing panels (each panel 22 mm)

DI SERIE STANDARD



Maniglia U1
 anta L 15 → passo 96 mm
 anta L 30 a L 45 → passo 160 mm
 anta da L 60 a L 120 → passo 320 mm

Handle U1
 door W 15 → centre-to-centre distance 96 mm
 door W 30 to W 45 → centre-to-centre distance 160 mm
 door from W 60 to W 120 → centre-to-centre distance 320 mm

Maniglia U1S finitura silver dark
 Handle U1S dark silver finish

Maniglia U1N finitura nero
 Handle U1N black finish

Maniglia U1K finitura nichel satinato
 Handle U1K satin nickel finish

N.B.: per la colonna Nook è consigliato l'abbinamento con la maniglia 940 finitura titanio
Note: the combination is recommended for the Nook column with the 940 titanium finish handle

A RICHIESTA ON REQUEST



Maniglia U3
 anta L 15 → passo 96 mm
 anta L 30 a L 45 → passo 160 mm
 anta da L 60 a L 120 → passo 320 mm

Handle U3
 door W 15 → centre-to-centre distance 96 mm
 door W 30 to W 45 → centre-to-centre distance 160 mm
 door from W 60 to W 120 → centre-to-centre distance 320 mm

Maniglia U3T finitura titanio
 Handle U3T titanium finish

A RICHIESTA ON REQUEST



Maniglia U2
 anta L 15 → passo 64 mm
 anta L 30 a L 45 → passo 160 mm
 anta da L 60 a L 120 → passo 320 mm

Handle U2
 door W 15 → centre-to-centre distance 64 mm
 door W 30 to W 45 → centre-to-centre distance 160 mm
 door from W 60 to W 120 → centre-to-centre distance 320 mm

Maniglia U2S finitura silver dark
 Handle U2S dark silver finish

Maniglia U2G finitura grigio selce
 Handle U2G flint grey finish

N.B.: per la colonna Nook è consigliato l'abbinamento con la maniglia 940 finitura silver dark
Note: the combination is recommended for the Nook column with the 940 dark silver finish handle

A RICHIESTA ON REQUEST



Maniglia U4
 anta L 15 → passo 160 mm in verticale
 anta L 30 a L 45 → passo 160 mm
 anta da L 60 a L 120 → passo 320 mm

Handle U4
 door W 15 → centre-to-centre distance 160 mm vertical
 door W 30 to W 45 → centre-to-centre distance 160 mm
 door from W 60 to W 120 → centre-to-centre distance 320 mm

Maniglia U4T finitura titanio
 Handle U4T titanium finish

A RICHIESTA ON REQUEST



Maniglia U5
 anta L 15 → passo 160 mm in verticale
 anta L 30 a L 45 → passo 160 mm
 anta da L 60 a L 120 → passo 320 mm

Handle U5
 door W 15 → centre-to-centre distance 160 mm vertical
 door W 30 to W 45 → centre-to-centre distance 160 mm
 door from W 60 to W 120 → centre-to-centre distance 320 mm

Maniglia U5F finitura grafite spazzolato
 Handle U5F brushed graphite finish

N.B.: per la colonna Nook è consigliato l'abbinamento con la maniglia 940 finitura silver dark
Note: the combination is recommended for the Nook column with the 940 dark silver finish handle

A RICHIESTA ON REQUEST



Maniglia U6
 anta L 15 → passo 96 mm
 anta L 30 a L 45 → passo 160 mm
 anta da L 60 a L 120 → passo 320 mm

Handle U6
 door W 15 → centre-to-centre distance 96 mm
 door W 30 to W 45 → centre-to-centre distance 160 mm
 door from W 60 to W 120 → centre-to-centre distance 320 mm

Maniglia U6R finitura tortora
 Handle U6R dove grey finish

Maniglia U6N finitura nero
 Handle U6N black finish

Maniglia U6K finitura nichel satinato
 Handle U6K satin nickel finish

N.B.: per la colonna Nook è consigliato l'abbinamento con la maniglia 940 finitura titanio
Note: the combination is recommended for the Nook column with the 940 titanium finish handle

A RICHIESTA ON REQUEST



Maniglia U7 ad incasso
 anta L 15 → passo 64 mm
 anta L 30 a L 45 → passo 160 mm
 anta da L 60 a L 120 → passo 288 mm

Built-in handle U7
 door W 15 → centre-to-centre distance 64 mm
 door W 30 to W 45 → centre-to-centre distance 160 mm
 door from W 60 to W 120 → centre-to-centre distance 288 mm

Maniglia U7R finitura tortora
 Handle U7R dove grey finish

N.B.: per la colonna Nook è consigliato l'abbinamento con la maniglia 940 finitura titanio
 Note: the combination is recommended for the Nook column with the 940 titanium finish handle

A RICHIESTA ON REQUEST



Maniglia 947 ad incasso
 anta L 15 → dimensioni L 85
 anta da L 30 a L 45 → dimensioni L 190
 anta da L 60 a L 120 → dimensioni L 340

Built-in handle 947
 door W 15 → dimensions W 85
 door from W 30 to W 45 → dimensions W 190
 door from W 60 to W 120 → dimensions W 340

Maniglia 947S finitura silver dark
 Handle 947S dark silver finish

Maniglia 947T finitura titanio
 Handle 947T titanium finish

A RICHIESTA ON REQUEST



Maniglia U9
 anta L 15 → passo 64 mm
 anta L 30 a L 45 → passo 160 mm
 anta da L 60 a L 120 → passo 320 mm

Handle U9
 door W 15 → centre-to-centre distance 64 mm
 door W 30 to W 45 → centre-to-centre distance 160 mm
 door from W 60 to W 120 → centre-to-centre distance 320 mm

Maniglia U9K finitura nichel satinato
 Handle U9K satin nickel finish

N.B.: per la colonna Nook è consigliato l'abbinamento con la maniglia 940 finitura titanio
 Note: the combination is recommended for the Nook column with the 940 titanium finish handle

A RICHIESTA ON REQUEST



Maniglia 940 ad incasso
 dimensioni mm L 182 H 47
N.B.: utilizzata anche per colonne nook

Built-in handle 940
 dimensions W 182 H 47 mm
 Note: also used for nook columns

Maniglia 940T finitura titanio
 Handle 940T titanium finish

Maniglia 940P finitura rosso persia
 Handle 940P persia red finish

Maniglia 940Z finitura azzurro nube
 Handle 940Z cloud blue finish

Maniglia 940S finitura silver dark
 Handle 940S dark silver finish

Maniglia 940N finitura nero
 Handle 940N black finish

A RICHIESTA ON REQUEST



Maniglia U8
 anta L 15 → passo 32 mm
 anta L 30 a L 40 → passo 96 mm
 anta da L 45 a L 60 → passo 224 mm
 anta da L 65 a L 120 → passo 384 mm

Handle U8
 door W 15 → centre-to-centre distance 32 mm
 door W 30 to W 40 → centre-to-centre distance 96 mm
 door W 45 to W 60 → centre-to-centre distance 224 mm
 door from W 65 to W 120 → centre-to-centre distance 384 mm

Maniglia U8S finitura silver dark
 Handle U8S dark silver finish

Maniglia U8T finitura titanio
 Handle U8T titanium finish

MANIGLIE HANDLES

Neck con maniglia
with handle

DI SERIE STANDARD

Maniglia finitura titanio ossidato (opz.962T)
anta L 15 dimensioni mm L 100 H 18
anta da L 30 a L 120 dimensioni mm L 200 H 18
Handle titanium (opt.962T) finish
door W 15 dimensions W 100 H 18 mm
door from W 30 to W 120 dimensions W 200 H 18 mm



A RICHIESTA ON REQUEST

Maniglia finitura silver dark (opz.962S)
anta L 15 dimensioni mm L 100 H 18
anta da L 30 a L 120 dimensioni mm L 200 H 18
Handle dark silver (opt.962S) finish
door W 15 dimensions W 100 H 18 mm
door from W 30 to W 120 dimensions W 200 H 18 mm



Maniglia finitura rosso persia (opz.962P)
anta L 15 dimensioni mm L 100 H 18
anta da L 30 a L 120 dimensioni mm L 200 H 18
Handle persia red (opt.962P) finish
door W 15 dimensions W 100 H 18 mm
door from W 30 to W 120 dimensions W 200 H 18 mm



Maniglia finitura nero (opz.962N)
anta L 15 dimensioni mm L 100 H 18
anta da L 30 a L 120 dimensioni mm L 200 H 18
Handle black (opt.962N) finish
door W 15 dimensions W 100 H 18 mm
door from W 30 to W 120 dimensions W 200 H 18 mm



Maniglia finitura azzurro nube (opz.962Z)
anta L 15 dimensioni mm L 100 H 18
anta da L 30 a L 120 dimensioni mm L 200 H 18
Handle cloud blue (opt.962Z) finish
door W 15 dimensions W 100 H 18 mm
door from W 30 to W 120 dimensions W 200 H 18 mm



MANIGLIE HANDLES

Maniglia pensile
Handle wall unit

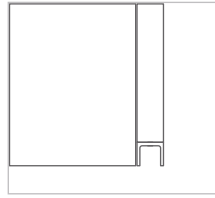

Maniglia base
Handle base unit

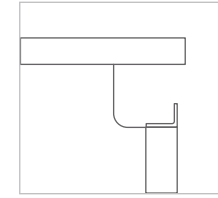

Finitura disponibile di serie:
Available finish standard



titanio ossidato (opt.PLUT)
titanium oxidized (opt.PLUT)

Finiture disponibili a richiesta
Available finishes on request



rosso persia (opt.PLUP)
persia red (opt.PLUP)



azzurro nube (opt.PLUZ)
cloud blue (opt.PLUZ)



nero (opt.PLUN)
black (opt.PLUN)

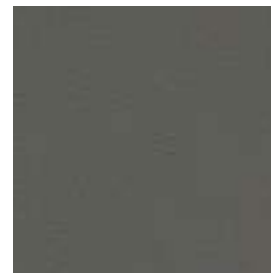

silver dark (opt.PLUS)
dark silver (opt.PLUS)

maniglia pensile
handle wall unit

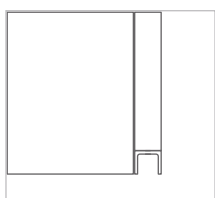

per anta L 15
per anta L 30
per angolo a libro
per anta L 40
per anta L 45
per anta L 60
per anta L 65
per anta L 75
per anta L 76
per anta L 90
per anta L 91
per anta L 120
per angolare

maniglia base
handle base unit

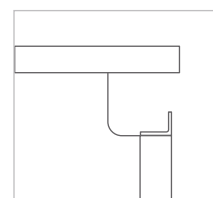

per anta L 15
per anta L 30
per anta L 40
per anta L 45
per anta L 60
per anta L 65
per anta L 75
per anta L 90
per anta L 120
per angolare

MANIGLIE HANDLES

Maniglia pensile
Handle wall unit

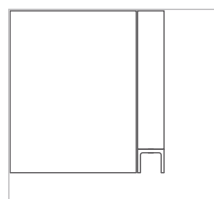

Maniglia base
Handle base unit

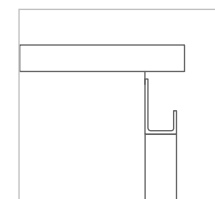

Maniglie colonna 2 ante
Column handles 2 doors

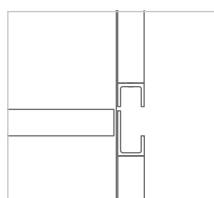

Maniglia colonna anta unica
Column handle with single door

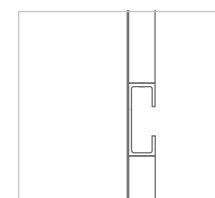

Finitura disponibile di serie:
Available finish standard



titanio ossidato (opz.UHT)
titanium oxidized (opt.UHT)

Finiture disponibili a richiesta
Available finishes on request



rosso persia (opz.UHP)
persia red (opt.UHP)



azzurro nube (opz.UHZ)
cloud blue (opt.UHZ)



nero (opz.UHN)
black (opt.UHN)



silver dark (opz.UHS)
dark silver (opt.UHS)

maniglia pensile
handle wall unit

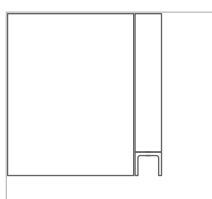

per anta L 15
per anta L 30
per angolo a libro
per anta L 40
per anta L 45
per anta L 60
per anta L 65
per anta L 75
per anta L 76
per anta L 90
per anta L 91
per anta L 120
per angolare

maniglia base
handle base unit

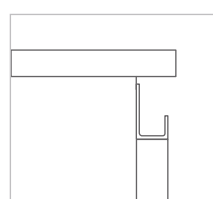

per anta L 15
per anta L 30
per anta L 40
per anta L 45
per anta L 60
per anta L 65
per anta L 75
per anta L 76
per anta L 90
per anta L 120
per angolare

maniglia colonna anta unica
column handle with single door

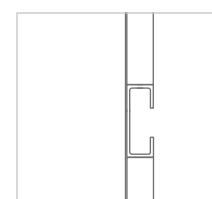

per anta L 30
per anta L 45
per anta L 60
per anta L 75

SCHIENA EFFETTO MARMO BACK PANEL MARBLE EFFECT

PENSILI

WALL UNITS

H 36-48 L 45
L 60
L 90

H 60 L 60

H 72 L 45
L 60
L 90

H 96 L 45
L 60
L 90

H 108 L 45
L 60
L 90

H 120 L 45

BASI

BASE UNITS

H 72 L 45
L 60
L 90

H 75 L 45
L 60
L 90

COLONNE

COLUMNS

H 132 L 45
L 60
L 90

H 204 L 45
L 60
L 90

COLORI SCHIENA BACK PANEL COLOUR

N.B.: solo per elementi a vetro Note: only for glass elements



perlato finitura ker (opz.3443)
pearly with ker finish



alabastro finitura mn (opz.6014)
alabaster with mn finish



calacatta finitura mn (opz.6019)
calacatta with mn finish



dark finitura mn (opz.6133)
dark with mn finish

strutture carcasses



bianco (opz.001)
schiena e ripiano bianco
(opz.001)
white (opt.001)
white back panel and shelf
(opt.001)



visone (opz.948M)
schiena e ripiano visone
(opz.948M)
mink (opt.948M)
mink back panel and shelf
(opt.948M)



lavagna (opz.9620)
schiena e ripiano lavagna
(opz.9620)
slate grey (opt.9620)
slate grey back panel
and shelf (opt.9620)



fango (opz.8860)
schiena e ripiano fango
(opz.8860)
mud (opt.8860)
mud back panel and shelf
(opt.8860)



conchiglia (opz.8910)
schiena e ripiano conchiglia
(opz.8910)
shell (opt.8910)
shell back panel and shelf
(opt.8910)



argilla (opz.9690)
schiena e ripiano argilla
(opz.9690)
clay (opt.9690)
clay back panel and shelf
(opt.9690)



lino effetto tela (opz.8920)
schiena e ripiano conchiglia
(opz.8910)
linen melamine-coated canvas
effect (opt.8920)
shell back panel and shelf (opt.8910)

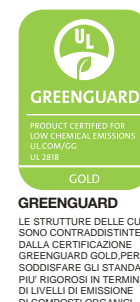

mensole in laminato P 31-61 come strutture same colours as carcasses laminate shelves D 31-61



bianco (opz.001)
white (opt.001)



visone (opz.948M)
mink (opt.948M)



lavagna (opz.9620)
slate grey (opt.9620)



conchiglia (opz.8910)
shell (opt.8910)



argilla (opz.9690)
clay (opt.9690)



fango (opz.8860)
mud (opt.8860)

mensole melaminico melamine shelves



melaminico come ante
N.B.: per le finiture vedi pagine 12-13
melamine same finish as doors
Note: for the finishes see pages 12-13

zoccoli in pvc H 13 pvc plinths H 13

di serie
standard



acciaio (opz.407)
steel (opt.407)



alluminio satinato
(opz.405)
satin aluminium
(opt.405)



bianco (opz.001)
white (opt.001)

zoccoli in alluminio H 13 aluminium plinths H 13



alluminio
finitura brill (opz.412)
aluminium
brill finish (opt.412)



alluminio finitura titanio
ossidato (opz.414)
aluminium titanium
oxidized finish (opt.414)

zoccoli in alluminio H 13 verniciati a polvere finitura opaca aluminium plinths H 13 powder coated matt finish

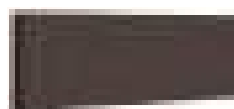

alluminio finitura
ghisa (opz.9509)
aluminium cast iron
finish (opt.9509)



alluminio finitura
fumo (opz.9531)
aluminium
smoke finish (opt.9531)



alluminio finitura
silver dark (opz.9507)
aluminium dark silver
finish (opt.9507)



alluminio finitura
bianco assoluto (opz.740S)
aluminium absolute
white finish (opt.740S)



alluminio grigio
traffico (opz.9511)
aluminium traffic grey
finish (opt.9511)



alluminio finitura
conchiglia (opz.7403)
aluminium shell
finish (opt.7403)



alluminio finitura
argilla (opz.9503)
aluminium clay
finish (opt.9503)



alluminio finitura rosso
persia (opz.8165)
aluminium persia red
finish (opt.8165)



alluminio lino
(opz.W770)
aluminium linen
(opt.W770)



alluminio finitura
grigio selce (opz.SE)
aluminium flint grey
finish (opt.SE)



alluminio finitura
azzurro nube
(opz.8379)
aluminium cloud blue
finish (opt.8379)



alluminio finitura grigio
kenia (opz.9501)
aluminium kenia grey
finish (opt.9501)

MODULARITÀ E COMPONIBILITÀ MODULARITY AND FITTING SOLUTIONS

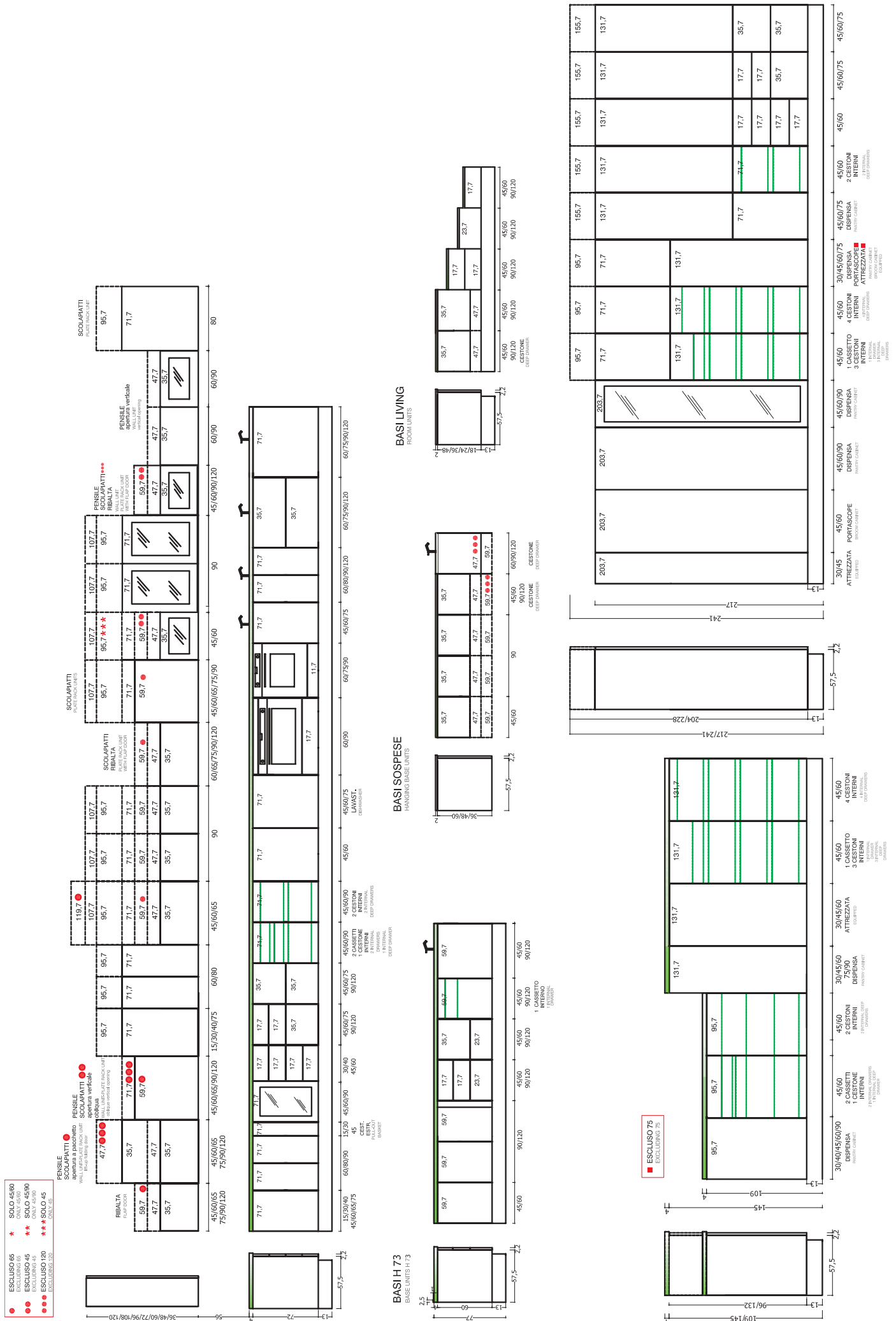

APERTURA A RIBALTA

Le ante aprendosi verso l'alto consentono di avere un' ampia visione d'insieme all'interno del mobile.

La regolazione della forza di apertura può essere impostata in modo esatto in base al peso del frontale. Grazie all'arresto progressivo le ante si fermano in qualsiasi posizione; in questo modo la maniglia è sempre facilmente raggiungibile. La chiusura è ammortizzata e un'unica manovra è sufficiente per regolare il frontale tridimensionalmente grazie all'assenza di cerniere e al sistema di aggancio clip.

WALL UNIT WITH FLAP DOOR

The doors that open upwards guarantee ample overall visibility inside the cabinet.

The opening force can be adjusted precisely according to the weight of the front. The doors stop in any position thanks to the gradual stopping movement; in this way, the handle is always easily accessible. The closing movement is cushioned and a single manoeuvre is required to three-dimensionally adjust the front, thanks to the clip-on system and the absence of hinges.



DI SERIE
STANDARD



MOTORIZZATO
SERVO-DRIVE
SERVO-DRIVE
MOTORISED
(Opz.007)



	A	B	C
H 36	11,5	3,5	37
H 48	15	3,5	49
H 60	18,5	3,5	61

Per evitare l'interferenza dell'anta in fase di apertura con cornici o mensole, si può richiedere il limitatore dell'angolo di apertura cod. 5620010

In order to avoid that the door interferes with cornices or shelves during the opening movement, it is possible to request an opening angle limiter: code 5620010

SCHEMA MONTAGGIO LIMITATORE PER RIBALTA H 36
FLAP DOOR LIMITER INSTALLATION DIAGRAM H 36

SCHEMA MONTAGGIO LIMITATORE PER RIBALTA H 48
FLAP DOOR LIMITER INSTALLATION DIAGRAM H 48

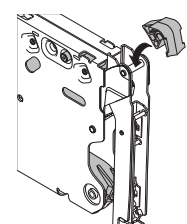
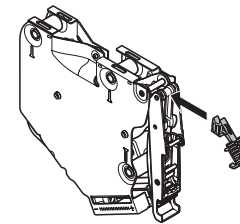

APERTURA VERTICALE OBLIQUA

I pensili con questo tipo di meccanismo necessitano per l'apertura di poco spazio libero sopra il mobile grazie al movimento basculante dell'anta che si apre senza difficoltà applicando poca forza anche in presenza di frontali pesanti. Con l'arresto progressivo le ante si fermano in qualsiasi posizione; in questo modo la maniglia è sempre facilmente raggiungibile. La chiusura è ammortizzata ed è possibile regolare la forza di tenuta in base al peso del frontale.

VERTICAL OPENING OBLIQUE

Wall units that mount this type of mechanism require little clearance above the cabinet thanks to the swivelling movement of the door that can be easily opened by applying slight pressure, even with heavy fronts. The doors stop in any position thanks to the gradual stopping movement; in this way, the handle is always easily accessible. The closing movement is cushioned and the closing force can be adjusted according to the weight of the front door.



DI SERIE
STANDARD



MOTORIZZATO
SERVO-DRIVE
SERVO-DRIVE
MOTORISED
(Opz.007)

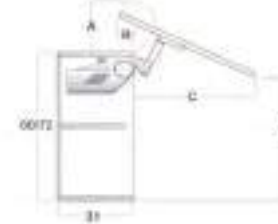

	A	B	C	D
H 60	18	9,6	46,5	53,5
H 72	18	9,6	57	61

APERTURA VERTICALE

L'anta ad apertura verticale, potendo essere sollevata completamente verso l'alto, consente un accesso totale all'interno del pensile. Ideale per l'impiego in mobili a colonna per nascondere ad esempio apparecchi elettrici, o pensili con corpi mobili sovrastanti, ha la chiusura ammortizzata e la possibilità di regolare la forza di tenuta in base al peso del frontale.

VERTICAL OPENING

Doors with vertical opening movement can be fully raised to fully access the inside of the wall unit.

Ideal for use on column units to conceal electrical appliances for examples, or on wall units surmounted by mobile units.

The closing movement is cushioned and the closing force can be adjusted according to the weight of the front door.



**DI SERIE
STANDARD**



**MOTORIZZATO
SERVO-DRIVE**
SERVO-DRIVE
MOTORISED
(Opz.007)

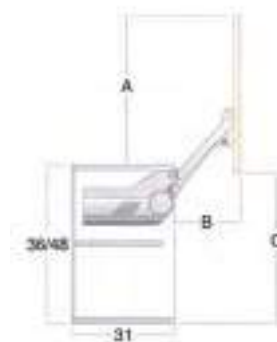

	A	B	C	
H 36	34	23,5	34,5	
H 48	43	28,5	43,5	

APERTURA ANTE A PACCHETTO

Il meccanismo d'apertura ante a pacchetto è idoneo sul pensile H 72; la regolazione della forza di apertura può essere impostata in modo esatto in base ai pesi dei frontali, la chiusura è ammortizzata e la cerniera centrale clip si contraddistingue per l'innovativa tecnologia che garantisce la sicurezza per le dita.

LIFT-UP FOLDING DOORS

The lift-up folding door opening mechanism is suitable for wall units with H 72; the opening force can be adjusted precisely according to the weight of the fronts, while the closing movement is cushioned and the central clip-on hinge features innovative technology for safeguarding the fingers.



**DI SERIE
STANDARD**



**MOTORIZZATO
SERVO-DRIVE**
SERVO-DRIVE
MOTORISED
(Opz.007)



	A	B	C	
H 72	16,5	54	41	
H 96	20	69	53	

**SCHEMA MONTAGGIO
LIMITATORE**
LIMITER INSTALLATION
DIAGRAM

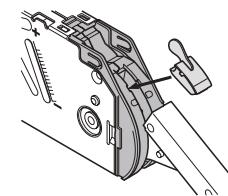

Per evitare l'interferenza dell'anta in fase di apertura con cornici o mensole, si può richiedere il limitatore dell'angolo di apertura cod. 5620005

In order to avoid that the door interferes with cornices or shelves during the opening movement, it is possible to request an opening angle limiter: code 5620005

COLONNE ARMADIO “NOOK” H 217 P 70,4 CON ANTE A SCOMPARSA

“NOOK” CLOSET COLUMNS H 217 D 70,4 WITH DOORS INWARDS

Le colonne armadio “Nook” con ante a scomparsa, consentono di inserire all’interno forno, frigo, tavolo e cassetti

“Nook” closet columns with pull-out doors allow to insert oven, fridge, table and drawer on the inside



COLONNE ARMADIO “NOOK” H 217 P 70,4 CON ANTE A SCOMPARSA

“NOOK” CLOSET COLUMNS H 217 D 70,4 WITH DOORS INWARDS









Il tavolo estraibile è disponibile nella versione inox o in laminato, nella finitura oak cognac

The pull-out table it's available in stainless steel version or laminate oak cognac finish

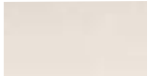

MENSOLE

SHELVES

	COD.			COD.		
<p>mensola sp. 3,8 in nobilitato colori strutture L max cm 400 melamine shelf Th. 3.8, colours carcasses max. length 400 cm</p>  <p>Colori strutture Structure colours</p> <div style="display: flex; justify-content: space-around;"> <div style="text-align: center;">  bianco (opz.001) white </div> <div style="text-align: center;">  visone (opz.948M) mink </div> <div style="text-align: center;">  argilla (opz.9690) clay </div> </div> <div style="display: flex; justify-content: space-around; margin-top: 10px;"> <div style="text-align: center;">  lavagna (opz.9620) slate grey </div> <div style="text-align: center;">  fango (opz.8860) mud </div> <div style="text-align: center;">  conchiglia (opz.8910) shell </div> </div>						
					08610400	
		091523				
	091560					
<p>reggimensola a scomparsa fully integrated shelf bracket</p> 						
<p>mensola sp. 3,8 in melaminico, L max cm 275 finiture come ante vedi pag.12-13 melamine shelf Th. 3.8, max. length 275 cm same finishes as doors see page.12-13</p> 						
		091523				
	091560					

CABINA RIPOSTIGLIO

CLOSET COLUMN



COLORI ANTE CHIUSE E PANNELLI FISSI FRONTALE E LATERALE COLOURS FOR DOORS AND FIXED FRONT LATERAL PANELS



MELAMINICO per colori vedi pag.12-13
MELAMINE for colours see page 12-13

ANTE VETRO GLASS DOORS

N.B.: per colori vedi pag. 14-15
NOTE: for colours see pages 14-15



telaio grigio selce
con vetro trasparente
(opz.UNGT)
flint grey frame with
transparent glass
(opt.UNGT)

telaio grigio selce
con vetro satinato
(opz.UNGS)
flint grey frame with
satin glass (opt.UNGS)

telaio grigio selce
con vetro bronzo satinato
(opz.UNGB)
flint grey frame with
satin bronze glass
(opt.UNGB)

telaio silver dark
con vetro trasparente
(opz.UNST)
dark silver frame with
transparent glass
(opt.UNST)

telaio silver dark
con vetro satinato
(opz.UNSS)
dark silver frame with
satin glass
(opt.UNSS)

telaio silver dark
con vetro fumè satinato
(opz.UNSF)
dark silver frame with
smoked satin glass
(opt.UNSF)



telaio nero
con vetro trasparente
(opz.UNNT)
black frame with
transparent glass
(opt.UNNT)

telaio nero
con vetro satinato
(opz.UNNS)
black frame with
satin glass
(opt.UNNS)

telaio nero
con vetro fumè satinato
(opz.UNNF)
black frame with
smoked satin glass
(opt.UNNF)

COLORI STRUTTURA INTERNA IN NOBILITATO COLOURS FOR INTERNAL MELAMINE-COATED STRUCTURE

bianco (opz.001) white	visone (opz.948M) mink	lavagna (opz.9620) slate grey	fango (opz.8860) mud	conchiglia (opz.8910) shell	argilla (opz.9690) clay
lino effetto tela (opz.8920) linen melamin-coated canvas					

MOBILI "BREAK" CON VASCHETTA IN METALLO

"BREAK" FURNITURE WITH METAL TRAY



COLORI VASCHETTA TRAY COLOURS

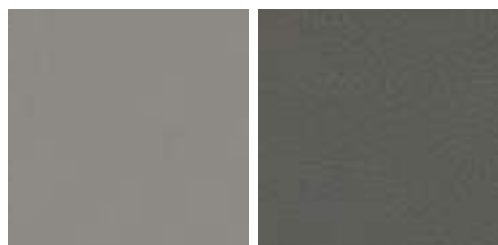

grigio selce (opz.95SE) silver dark (opz.9507)
flint grey dark silver

COLORI STRUTTURE E ANTE IN MELAMINICO CARCASS AND DOORS MELAMINE COLOURS



phagos nuvola finitura chiselled (opz.1567) chiselled finish cloud phagos
 phagos bianco finitura chiselled (opz.1566) chiselled finish white phagos
 phagos kapok finitura chiselled (opz.1560) chiselled finish kapok phagos
 phagos vulcano finitura chiselled (opz.1568) chiselled finish vulcano phagos
 perla finitura rovere naturale (opz.5314) pearl natural oak finish
 platino finitura effetto ossidato (opz.9661) platinum oxidized effect finish
 pietra grey finitura materica (opz.9642) grey stone textured finish

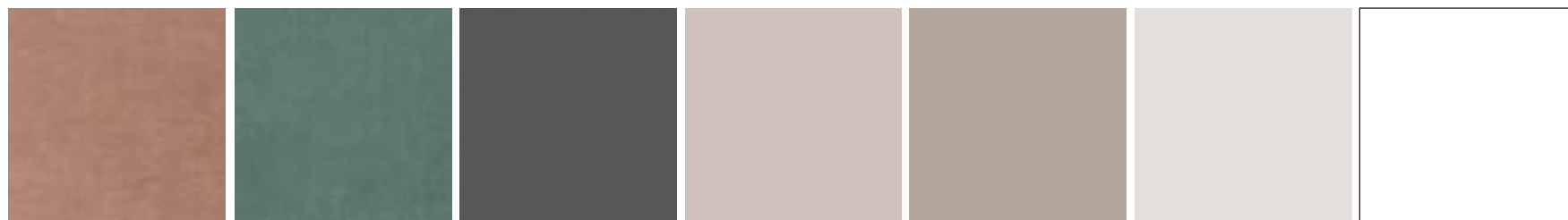

pietra fulvus finitura materica (opz.8867) fulvus stone textured finish
 pietra musk finitura materica (opz.8403) musk stone textured finish
 antracite finitura seta tinta unita (opz.9643) anthracite solid color silk finish
 dove grey finitura seta tinta unita (opz.8971) grey dove solid color silk finish
 ecru finitura seta tinta unita (opz.9641) ecru solid color silk finish
 grigio chiaro finitura seta tinta unita (opz.9640) clear grey solid color silk finish
 bianco assoluto finitura seta tinta unita (opz.7450) absolute white solid color silk finish

MOBILI A GIORNO SP. 18 MM

OPEN FORNITURE TH.18 MM



COLORI MELAMINICI MELAMINE COLOURS



phagos nuvola finitura
chiselled (opz.1567)
chiselled finish cloud
phagos

phagos bianco finitura
chiselled (opz.1566)
chiselled finish white
phagos

phagos kapok finitura
chiselled (opz.1560)
chiselled finish kapok
phagos

phagos vulcano finitura
chiselled (opz.1568)
chiselled finish
volcano phagos

perla finitura rovere
naturale (opz.5314)
pearl natural oak
finish

platino finitura effetto
ossidato (opz.9661)
platinum oxidized
effect finish

pietra grey finitura
materica (opz.9642)
grey stone textured
finish

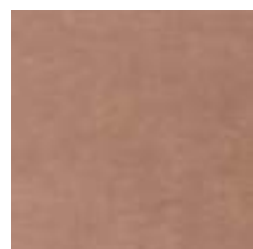

pietra fulvus finitura
materica (opz.8867)
fulvus stone textured
finish

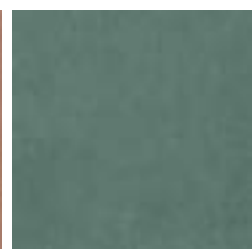

pietra musk finitura
materica (opz.8403)
musk stone textured
finish

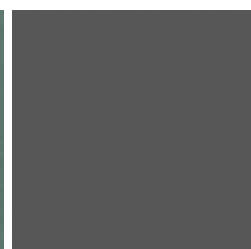

antracite finitura seta
tinta unita (opz.9643)
anthracite solid color
silk finish



dove grey finitura seta
tinta unita (opz.8971)
grey dove solid color
silk finish

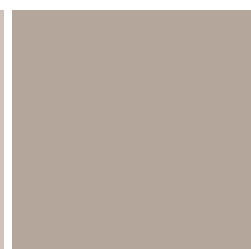

ecru finitura seta
tinta unita (opz.9641)
ecru solid color
silk finish

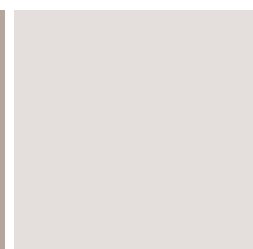

grigio chiaro finitura
seta tinta unita
(opz.9640)
clear grey solid color
silk finish



bianco assoluto finitura
seta tinta unita (opz.7450)
absolute white solid color
silk finish



ELEMENTI A GIORNO “UNI-CODE”

“UNI-CODE” OPEN UNITS



COLORI MONTANTI IN METALLO COLOURS METAL ELEMENTS

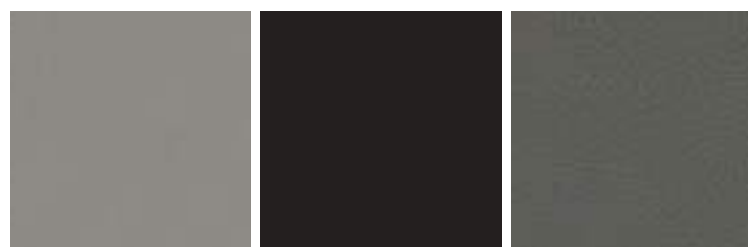

grigio selce (opz.95SE)
flint grey

nero (opz.7892)
black

silver dark (opz.9507)
dark silver

COLORI MENSOLE MELAMINICO SHELVES MELAMINE COLOURS

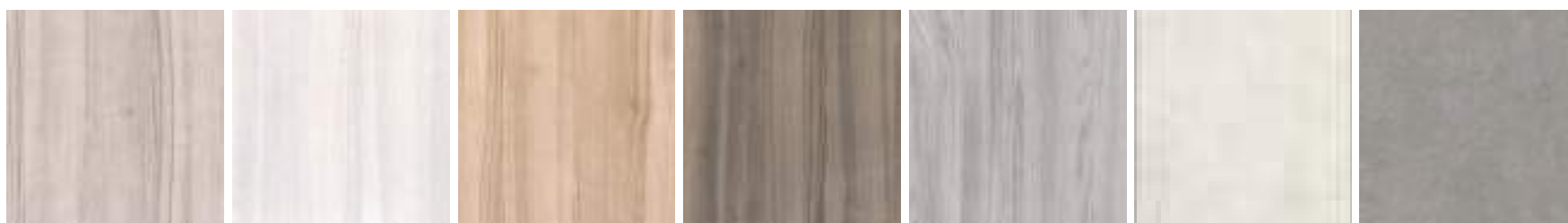

phagos nuvola finitura
chiselled (opz.1567)
chiselled finish cloud
phagos

phagos bianco finitura
chiselled (opz.1566)
chiselled finish white
phagos

phagos kapok finitura
chiselled (opz.1560)
chiselled finish kapok
phagos

phagos vulcano finitura
chiselled (opz.1568)
chiselled finish
volcano phagos

perla finitura rovere
naturale (opz.5314)
pearl natural oak
finish

platino finitura effetto
ossidato (opz.9661)
platinum oxidized
effect finish

pietra grey finitura
materica (opz.9642)
grey stone textured
finish

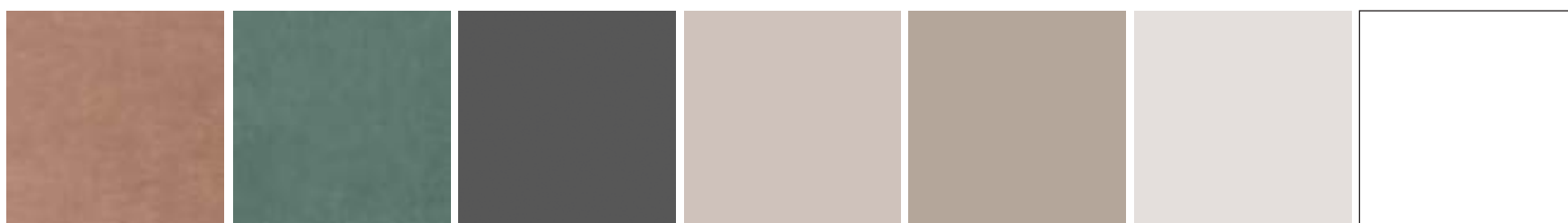

pietra fulvus finitura
materica (opz.8867)
fulvus stone textured
finish

pietra musk finitura
materica (opz.8403)
musk stone textured
finish

antracite finitura seta
tinta unita (opz.9643)
anthracite solid color
silk finish

dove grey finitura seta
tinta unita (opz.8971)
grey dove solid color
silk finish

ecru finitura seta
tinta unita (opz.9641)
ecru solid color
silk finish

grigio chiaro finitura
seta tinta unita
(opz.9640)
clear grey solid color
silk finish

bianco assoluto finitura
seta tinta unita (opz.7450)
absolute white solid color
silk finish



VIVI IL LIVING

LIVE THE LIVING

Con i nuovi pensili più profondi
è facilissimo creare composizioni living
adatte ad ogni spazio.

With new more deep wall units,
it's easy to create lively
furnishing compositions.



LIVING UN01



ANTE
doors

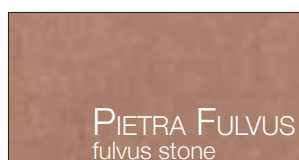

ELEMENTI A GIORNO
open units



ANTA VETRO
TELAIO GRIGIO SELCE
VETRO SATINATO
glass doors
flint grey frame
satin glass

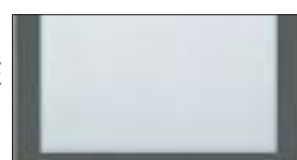

STRUTTURE
carcasses



LIVING UN01

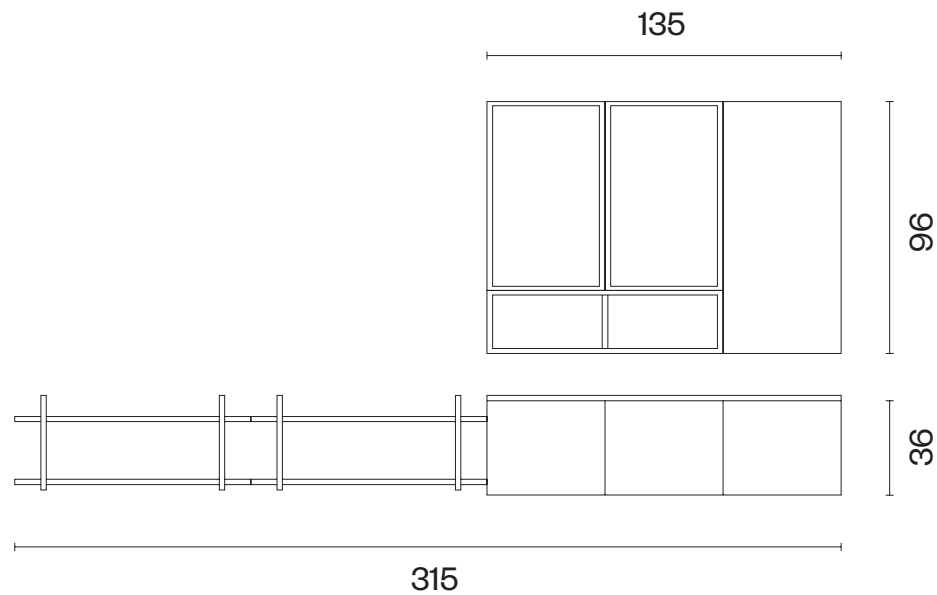

NR. ELEMENTI	DESCRIZIONE	CODICE
2	Pensile L 45 H 72 P 33,4 anta vetro apertura push pull, ripiano vetro	G1012451/2
2	Luce "VIVARA 8" L&S L 45 per ripiano vetro	08618353
1	Cavo alimentazione MC DRIVER L&S	08618020
1	Trasformatore MC DRIVER L&S	08618000
1	Distributore L&S	08618025
1	Pensile L 45 H 96 P 33,4 apertura push pull	E2020451/2
1	Elemento a giorno L 90 H 24 2 vani in melaminico come anta	E77U0004
2	Base living sospesa L 45 H 36 P 50,4 cestone apertura tip-on, fianco come anta	EBL75450
1	Base living sospesa L 45 H 36 P 50,4 cestone apertura tip-on	EBL75450
2	Elemento "UNICODE" L 90 H 36	ECODEU03609 328
1	Top living L 135 H 2,2 P 50,4 in melaminico come anta	al ml TLE225
1	Asta appendipensili ml 2	08610501

No. of ELEMENTS	DESCRIPTION	CODE
2	Wall unit W 45 H 72 D 33,4 glass door, push-pull opening with glass shelf	G1012451/2
2	Light "VIVARA 8" L&S W 45 for glass shelf	08618353
1	Power cable MC DRIVER L&S	08618020
1	Power supply module MC DRIVER L&S	08618000
1	Distributor module L&S	08618025
1	Wall unit W 45 H 96 D 33,4 push-pull opening	E2020451/2
1	Melamine open unit W 90 H 24 same colours as door 2 compartments	E77U0004
2	Hanging living base unit W 45 H 36 D 50,4 deep drawer tip-on opening, side same as door	EBL75450
1	Hanging living base unit W 45 H 36 D 50,4 deep drawer tip-on opening	EBL75450
2	"UNICODE" unit L 90 H 36	ECODEU03609 328
1	Melamine living worktop W 135 H 2,2 D 50,4 same as door	per lm TLE225
1	Wall unit fixing strip lm 2	08610501

LIVING UN02



ANTA
door



ELEMENTI A GIORNO
open units

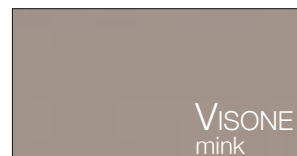

STRUTTURA
carcass



ANTA VETRO
TELAIO SILVER DARK
VETRO TRASPARENTE
glass doors
dark silver frame
trasparent glass

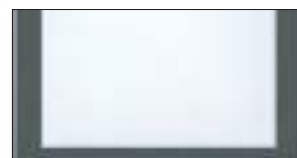

LIVING UN02

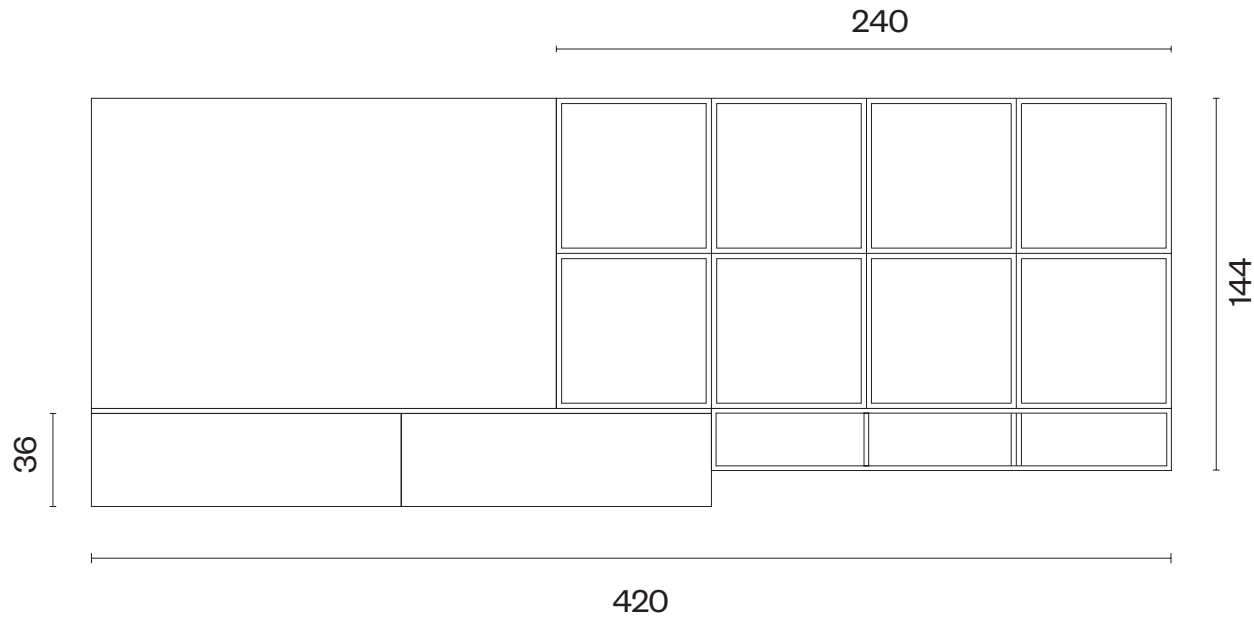

NR. ELEMENTI	DESCRIZIONE	CODICE
8	Pensile vetro L 60 H 60 P 33,4 telaio alluminio, apertura push-pull e ripiano vetro	G1062601/2
8	Luce "VIVARA 8" L&S L 60 per ripiano vetro	08618354
1	Cavo alimentazione MC DRIVER L&S	08618020
1	Trasformatore MC DRIVER L&S	08618003
1	Distributore L&S	08618025
1	Elemento a giorno L 120 H 24 2 vani in melaminico come anta	E77U0004
1	Elemento a giorno L 60 H 24 in melaminico come anta	E77U0002
2	Base living sospesa L 120 H 36 P 50,4 cestone apertura tip-on, fianco come anta	EBL76200
1	Top living L 240 H 2,2 P 50,4 in melaminico come anta	al ml TLE225
1	Schienale L 180 H 96 SP. 2,2 in melaminico come anta	al mq 094511
4	Asta appendipensili ml 2	08610501

No. of ELEMENTS	DESCRIPTION	CODE
8	Glass wall unit W 60 H 60 D 33,4 aluminum frame push-pull opening with glass shelf	G1062601/2
8	Light "VIVARA 8" L&S W 60 for glass shelf	08618354
1	Power cable MC DRIVER L&S	08618020
1	Power supply module MC DRIVER L&S	08618003
1	Distributor module L&S	08618025
1	Melamine open unit W 120 H 24 same colors as door 2 compartments	E77U0004
1	Melamine open unit W 60 H 24 same colors as door	E77U0002
2	Hanging living base unit W 120 H 36 D 50,4 deep drawer tip-on opening, side same as door	EBL76200
1	Melamine living worktop W 240 H 2,2 D 50,4 same as door	per lm TLE225
1	Melamine back panel W 180 H 96 TH. 2,2 same as door	per m ² 094511
4	Wall unit fixing strip lm 2	08610501

LIVING UN03



ANTA
door



MENSOLA KOMPO
KOMPO SHELF



STRUTTURA
carcass

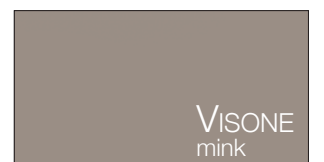

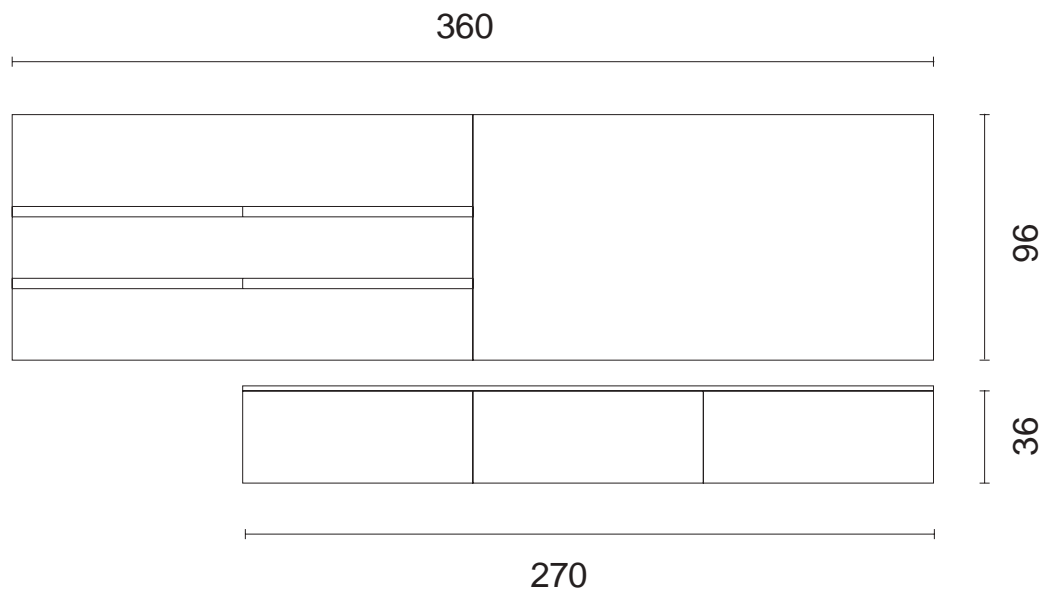

NR. ELEMENTI	DESCRIZIONE	CODICE
2	Base living sospesa L 90 H 36 P 50,4 cestone apertura tip-on, fianco come anta	EBL75900
1	Base living sospesa L 90 H 36 P 50,4 cestone apertura tip-on	EBL75900
1	Top living L 270 H 2,2 P 50,4 in melaminico come anta	al ml TLE225
4	Mensola Kompo in lamiera verniciata L 90 H 63 P 33,6 con luce	03993722
2	Schienale L 180 H 96 SP. 2,2 in melaminico come anta	al mq 094511
TOTALE		
No. of ELEMENTS	DESCRIPTION	CODE
2	Hanging living base unit W 90 H 36 D 50,4 deep drawer tip-on opening, side same as door	EBL75900
1	Hanging living base unit W 90 H 36 D 50,4 deep drawer tip-on opening	EBL75900
1	Melamine living worktop W 270 H 2,2 D 50,4 same as door	per lm TLE225
4	Painted sheet shelf Kompo W 90 H 63 D 33,6 with light	03993722
2	Melamine back panel W 180 H 96 TH. 2,2 same as door	per m ² 094511
TOTAL		

LIVING UN04



ANTE
doors



ELEMENTI A GIORNO
open units



ANTA VETRO
TELAIO SILVER DARK
VETRO FUMÈ SATINATO
glass doors
dark silver frame
smoked satin glass

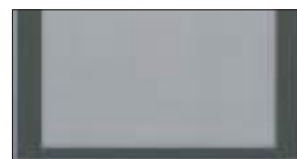

STRUTTURA
carcass



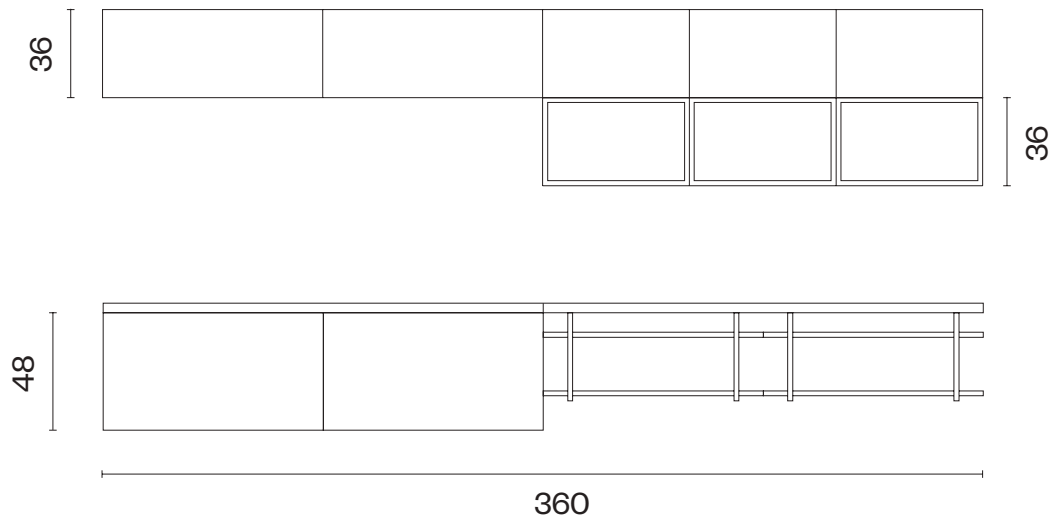

NR. ELEMENTI	DESCRIZIONE	CODICE
1	Pensile L 90 H 36 P 33,4 apertura tip-on, fianco come anta	E210090T
1	Pensile L 90 H 36 P 33,4 apertura tip-on	E210090T
2	Pensile L 60 H 36 P 33,4 apertura tip-on	E210060T
1	Pensile L 60 H 36 P 33,4 apertura tip-on, fianco come anta	E210060T
3	Pensile vetro L 60 H 36 P 33,4 telaio alluminio, apertura tip-on	G110260T
2	Pensile L 90 H 48 P 33,4 apertura winch, fianco come anta	E2123900
2	Elemento "UNICODE" L 90 H 36 P 31	ECODEU03609
2	Mensola L 180 H 4 P 33,4 in melaminico come anta	al ml 091527
4	Asta appendipensili ml 2	08610501

No. of ELEMENTS	DESCRIPTION	CODE
1	Wall unit W 90 H 36 D 33,4 tip-on opening side same as door	E210090T
1	Wall unit W 90 H 36 D 33,4 tip-on opening	E210090T
2	Wall unit W 60 H 36 D 33,4 tip-on opening	E210060T
1	Wall unit W 60 H 36 D 33,4 tip-on opening side same as door	E210060T
3	Glass wall unit W 60 H 36 D 33,4 aluminum frame tip-on opening	G110260T
2	Wall unit W 90 H 48 D 33,4 winch opening side same as door	E2123900
2	"UNICODE" unit L 90 H 36 D 31	ECODEU03609
2	Melamine shelf W 180 H 4 D 33,4 same as door	per lm 091527
4	Wall unit fixing strip lm 2	08610501

LIVING UN05



ANTE
doors



ECRU
ecru

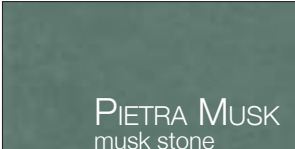

PIETRA MUSK
musk stone

ELEMENTI A GIORNO
open units



ECRU
ecru

MENSOLA KOMPO
KOMPO SHELF



ECRU
ecru

STRUTTURE
carcasses



VISONE
mink

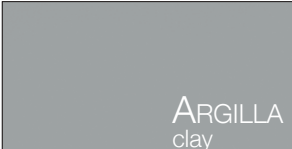

ARGILLA
clay

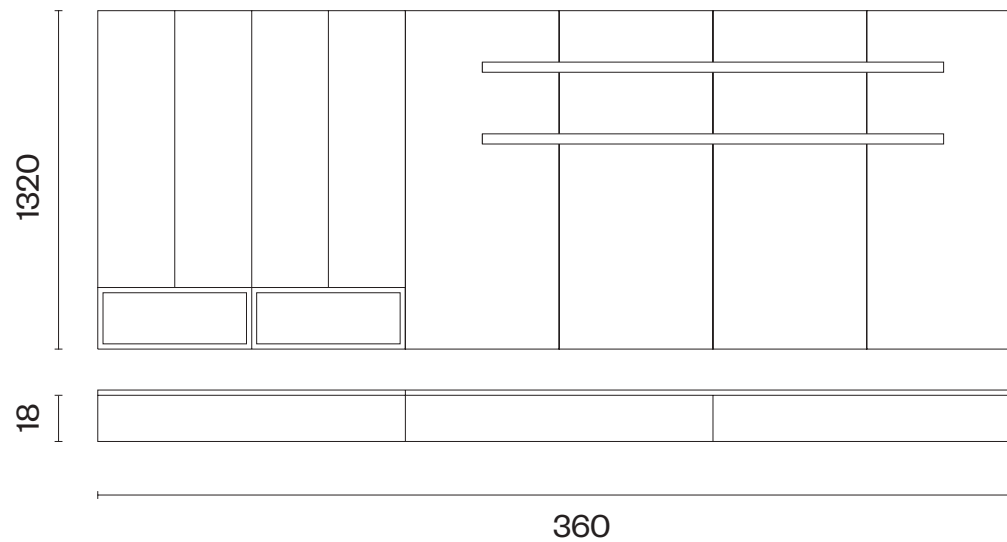

NR. ELEMENTI	DESCRIZIONE	CODICE
2	Pensile L 30 H 120 P 33,4 apertura push pull, fianco come anta	E2145301/2
2	Pensile L 30 H 120 P 33,4 apertura push pull	E2145301/2
1	Elemento a giorno L 120 H 24 P 31 in melaminico come anta	E77U0004
2	Base living L 120 H 18 P 50,4 cassetto apertura tip-on, fianco come anta	EBL04200
1	Base living L 120 H 18 P 50,4 cassetto apertura tip-on	EBL04200
4	Schienale L 60 H 132 SP. 2,2 in melaminico come anta	al mq 094511
4	Mensola Kompo in lamiera verniciata L 90 H 63 P 33,6 con luce	03993722
1	Top living L 120 P 50,4 SP. 2,2 in melaminico come anta	al ml TLE225
1	Top living L 240 P 50,4 SP. 2,2 in melaminico come anta	al ml TLE225
1	Asta appendipensili ml 2	08610501

No. of ELEMENTS	DESCRIPTION	CODE
2	Wall unit W 30 H 120 D 33,4 push pull opening, side same as door	E2145301/2
2	Wall unit W 30 H 120 D 33,4 push pull opening	E2145301/2
1	Melamine open unit W 120 H 24 D 31 same as door	E77U0004
2	Living base unit W 120 H 18 D 50,4 drawer tip-on opening, side same as door	EBL04200
1	Living base unit W 120 H 18 D 50,4 drawer tip-on opening	EBL04200
4	Melamine back panel W 60 H 132 TH. 2,2 same as door	per m ² 094511
4	Painted sheet shelf Kompo W 90 H 63 D 33,6 with light	03993722
1	Melamine living worktop W 120 D 50,4 TH. 2,2 same as door	per lm TLE225
1	Melamine living worktop W 240 D 50,4 TH. 2,2 same as door	per lm TLM225
1	Wall unit fixing strip lm 2	08610501

LIVING UN06



ANTA
door

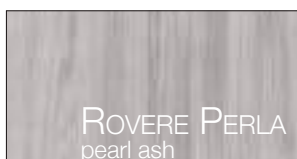

ELEMENTI A GIORNO
open units



STRUTTURA
carcass

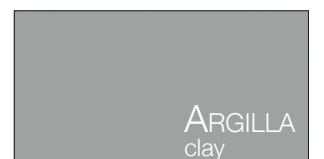

ANTA VETRO
TELAIO GRIGIO SELCE
VETRO BRONZO SATINATO
glass doors
flint grey frame
bronze satin glass

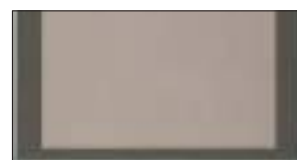

LIVING UN06

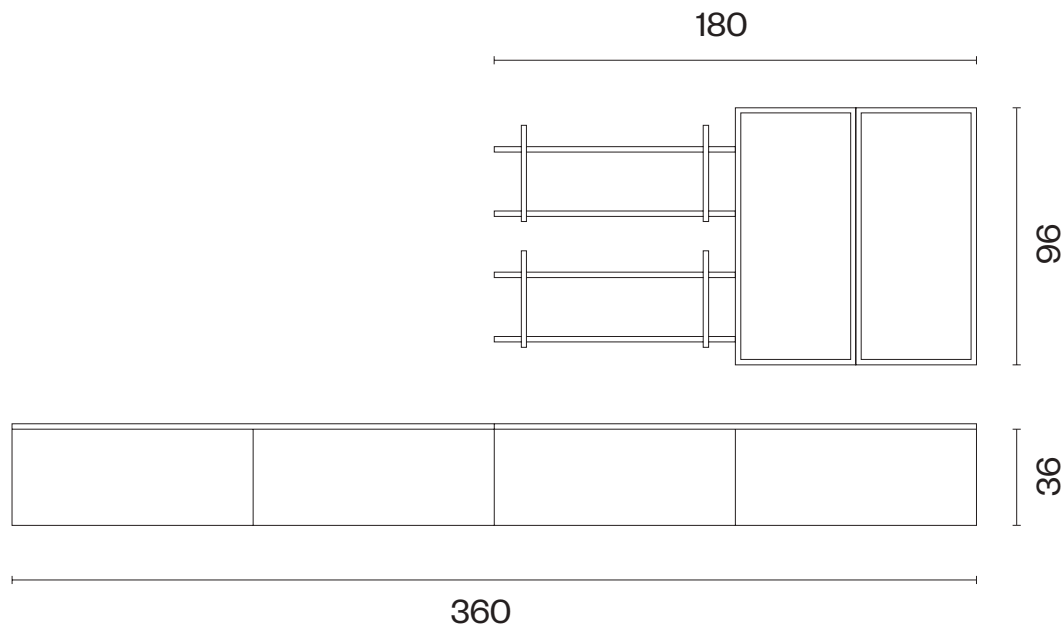

NR. ELEMENTI	DESCRIZIONE	CODICE
2	Pensile vetro L 45 H 96 P 33,4 telaio alluminio, apertura push-pull e ripiano vetro	G1022451/2
4	Luce "VIVARA 8" L&S L 45 per ripiano vetro	08618353
1	Cavo alimentazione MC DRIVER L&S	08618020
1	Trasformatore MC DRIVER L&S	08618001
1	Distributore L&S	08618025
2	Base living sospesa L 90 H 36 P 50,4 cestone apertura tip-on, fianco come anta	EBL75900
2	Base living sospesa L 90 H 36 P 50,4 cestone apertura tip-on	EBL75900
2	Top living L 180 H 2,2 P 50,4 in melaminico come anta	al ml TLE225
2	Elemento "UNICODE" L 90 H 36 P 31	ECODEU03609 328
1	Asta appendipensili ml 2	08610501
TOTALE		

No. of ELEMENTS	DESCRIPTION	CODE
2	Glass wall unit W 45 H 96 D 33,4 aluminum frame push-pull opening with glass shelves	G1022451/2
4	Light "VIVARA 8" L&S W 45 for glass shelf	08618353
1	Power cable MC DRIVER L&S	08618020
1	Power supply module MC DRIVER L&S	08618001
1	Distributor module L&S	08618025
2	Hanging living base unit W 90 H 36 D 50,4 deep drawer tip-on opening, side same as door	EBL75900
2	Hanging living base unit W 90 H 36 D 50,4 deep drawer tip-on opening	EBL75900
2	Melamine living worktop W 180 TH. 2,2 D 50,4 same as door	per lm TLE225
2	"UNICODE" unit L 90 H 36 D 31	ECODEU03609
1	Wall unit fixing strip lm 2	08610501

COMPOSIZIONE L 305

COMPOSITION W 305



COMPOSIZIONE L 423

COMPOSITION W 423



COMPOSIZIONE L 305

COMPOSITION W 305

COMPONENTI COMPONENTS

Colonna 60 H 217 frigo-freezer 230 classe A+ con gola verticale e fianco come anta

60 cm column H 217 fridge-freezer 230 class "A+" with vertical groove as doors and side

Base 60

60 cm base unit

Base 60 forno multifunzione inox

60 cm base unit for stainless steel multifunctional oven

Piano cottura 60 4 gas inox con valvola

60 cm stainless steel hob with 4 burners with safety valve

Base 60 2 cassetti e cestone

60 cm base unit with 2 drawers and deep drawer

Sottolavello 60

60 cm sink unit

Lavello ad incasso 86 x 50 1 vasca inox

86x50 cm built-in sink with 1 stainless steel bowl

Top 240 P 61 in laminato H 4

240 cm laminate worktop D 61 H 4

Pensile 60 H 72

60 cm wall unit H 72

Cappa 60 "Mod. 29" H 72

60 cm hood "Mod.29" H 72

Pensile 60 H 72

60 cm wall unit H 72

Scolapiatti 60 H 72

60 cm plate rack H 72

Asta appendipensili ml 4

4 lm wall unit fixing strip

(Elettrodomestici Hotpoint)
(Hotpoint appliances)

VERSIONI VERSIONS

LUX

fascia "A"

band "A"

fascia "B"

band "B"

NECK

fascia "A"

band "A"

fascia "B"

band "B"

con maniglia fascia "A"

with handle band "A"

con maniglia fascia "B"

with handle band "B"

COMPOSIZIONE L 423

COMPOSITION W 423

COMPONENTI COMPONENTS

Colonna 60 H 217 frigo-freezer 315 classe A+

60 cm column H 217 fridge-freezer 315 class "A+"

Colonna 60 H 217 forno multifunzione inox

60 cm column H 217 for stainless steel multifunctional oven

Base 60

60 cm base unit

Piano cottura 75 5 gas inox con valvola

75 cm stainless steel hob with 5 burners with safety valve

Base 90 2 cassetti e cestone predisposta piano cottura

90 cm base unit with 2 drawers and deep drawers configured for hob

Base 60

60 cm base unit

Sottolavello 90

90 cm sink unit

Lavello ad incasso 86 x 50 1 vasca inox

86x50 cm built-in sink with 1 stainless steel bowl

Top 300 P 61 in laminato H 4

300 cm laminate worktop D 61 H 4

Pensile 60 H 72

60 cm wall unit H 72

Cappa 90 "STILO SMART" inox

90 cm "STILO SMART" stainless steel hood

Pensile 60 H 72

60 cm wall unit H 72

Scolapiatti 90 H 72

90 cm plate rack H 72

Asta appendipensili ml 4

4 lm wall unit fixing strip

(Elettrodomestici Hotpoint)
(Hotpoint appliances)

VERSIONI VERSIONS

LUX

fascia "A"

band "A"

fascia "B"

band "B"

NECK

fascia "A"

band "A"

fascia "B"

band "B"

con maniglia fascia "A"

with handle band "A"

con maniglia fascia "B"

with handle band "B"

COMPOSIZIONE L 300

COMPOSITION W 300



COMPOSIZIONE L 420

COMPOSITION W 420



COMPOSIZIONE L 300

COMPOSITION W 300

COMPONENTI COMPONENTS

Colonna 60 H 217 frigo-freezer 230 classe A+

60 cm column H 217 fridge-freezer 230 class "A+"

Base 60

60 cm base unit

Base 60 forno multifunzione inox

60 cm base unit for stainless steel multifunctional oven

Piano cottura 60 4 gas inox con valvola

60 cm stainless steel hob with 4 burners with safety valve

Base 60 2 cassetti e cestone

60 cm base unit with 2 drawers and deep drawer

Sottolavello 60

60 cm sink unit

Lavello ad incasso 86 x 50 1 vasca inox

86x50 cm built-in sink with 1 stainless steel bowl

Top 240 P 61 in laminato H 4

240 cm laminate worktop D 61 H 4

Pensile 60 H 72

60 cm wall unit H 72

Cappa 60 aspirante estraibile H 63

60 cm hood slide-out ducting H 63

Pensile 60 H 72

60 cm wall unit H 72

Scolapiatti 60 H 72

60 cm plate rack H 72

Asta appendipensili ml 4

4 lm wall unit fixing strip

(Elettrodomestici Hotpoint)
(Hotpoint appliances)

VERSIONI VERSIONS

BRIDGE

fascia "A"

band "A"

fascia "B"

band "B"

HEAD

fascia "A"

band "A"

fascia "B"

band "B"

COMPOSIZIONE L 420

COMPOSITION W 420

COMPONENTI COMPONENTS

Colonna 60 H 217 frigo-freezer 315 classe A+

60 cm column H 217 fridge-freezer 315 class "A+"

Colonna 60 H 217 forno multifunzione inox

60 cm column H 217 for stainless steel multifunctional oven

Base 60

60 cm base unit

Piano cottura 75 5 gas inox con valvola

75 cm stainless steel hob with 5 burners with safety valve

Base 90 2 cassetti e cestone predisposta piano cottura

90 cm base unit with 2 drawers and deep drawers configured for hob

Base 60

60 cm base unit

Sottolavello 90

90 cm sink unit

Lavello ad incasso 86 x 50 1 vasca inox

86x50 cm built-in sink with 1 stainless steel bowl

Top 300 P 61 in laminato H 4

300 cm laminate worktop D 61 H 4

Pensile 60 H 72

60 cm wall unit H 72

Cappa 90 "STILO SMART" inox

90 cm "STILO SMART" stainless steel hood

Pensile 60 H 72

60 cm wall unit H 72

Scolapiatti 90 H 72

90 cm plate rack H 72

Asta appendipensili ml 4

4 lm wall unit fixing strip

(Elettrodomestici Hotpoint)
(Hotpoint appliances)

VERSIONI VERSIONS

BRIDGE

fascia "A"

band "A"

fascia "B"

band "B"

HEAD

fascia "A"

band "A"

fascia "B"

band "B"